

CLEANING & CARE

- Wipe regularly with a dry cloth.
- It is not recommended to use furniture polish or sprays.
- Spillages should be removed immediately using a damp cloth, then dried thoroughly.
- Do not use abrasive cleaners.
- Do not use chemical cleaners.
- Always use heat proof placemats or coasters to protect the surface.
- Do not position your furniture in front of radiators, fires or direct sources of heat.
- Do not stand or sit on this product.
- Retain these instructions for reference.

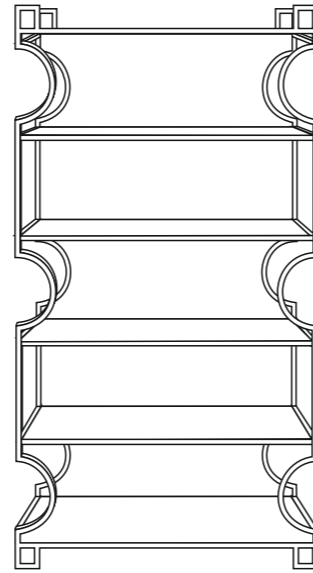

RF
RENOVATION
FACTORY

F11002315702700

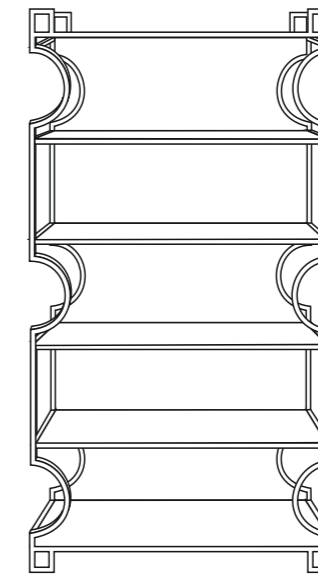

ASSEMBLY INSTRUCTIONS

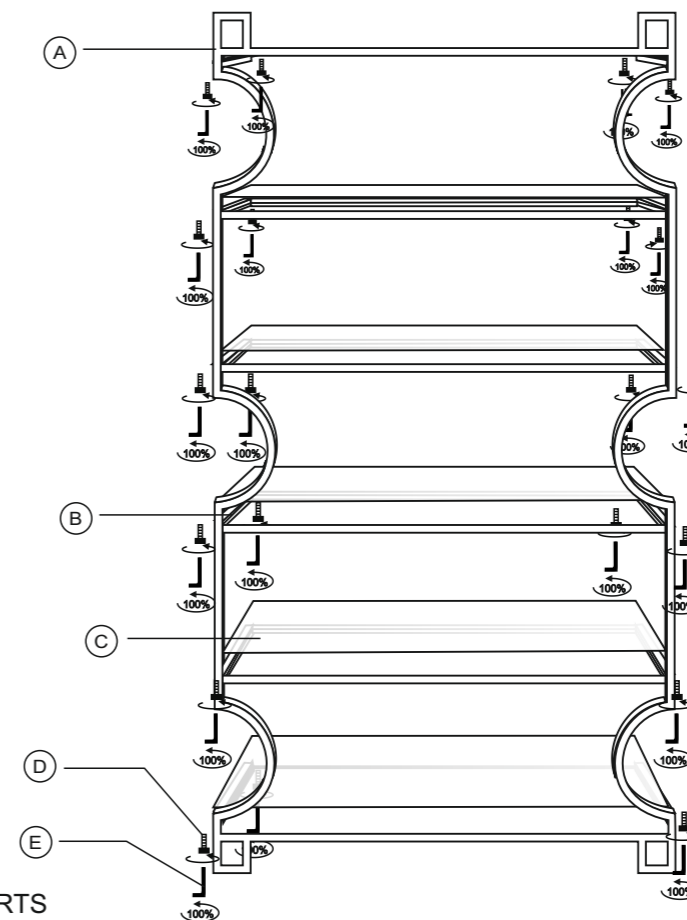

PARTS

A		Metal Frame	2
B		Metal Pipe Connector	12
C		Glass	6
D		Screw (Hardware Bag)	24
E		Allen Key (Hardware Bag)	1

STEP 1

Assemble one side metal frame with metal pipe connector using short screws. Secure all screws tightly by using Allen Key.

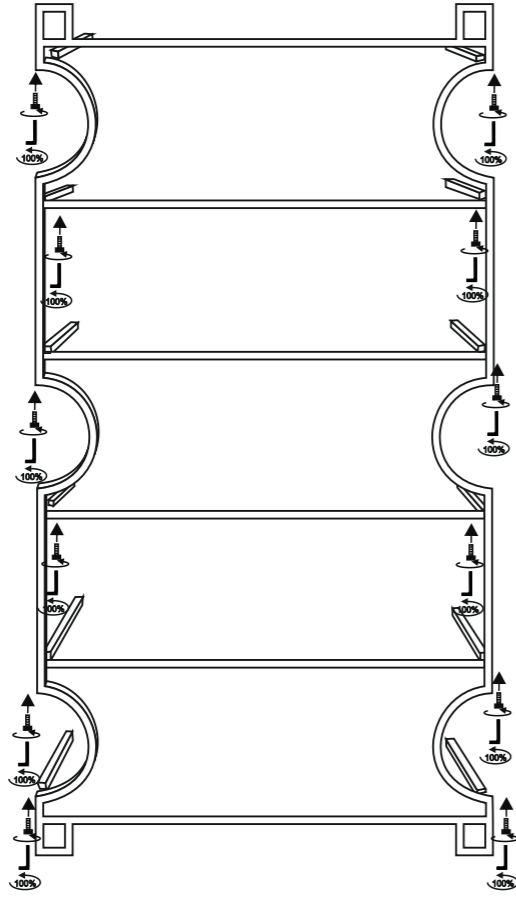

STEP 3

Place the glass carefully on the soft transparent tabs pasted on the metal frame.

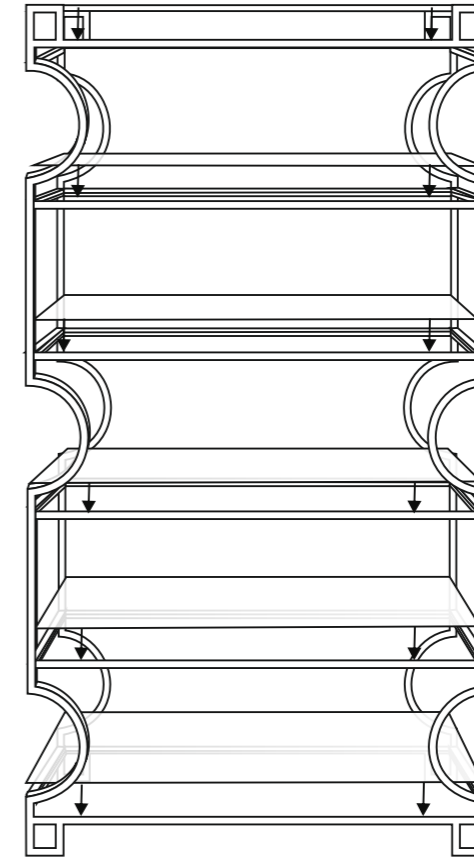

STEP 2

Assemble the other side metal frame with metal pipe connector using short screws. Secure all screws tightly by using Allen Key.

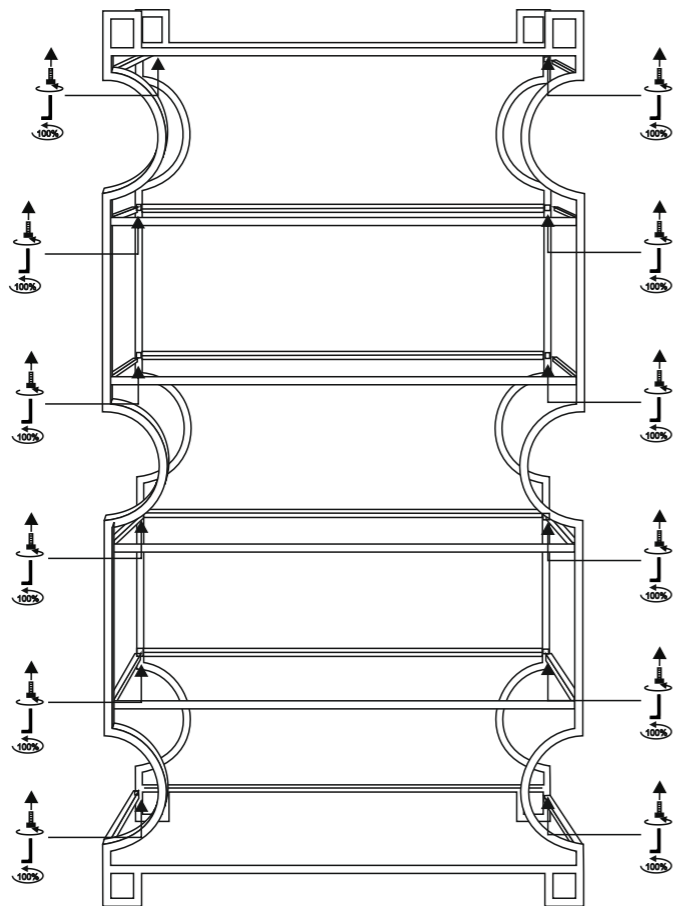

Final product image.

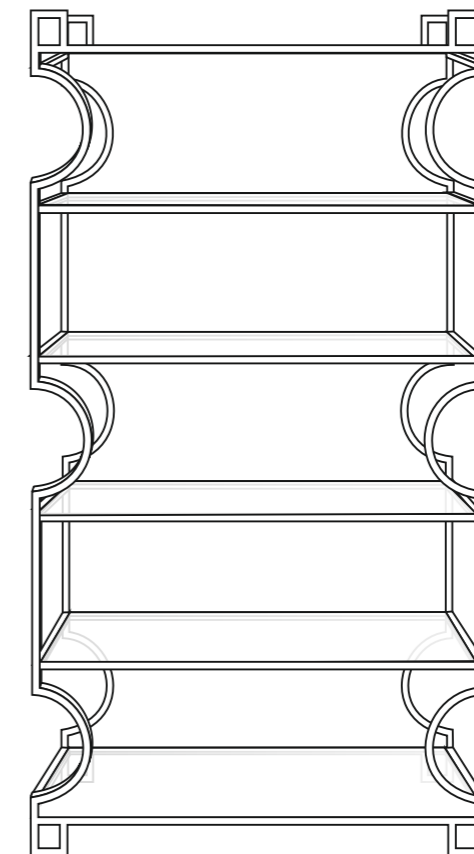

Now your product is ready for use.