

CLEANING & CARE

- Wipe regularly with a dry cloth.
- It is not recommended to use furniture polish or sprays.
- Spillages should be removed immediately using a damp cloth, then dried thoroughly.
- Do not use abrasive cleaners.
- Do not use chemical cleaners.
- Always use heat proof placemats or coasters to protect the surface.
- Do not position your furniture in front of radiators, fires or direct sources of heat.
- Do not stand or sit on this product.
- Retain these instructions for reference.

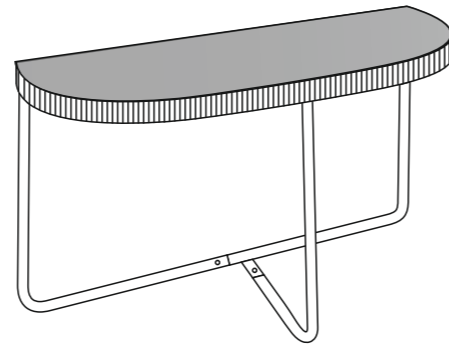

RF
RENOVATION
FACTORY

F05001148415000

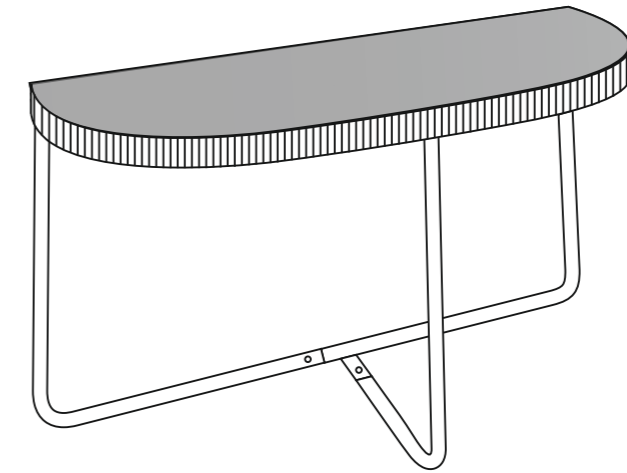

ASSEMBLY INSTRUCTIONS

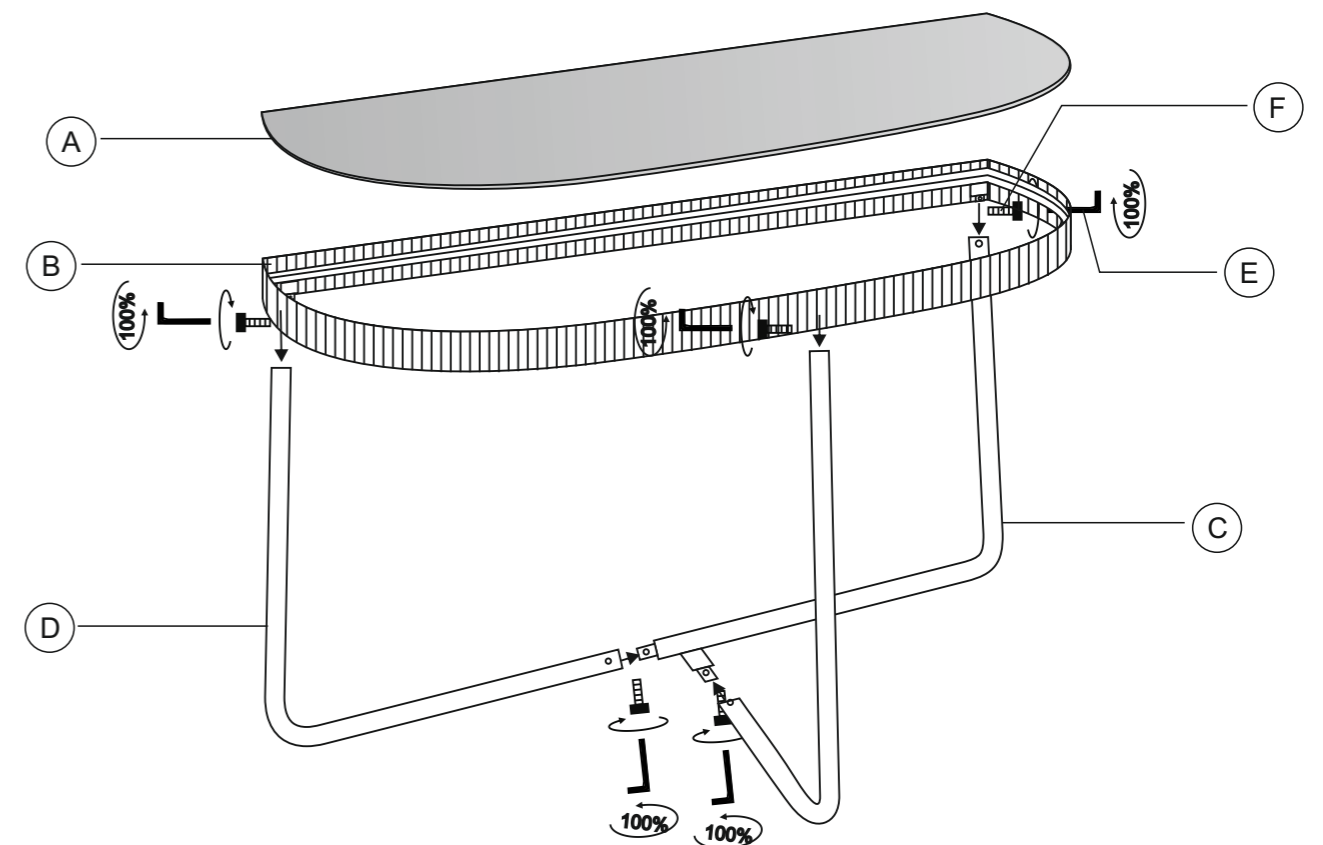

PARTS

A		Glass	1
B		Top Metal frame	1
C		Metal Pipe Connector	1
D		Metal Pipe Frame	2
E		Screw (Hardware Bag)	5
F		Allen key (Hardware Bag)	1

STEP 1

Assemble the metal pipe frame with metal pipe connector using short secure all screws tightly by using Allen Key.

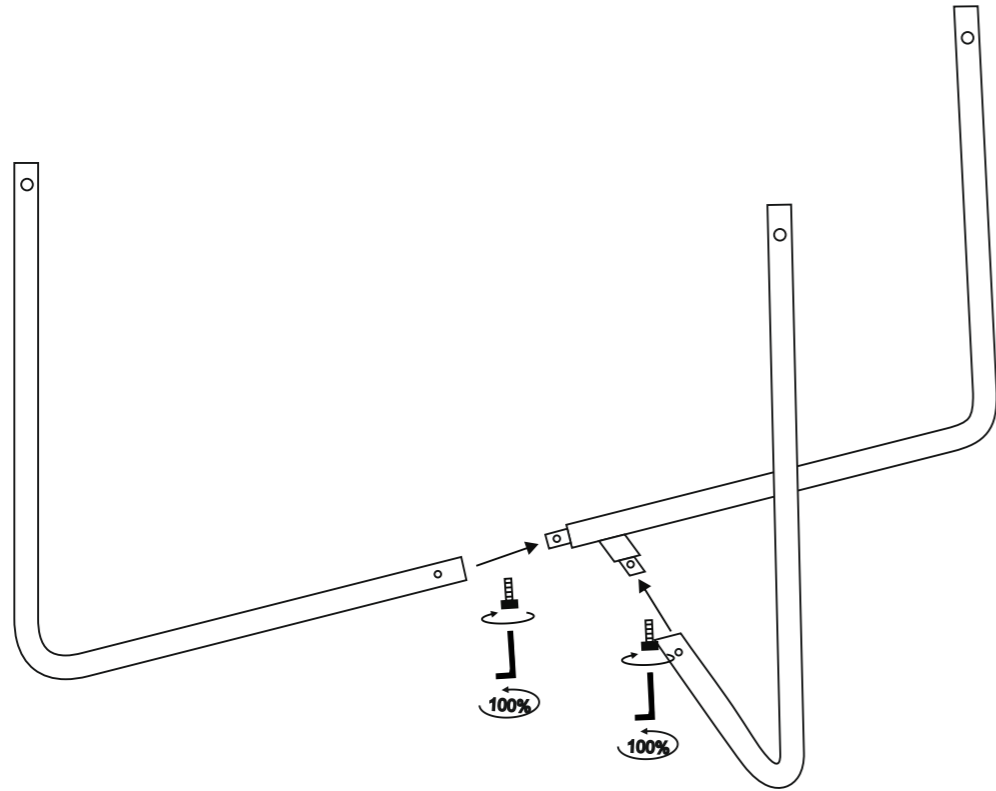

STEP 3

Place the glass carefully on the soft transparent tabs pasted on the metal frame.

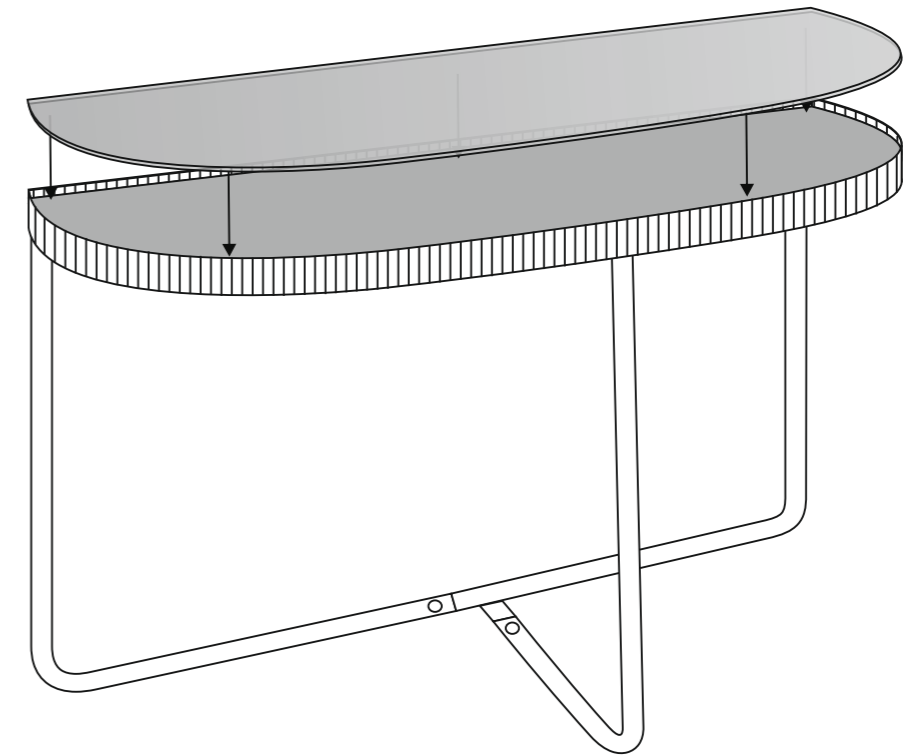

STEP 2

Assemble the top metal connector with metal pipe frame using short secure all screws tightly by using Allen Key.

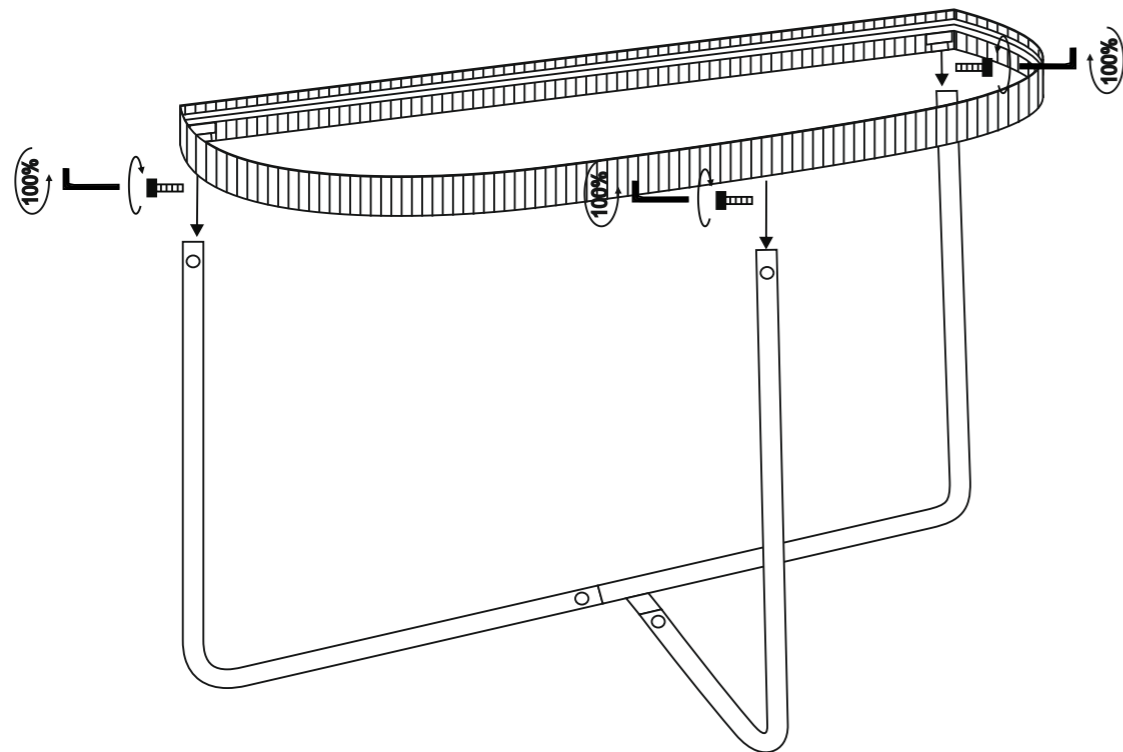

Final product image.

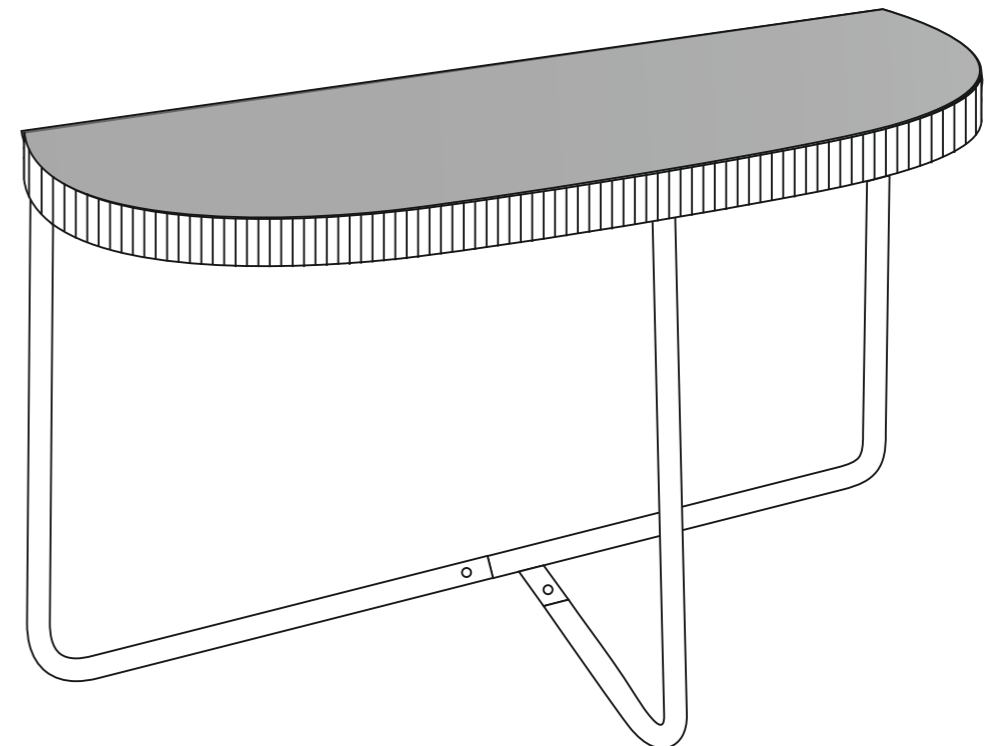

Now your product is ready for use.