

## CLEANING & CARE

- Wipe regularly with a dry cloth.
- It is not recommended to use furniture polish or sprays.
- Spillages should be removed immediately using a damp cloth, then dried thoroughly.
- Do not use abrasive cleaners.
- Do not use chemical cleaners.
- Always use heat proof placemats or coasters to protect the surface.
- Do not position your furniture in front of radiators, fires or direct sources of heat.
- Do not stand or sit on this product.
- Retain these instructions for reference.

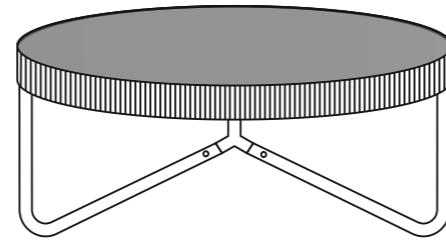

**RF**  
RENOVATION  
FACTORY

F03003748415000

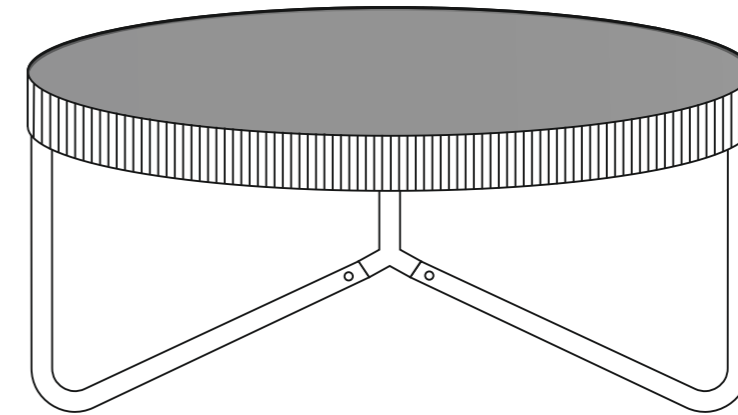

## ASSEMBLY INSTRUCTIONS

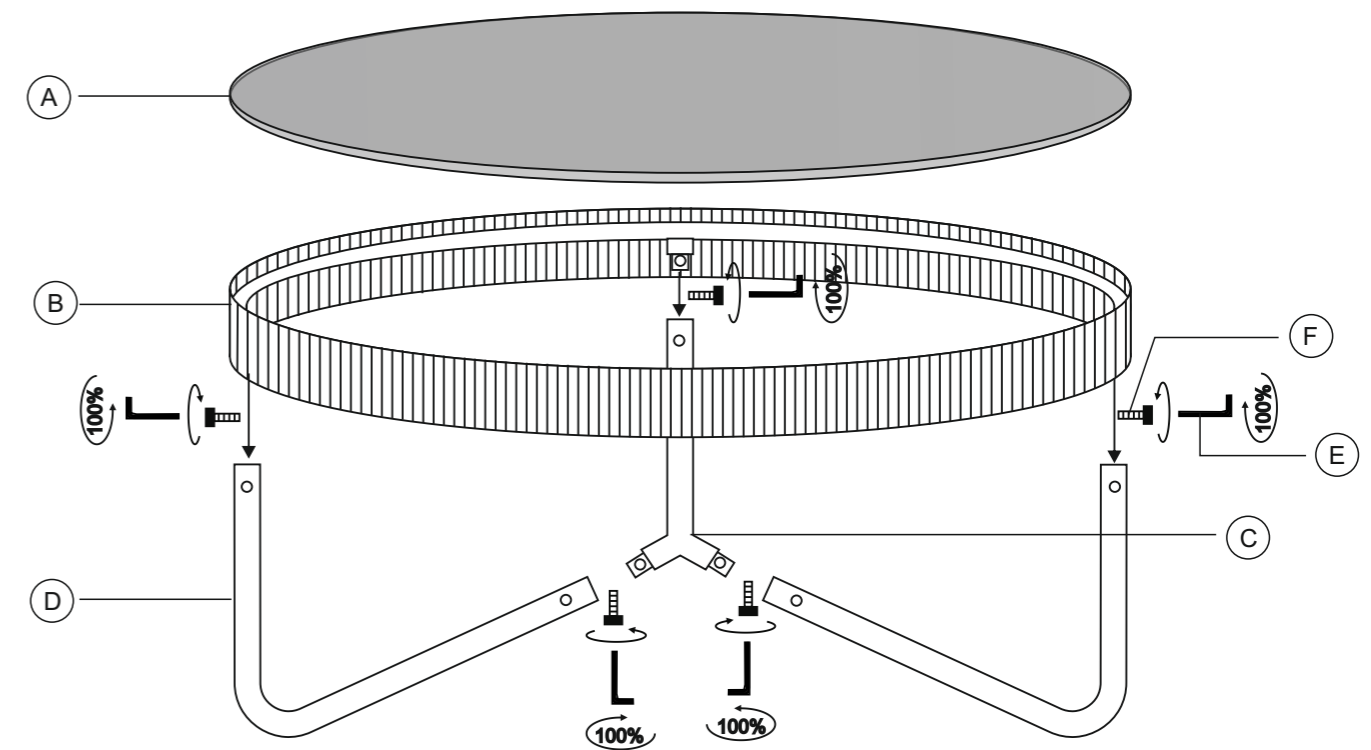

## PARTS

|   |  |                             |   |
|---|--|-----------------------------|---|
| A |  | Glass                       | 1 |
| B |  | Top Metal frame             | 1 |
| C |  | Metal Pipe Connector        | 1 |
| D |  | Metal Pipe Frame            | 2 |
| E |  | Screw<br>(Hardware Bag)     | 5 |
| F |  | Allen key<br>(Hardware Bag) | 1 |

STEP 1

Assemble the metal pipe frame with metal pipe connector using short secure all screws tightly by using Allen Key.

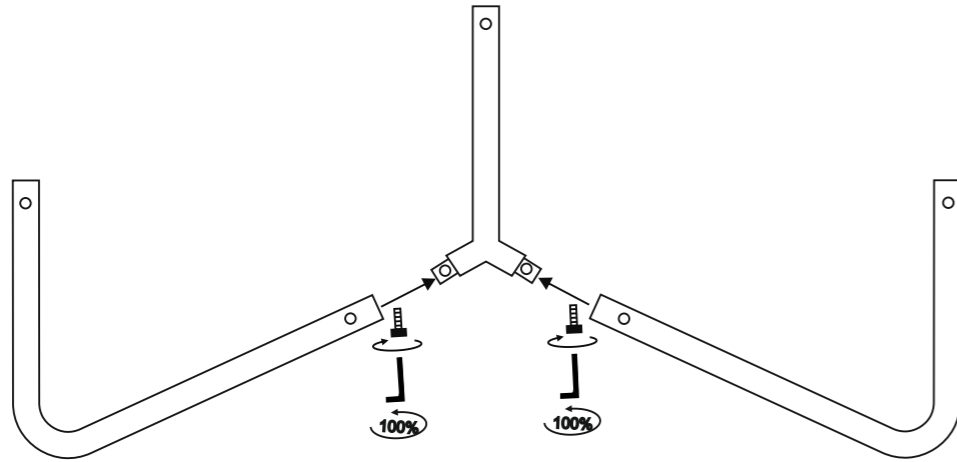

STEP 3

Place the glass carefully on the soft transparent tabs pasted on the metal frame.

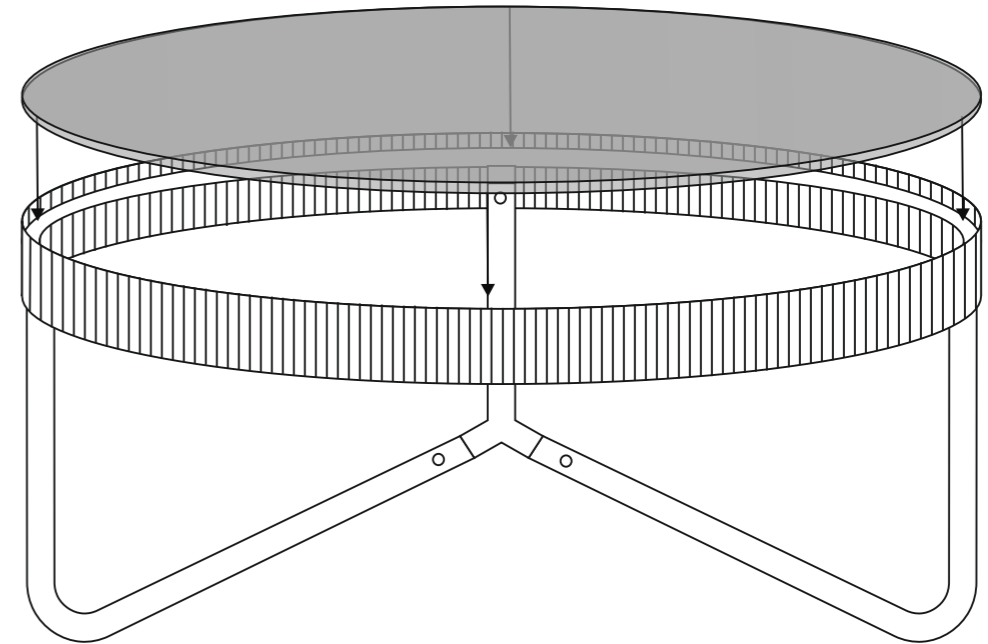

STEP 2

Assemble the top metal connector with metal pipe frame using short secure all screws tightly by using Allen Key.

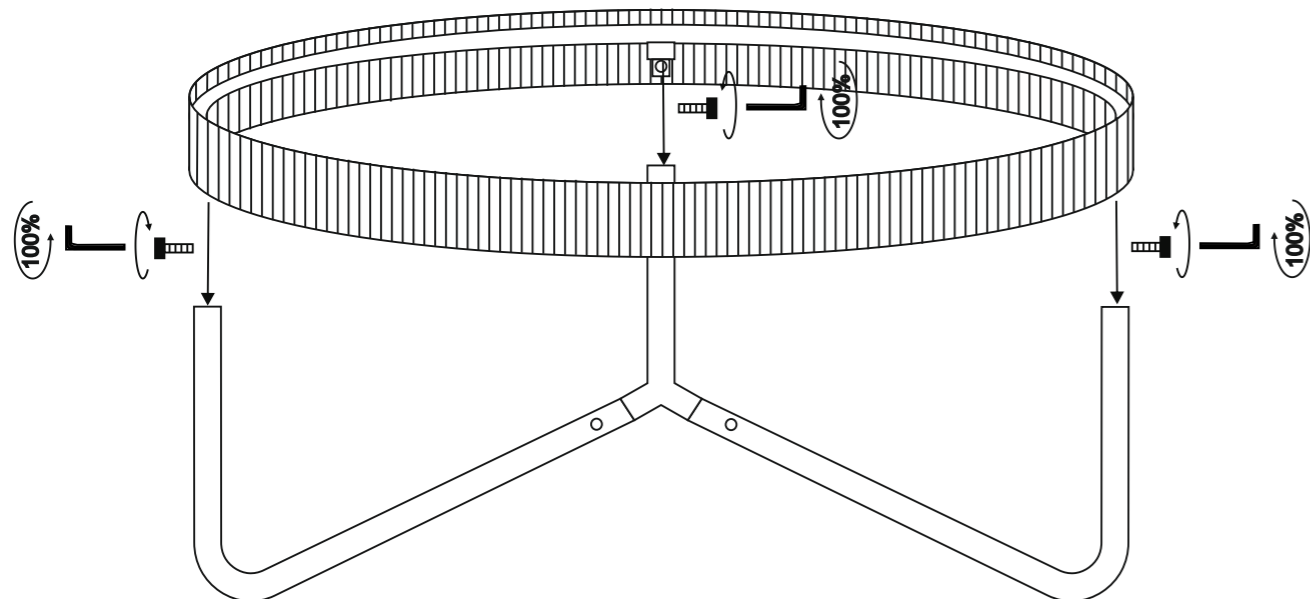

Final product image.

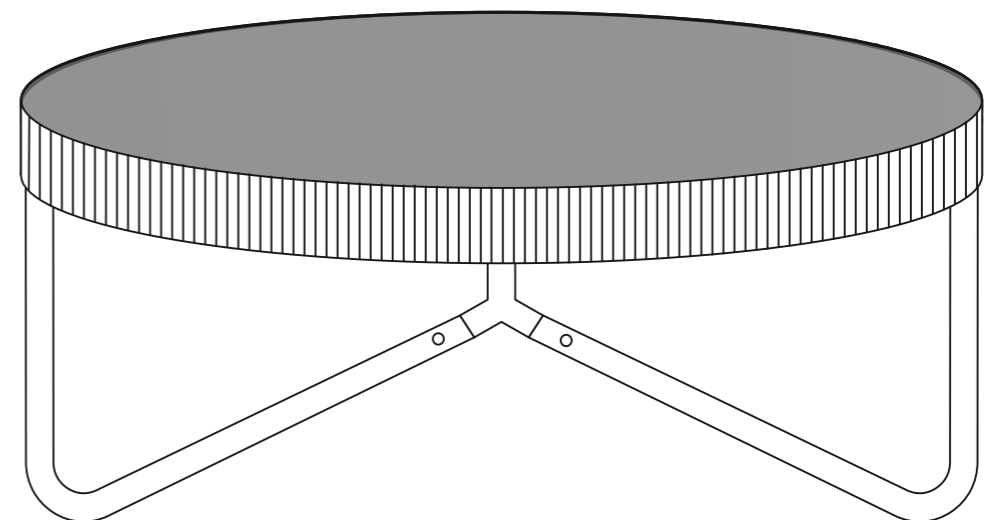

Now your product is ready for use.