

# KAIA

## RIO

### INSTALLATION MANUAL

#### RIO

In Suspension

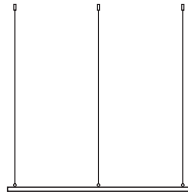

Ø 35.43"

Type Suspension light  
Material Solid brass, acrylic  
Environment Indoors  
Cable/Wire Length 118.11" (brass wire)  
Dimensions Ø 35.43 x 1.06 x 0.98"  
Weight 11.02 lb  
Certification IP20 CE; ETL US/CSA Canada  
Lamping LED technology, 24 V\*, Warm White  
2700 K, 5030 lm, Energy Class A;  
Lifetime 60 000 h

LED Watt 42 W

#### RIO

Out Suspension

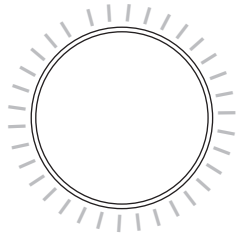
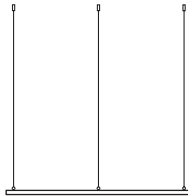

Ø 35.43"

Type Suspension light  
Material Solid brass, acrylic  
Environment Indoors  
Cable/Wire Length 118.11" (brass wire)  
Dimensions Ø 35.43 x 1.06 x 0.98"  
Weight 11.02 lb  
Certification IP20 CE; ETL US/CSA Canada  
Lamping LED technology, 24 V\*, Warm White  
2700 K, 4070 source lumens,  
Energy Class A; Lifetime 60 000 h.

LED Watt 42 W

#### RIO

In Suspension  
Small

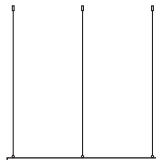

Ø 27.56"

Type Suspension light  
Material Solid brass, acrylic  
Environment Indoors  
Cable/Wire Length 118.11" (brass wire)  
Dimensions Ø 27.56 x 1.06 x 0.98"  
Weight 8.82 lb  
Certification IP20 CE; ETL US/CSA Canada  
Lamping LED technology, 24 V\*, Warm White  
2700 K, 3166 source lumens,  
Energy Class A; Lifetime 60 000 h.

LED Watt 32 W

## INSTALLATION

Before commencing installation ensure the relevant mains supply has been safely isolated/disconnected. Installation shall be carried out by a qualified electrician only. Ensure all electrical connections are tight with no loose strands, including factory made connections. The mains power must only be switched on once the fitting has been electrically connected to the driver.

Before installation it needs to be guaranteed that the existing ceiling/wall construction is suitable for the weight of the installed chandelier.

### STEP 1 - 2

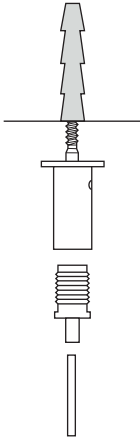

### STEP 3

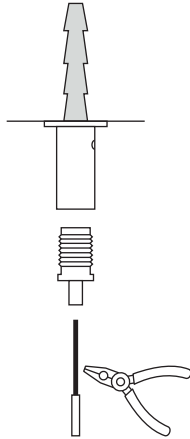

### STEP 4

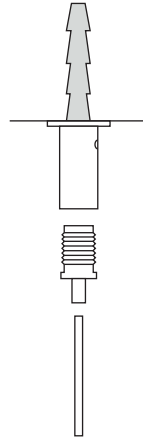

1. Unscrew the main body from the threaded mounting block and mount on the ceiling.
2. Secure the threaded mounting block in place with the screw provided.
3. Pull the brass cable coating by 3-5 cm and cut off the plastic cover.
4. Push the brass cable coating back to position.
5. Pass through wire rope firmly into the main body until it locks in place.
6. Screw wire rope into the rope fixing.

### STEP 5

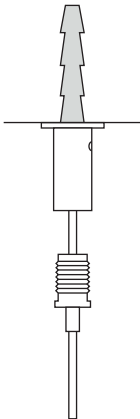

### STEP 6

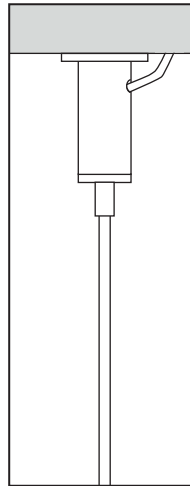
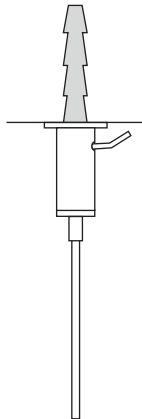

## RIO

### Mounting Options

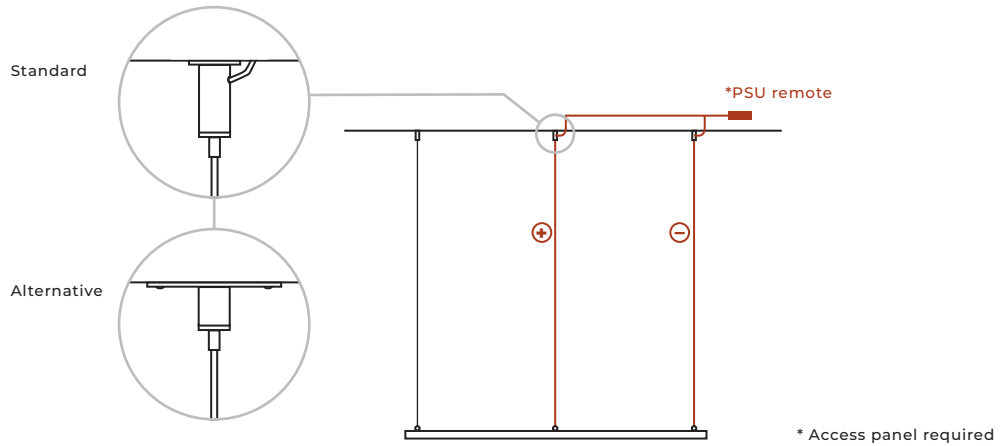

**ATTENTION** | Wire marked with red is conducting.

The maximum distance from the linear led of the ring to the PSU is 9,5 ft.  
For any longer distance please contact [sales@kaialighting.com](mailto:sales@kaialighting.com).

## CARE INSTRUCTIONS

1. Use a soft dry cloth to ensure a fingerprint free surface. We recommend the use of micro fibre cloths.
  2. Warning: do not use alcohol or other solvents for cleaning.
- For further information see attached care instructions.

## DIMMING OPTIONS

Dimming options are available on request (Phase Cut, Bluetooth (Casambi), 1-10 V, Dali, RemoteControl). Optional: Dim to warm, 2500 - 3000K - for more information please contact [sales@kaialighting.com](mailto:sales@kaialighting.com). Lighting control system specifications should be clarified before placing the order.

\* Chandelier comes with an external power supply unit as a standard; dimming is optional. Please contact [sales@kaialighting.com](mailto:sales@kaialighting.com) for further information on dimmers, transformers etc. Please note KAIA Ltd cannot take any responsibility for the connection with your dimming or central control system. It is the customer's responsibility to ensure the compatibility with their systems.

\*\* Lighting fixtures designed for the indoor environment up to 75° F.

## INSTALLATION MANUAL | ANNEX

### CABLE HOLDER TYPE 15

The cable holders (in German "DSH"= Drahtseilhalter) of the Type 15 series are grip gliders for wire ropes that are available in a variety of designs. The cable holders are conceived for the suspension of different, clearly defined working loads on steel cables (wire ropes); the table on page 2 provides details about maximum permissible loads (safe working loads/working load limits) and approved wire ropes. Safe use of this suspension system requires sufficiently firm attachment/anchorage to a fastening point (ceiling, wall, floor, object) – the responsibility lies with the user. Attachment/anchorage must always be performed by a qualified professional installer.

### SAFETY ADVICE / PRECAUTIONARY WARNING

1. It is only permissible to use Reutlinger DSH within interiors at temperatures between -4°F and +122°F.
2. The use of the DSH in and near swimming pools (a chlorine-filled atmosphere) or any other location with a high corrosion potential (sea water or high-salt concentration atmosphere) is not permissible.
3. Any dynamic forces acting on the cable holder during assembly and disassembly must be taken into account for determining the maximum permitted load capacity. The indicated safe working load (working load limit) must never be exceeded! Cable holders are not approved for use with stage machinery installations designed to perform dynamic movements. 4. The casing of the DSH should not be able to be opened, and should not be opened.
4. The casing of the DSH should not be able to be opened, and should not be opened. Permanently fixed original parts are not to be dismantled.
5. Before usage, the nozzle of the DSH must be able to be pressed in with ease, against the pressure of the spring, and should move back unaided into its original position.
6. The feeder channel of the nozzle, in order to enable the correct function of the DSH, is required to be free of any foreign particles.
7. When looking through the nozzle, three or six balls should be visible, parts of their circumferences protrude into the feeder channel of the nozzle (see pic.1 & 1a). The lighter, central gap between the balls creates a star with three or six points. If there are not three or six balls in the DSH, it is not to be used and Reutlinger GmbH Quality Control should be contacted.
8. The wire rope to be threaded into the DSH should be closed or sealed (tinned, welded, with shrink sleeving or the like) so that an unravelling of the wire rope and an injury to the user from projecting wires or strands is avoided. When shortening the wire rope, the ends need to be once again permanently sealed.
9. In order to achieve the full loading performance of the DSH, the wire ropes need to be undamaged and free of any contamination.
10. Wire ropes and wires should not be pulled over edges (e.g. a side exit).
11. The angle with which the wire rope may be diverted from the symmetrical axis of the DSH should not exceed  $\alpha=5^\circ$  (see pic. 2)
12. The nozzle of the DSH should under no circumstances be loaded (bent sharply or be put under pressure) and must remain free and accessible at all times.
13. DSH must be used, at a minimum, in pairs, i.e. the object to be hung must be held by a minimum of two wire ropes in order to avoid the turning of the DSH upon its own axis on the wire rope.
14. Following a loading of a DSH above the permitted maximum work load, it is not to be used again.

15. Wire ropes and DSH must not be damaged.

15.1 The following are defined as critical damage (but not exclusively):

Cracks, deformations or material denudation such that may occur through impact, knocking or heavy friction. Slight deformation of or denudation to the nozzle may indicate a possible damage to the interior of the DSH which may have been caused by a knock to the nozzle (by a fall on to a hard surface for example).

15.2 Regarding queries concerning whether a particular case involves uncritical marks of usage or a possible critical damage, please contact Reutlinger GmbH Quality Control for safety purposes.

16. No tool is to be used when mounting the DSH onto its complementary part or when tightening the lock nut

17. A hinged DSH (see pic. 3) must not be angled and then used as a lever when being fitted to its complementary part.

18. A forked DSH (see pic. 4) must be securely locked with the spring of the safety bolt.

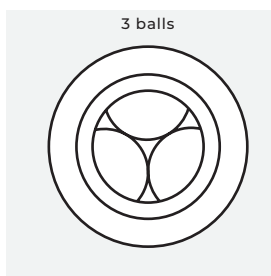

**PIC. 1**  
view through the nozzle

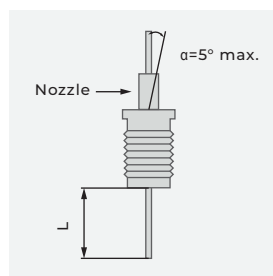

**PIC. 2**  
diversion from the axis

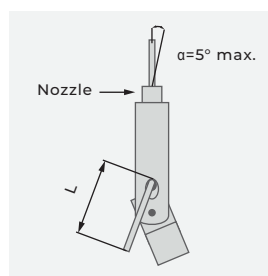

**PIC. 3**  
hinged DSH

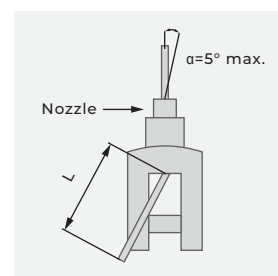

**PIC. 4**  
forked DSH

## CONNECTING THE DSH TO A WIRE ROPE:

1. Various designs of DSH can be additionally fitted with a lock nut which is threaded on to the so called 'nozzle' of the DSH. Prior to the insertion of a wire rope, the lock nut is loosened to the end of the thread. The end of the wire rope is then inserted into the nozzle against the slight resistance of the spring supported nozzle (see pic.5).

2. The DSH can now be slid up upon the wire rope and as soon as it is pulled in the opposing direction or loaded, the gripping mechanism is set into action. In the case that the gripping mechanism does not grip, it must be checked whether it is in fact the correct wire rope that is being used (for example with a diameter of at least 1.0mm), or whether the DSH is possibly defective (in order to test the DSH prior to use, please see safety advice steps 1-7). Upon suspicion of a defective part, the DSH in question may not be used and Reutlinger GmbH Quality Control should be contacted immediately.

3. Care should be taken that the wire rope, prior to the gripping action occurring, is fed sufficiently through the DSH so that it is once again visible by at least  $L = 2.5\text{cm}$  (1 inch) at the lower end (connecting thread / connecting part) or out of the side exit (ZW) (see pic.6+7) when the DSH is loaded. In addition the angle  $\alpha = 5^\circ$  max. between the wire rope and the vertical/symmetrical axis of the DSH at the point of exit from the nozzle may not be exceeded (see pic.6+7). When greater angles are used, sideward pressure from the wire rope on the nozzle can cause damage or disturb the function leading to a possible unintended release of the gripping mechanism.

4. Y-holders may have the max. angle of spread  $\alpha = 90^\circ$ . Vertical and Y wire ropes should both have the same diameter (see pic.6)

5. The angle  $\gamma = 30^\circ - 90^\circ$  should not be exceeded when holders are attached to sloping ceilings (see pic.7)

6. After the DSH has been adjusted to the required position on the wire rope by light hand movement, it will begin to grip.

7. As soon as the DSH has been correctly gripped by the wire rope, the lock nut is to be tightened by hand (without the use of tools!) until it rests at the head of the DSH. The permitted load can now be attached to the DSH, the gripping force of the DSH increases proportional to the work load. Care should be taken to ensure that the load attached to the tensed wire rope is slowly and continuously added.

8. Following the attachment of the work load, the lock nut is further tightened by hand (without the use of tools!) until it rests on the DSH.

9. An impulse load (a sudden loading) may lead to the exceeding of the max. permitted work load and thus may lead to potential damage of the cable and the DSH. Following the occurrence of an impulse load (sudden loading) the load should be removed and the wire rope as well as the DSH checked for damage immediately.

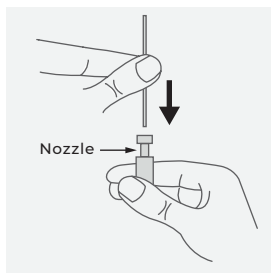

**PIC. 5**  
wire insert

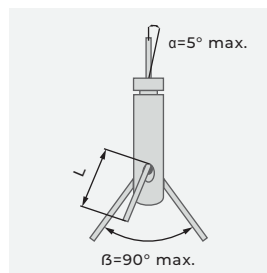
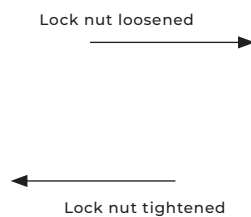

**PIC. 6**  
Y-DSH with side exit

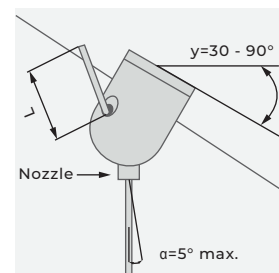

**PIC. 7**  
sloped ceilings

If the DSH or load is to be set at a new position along the wire rope, one proceeds in reverse order:

1. The lock nut is loosened, then the DSH should be relieved of the load, whereby the load should either be removed or secured by an expert to ensure against the unintentional dropping of the load.
2. The plunger with the lock nut is pressed into the DSH and held down by hand. The DSH has now been released!
3. The DSH is slid to the required position on the wire rope.
4. The lock nut is released once again, the nozzle should then move unaided, back out of the DSH into its original position.
5. In order to reload, proceed once again as shown from step 6.

In accordance with Directive 2006/42/EC on machinery the following maximum working loads apply. (SAFETY FACTOR = 5)

WIRE ROPE Ø	Galvanised steel wire rope 7x7 - similar DIN EN 12385-4:2008, spec. tensile strength 2300N/mm2	Stainless steel wire rope 7x7 - similar DIN EN 12385-4:2008, spec. tensile strength 1570 N/mm2
Ø 0.04"	28.66 lb	22.05 lb
Ø 0.05"	37.48 lb	33.07 lb
Ø 0.06"	55.12 lb	44.09 lb

**IMPORTANT** | Please retain this instruction manual in a generally accessible place for later reference.