

KAIA

RIO

INSTALLATION MANUAL

RIO
In and Out
Pendant

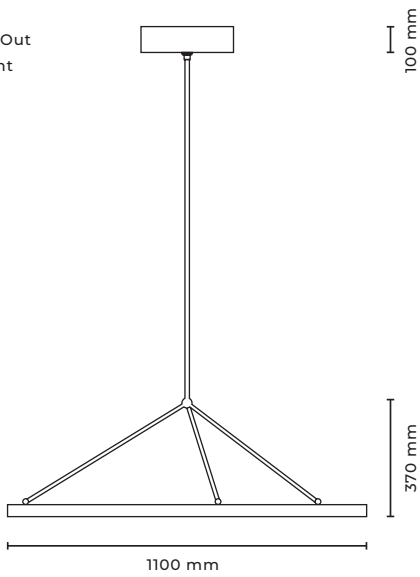

RIO
In / Out
Pendant

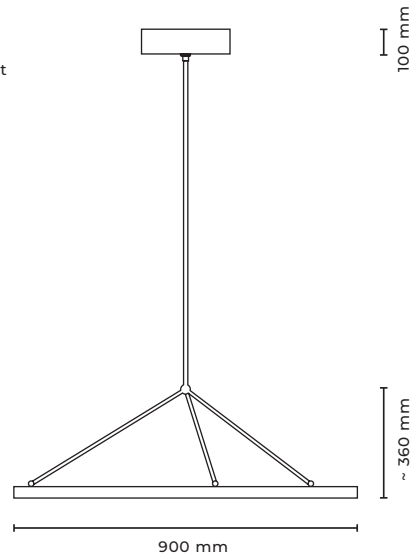

RIO
In and Out
Pendant

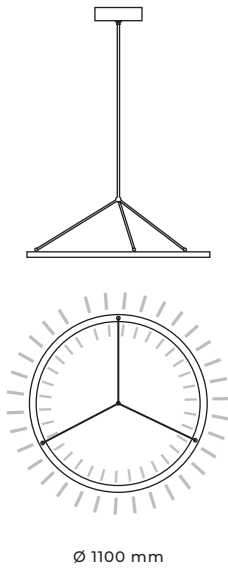

Type	Pendant light
Material	Solid brass, acrylic
Environment	Indoors
Drop	1000 mm stem, overall drop 1470 mm. Can be customized.
Dimensions	Ø 1100 x 47 x 34 mm
Weight	10,5 kg
Ceiling rose	Ø 270 x 75mm
Certification	IP20 CE
Lamping	LED technology, 24 V*, Warm White 2700K, 5540 lm, Energy Class A; Lifetime 60 000 h.
LED Watt	63 W

RIO

In Pendant

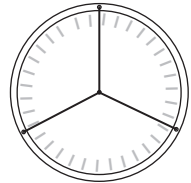
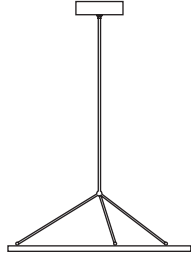

Ø 900 mm

Type
Material
Environment
Drop
Dimensions
Weight
Ceiling rose
Certification
Lamping

Pendant light
Solid brass, acrylic
Indoors
1000 mm stem, overall drop 1470 mm.
Can be customized.
Ø 900 x 27 x 25 mm
5 kg
Ø 270 x 75mm
IP20 CE
LED technology, 24 V*, Warm White
2700K, 4070 lm, Energy Class A;
Lifetime 60 000 h.

LED Watt

42 W

RIO

Out Pendant

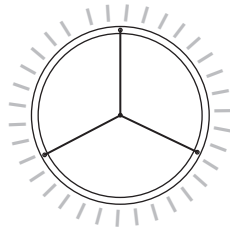
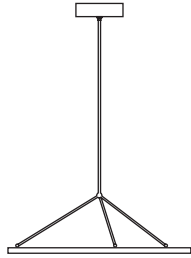

Ø 900 mm

Type
Material
Environment
Drop
Dimensions
Weight
Ceiling rose
Certification
Lamping

Pendant light
Solid brass, acrylic
Indoors
1000 mm stem, overall drop 1470 mm.
Can be customized.
Ø 900 x 27 x 25 mm
5 kg
Ø 270 x 75mm
IP20 CE
LED technology, 24 V*, Warm White
2700K, 4070 lm, Energy Class A;
Lifetime 60 000 h.

LED Watt

42 W

INSTALLATION

Before commencing installation ensure the relevant mains supply has been safely isolated/disconnected. Installation shall be carried out by a qualified electrician only. Ensure all electrical connections are tight with no loose strands, including factory made connections. The mains power must only be switched on once the fitting has been electrically connected to the driver.

1. Fix the base plate to the mounting surface using 4 No. 4mm screws. Ensure the fixing points can support the weight of the fixture.
2. Feed the cables through the stem
3. Tighten the stem firmly onto the top ball.
4. Feed the cables and the stem through the ceiling rose top.
5. Tighten the stem firmly onto the base plate. Connect the unit to the mains. Please refer to Dimmer Unit installation manual if you connect the fitting to the dimming system.
6. Lastly fix the ceiling rose with the knurled screw. Tighten slightly!

STEP 1

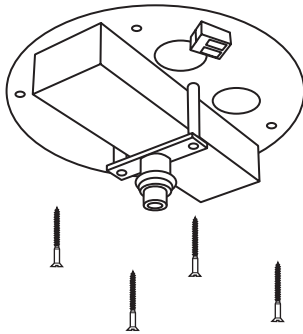

pitch circle
diameter 225mm;
3x120°

STEP 2

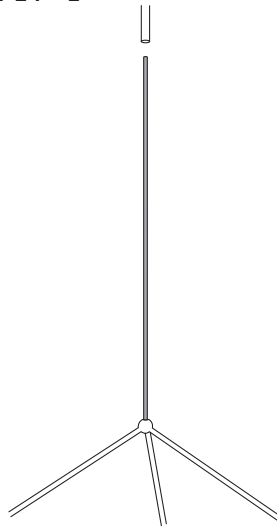

STEP 3

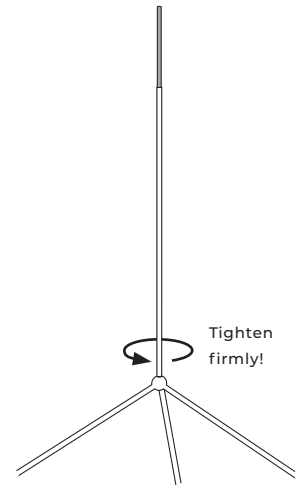

STEP 4

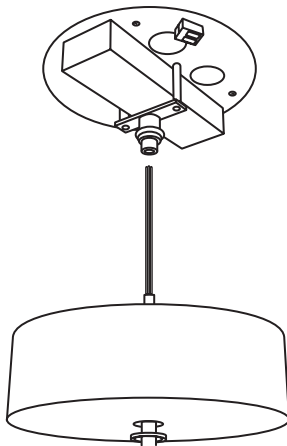

STEP 5

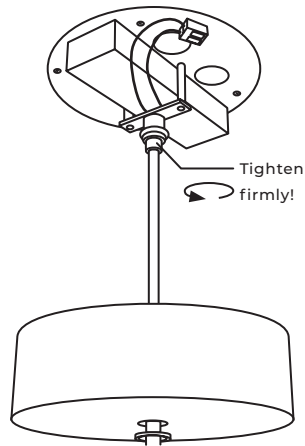

STEP 6

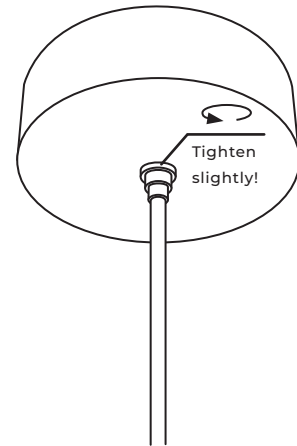

CARE INSTRUCTIONS

1. Use a soft dry cloth to ensure a fingerprint free surface. We recommend the use of micro fibre cloths.
 2. Warning: do not use alcohol or other solvents for cleaning.
- For further information see attached care instructions.

DIMMING OPTIONS

Dimming options are available on request (Phase Cut, Bluetooth (Casambi), 1-10 V, Dali, RemoteControl). Optional: Dim to warm, 2500 - 3000K - for more information please contact sales@kaialighting.com. Lighting control system specifications should be clarified before placing the order.

* Chandelier comes with an external power supply unit as a standard; dimming is optional. Please contact sales@kaialighting.com for further information on dimmers, transformers etc. Please note KAIA Ltd cannot take any responsibility for the connection with your dimming or central control system. It is the customer's responsibility to ensure the compatibility with their systems.

** Lighting fixtures designed for the indoor environment up to 24° Celsius.