

KAIA

ORA

INSTALLATION MANUAL

ORA

Single
Pendant

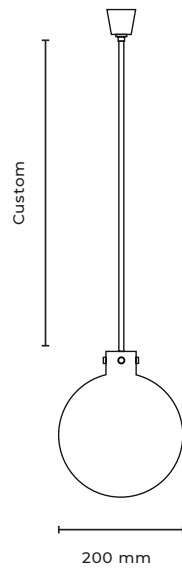

| | |
|---------------|--|
| Type | Pendant |
| Material | Brass |
| Environment | Indoors |
| Dimensions | Glass Ø 200 mm |
| Stem Length | customized |
| Weight | 2 Kg |
| Ceiling Rose | Ø 80 mm x 65 mm |
| Certification | IP20 CE |
| Lamping | Filament: E14 115mm Tube Light Bulb, clear, 25W, 2200 K, dimnable. OR Led: E14 115mm Tube Light Bulb, clear, 2.7 W (250lm), 2600K, dimnable |

* Please note the glass is mouth blown. The crystal glass might have some natural imperfections which are a result of the glass manufacturing process.

GLOVES

You have chosen an oiled and waxed finish for your lighting fixtures, please make sure that these will only be touched with provided gloves and that the Care Instructions will be followed strictly.

* Due to the manufacturing process, slight differences in the finish between the different brass parts, might occur.

** Lighting fixtures designed for the indoor environment up to 24 ° C.

INSTALLATION

Before commencing installation ensure the relevant mains supply has been safely isolated/disconnected. Installation should be carried out by a qualified electrician. Ensure all electrical connections are tight with no loose strands, including factory made connections. The Mains power must only be switched on once the fitting has been electrically connected to the driver.

STEP 1

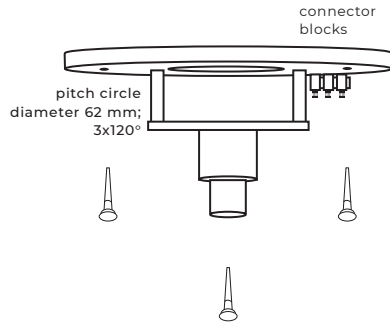

Fix the groundplate with screws to the ceiling.

STEP 2

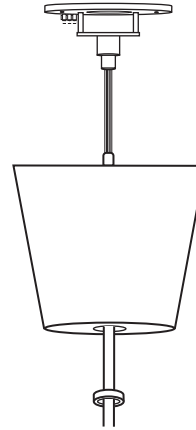

Put the stem through the ceiling rose.

STEP 3

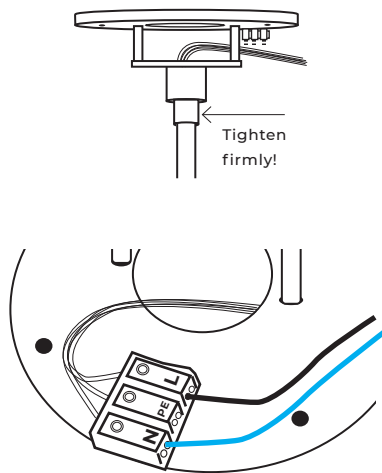

Thread the cables through the ball joint and screw the stem into the ball joint. After that connect the cable with the clamp on the groundplate.

STEP 4

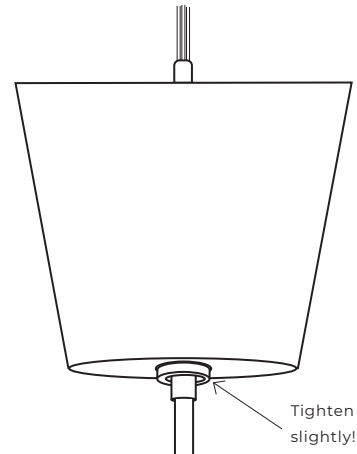

Lastly fix the ceiling rose with the knurled screw.

STEP 5

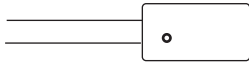

Adjust the adjustable screws to the glass ball opening. There has to be a minimum of 1 mm distance between the metal and the glass.

STEP 6

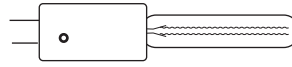

Screw in all bulbs, then switch on the circuit and test if the bulbs are functioning. With transportation the lampholders might get interfered and the bulb will not connect correctly. In this case please **disconnect the lighting fixture from the circuit**, bend the contact brackets slightly to ensure that the bulbs and the lampholder are connected.

STEP 7

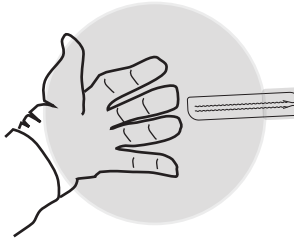

Carefully secure the glass sphere.

CAR INSTRUCTIONS

1. Use a soft dry cloth to ensure a fingerprint free surface. We recommend the use of micro fibre cloths.
2. Warning: do not use alcohol or other solvents for cleaning.

STEP 8

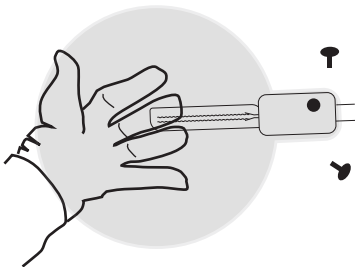

Carefully fix loosely with the supplied knurled-head screw by hand. Do not use a screw-driver. Do not screw too tightly, ensure there is at least 1 mm tolerance between the glass and the screw.

STEP 9

