

# KAIA

## INSTALLATION MANUAL

### NEA MARBLE

Wall / Ceiling  
50

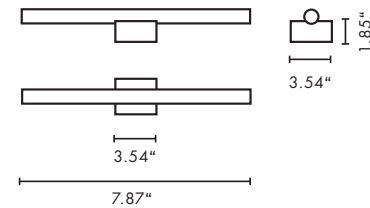

Type	Wall/ceiling light
Material	Marble/brass
Environment	Indoors
Dimensions	19.68" x 1.85"
Weight	2.20 lb
Certification	IP20 CE
Bathroom	Zone 3
US	110 V
Lamps	max. 60 W, S14d, our suggestion: 4.9 W, 1x linear opal LED, 2700 K, Mains (Phase) dimmable* EPREL ID 566201,522907

### NEA MARBLE

Wall / Ceiling  
30

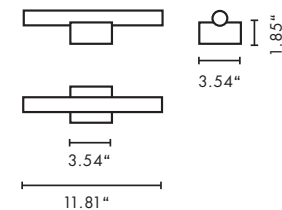

Type	Wall/ceiling light
Material	Marble/brass
Environment	Indoors
Dimensions	11.81" x 1.85"
Weight	2.20 lb
Certification	IP20 CE
Bathroom	Zone 3
US	110 V
Lamps	max. 60 W, S14d, our suggestion: 3,1 W, 1x linear opal LED, 2700 K, Mains (Phase) dimmable* EPREL ID 566201, 522905

## INSTALLATION

Before commencing installation ensure the relevant mains supply has been safely isolated/disconnected. Installation should be carried out by a qualified electrician. Ensure all electrical connections are tight with no loose strands, including factory made connections. The Mains power must only be switched on once the fitting has been electrically connected to the driver.

1. Remove the base from the installation bracket.
2. Mark the holes for the screws at the correct distances.
3. Connect the unit to the mains.
4. Affix the bracket to the wall with 4 screws (hole size max. 4 mm). Make sure the unit is mounted safely and fixed to the wall
5. Place the marble over the bracket and secure it with the two headless screws.
6. Place the lamp in the luminiere.

### STEP 1

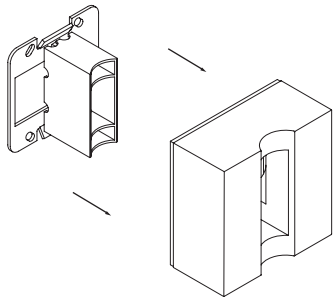

### STEP 2

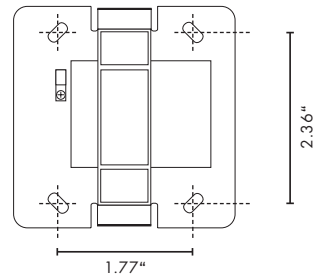

### STEP 3

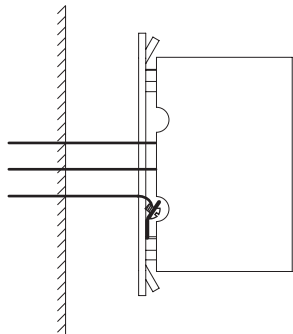

### STEP 4

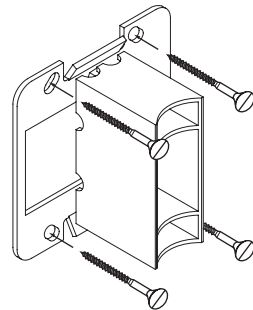

### STEP 5

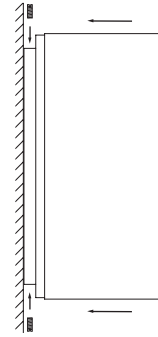

### STEP 6

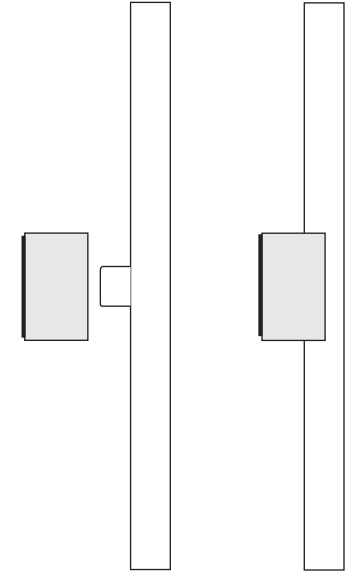

## LAMP INSTALLATION

- Before commencing installation ensure the relevant mains supply has been safely isolated/disconnected.
- Use supplied fabric gloves to prevent any stains on the surface of the lamp.
- Due to risk of glass fracture handle the lamp with care!
- Whilst applying pressure push the socket into the lamp holder in the marked place.  
Remove the lamp from the lamp holder carefully with both hands (see graphic).

## CARE INSTRUCTIONS

- Use a soft dry cloth to ensure a fingerprint free surface. We recommend the use of micro fibre cloths.
- Warning: do not use alcohol or other solvents for cleaning.

\* On very rare occasions, these lamps may appear to have a slight buzzing or flickering. As is the case with all retro LED lamps, this is likely caused by a number of outside influences such as incorrect installation, wiring, dimming or transformers and in some instances low electrical resistance.

\*\* Please contact [sales@kaialighting.com](mailto:sales@kaialighting.com) for further information on dimmers etc. Please note KAIA Ltd cannot take any responsibility for the connection with your dimming or central control system. It is the customer's responsibility to ensure the compatibility with their systems.