

K A I A

NEA

INSTALLATION MANUAL

NEA

Wall / Ceiling
50

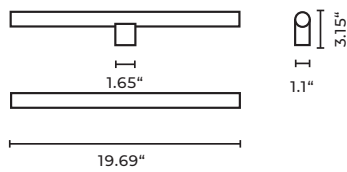

Type

Material

Environment

Dimensions

Weight

Certification

Bathroom

US

Lamps

Wall/ceiling light

Solid brass

Indoors

19.69 x 3.15"

0.66 lb

IP20 CE; ETL US/CSA Canada

Zone 3

110 V

Glass lamps not available.

Please inquire

NEA

Wall / Ceiling
30

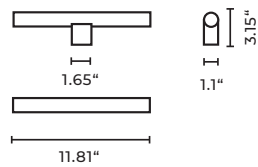

Type

Material

Environment

Dimensions

Weight

Certification

Bathroom

US

Lamps

Wall/ceiling light

Solid brass

Indoors

11.81 x 3.15"

0.66 lb

IP20 CE; ETL US/CSA Canada

Zone 3

110 V

Glass lamps not available.

Please inquire

STEP 1 FRONT VIEW

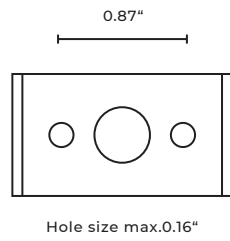

INSTALLATION

Before commencing installation ensure the relevant mains supply has been safely isolated/disconnected. Installation should be carried out by a qualified electrician. Ensure all electrical connections are tight with no loose strands, including factory made connections.

1. Remove the base from the installation bracket.
2. Affix the bracket to the ceiling/wall with 2 screws (hole size max. 0.16"). Connect the unit to the mains.
3. Fix the unit back on its base and tighten 2 screws on the side.
4. Place the lamp in the luminiere.

STEP 2 SIDE VIEW

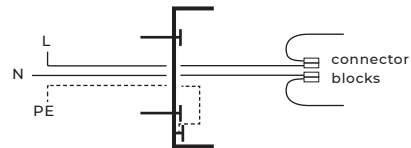
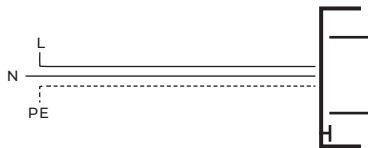

STEP 3 SIDE VIEW

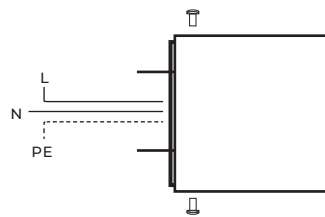
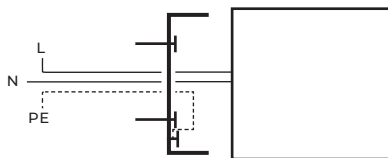

STEP 4 SIDE VIEW

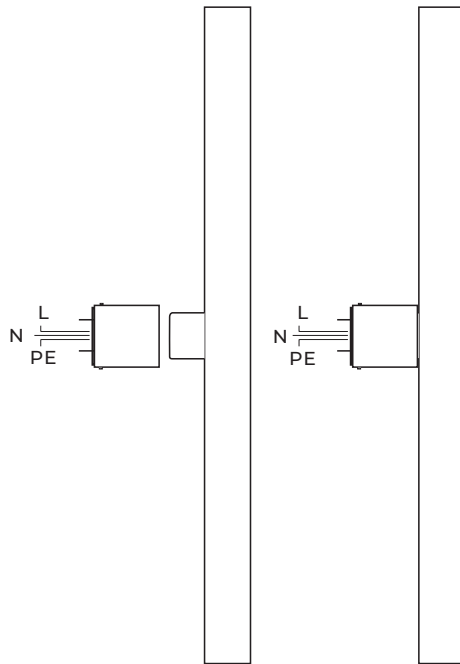

LAMP INSTALLATION

- Before commencing installation ensure the relevant mains supply has been safely isolated/disconnected.
- Use supplied fabric gloves to prevent any stains on the surface of the lamp.
- Due to risk of glass fracture handle the lamp with care!
- Whilst applying pressure push the socket into the lamp holder in the marked place. Remove the lamp from the lamp holder carefully with both hands (see graphic).

CARE INSTRUCTIONS

* On very rare occasions, these lamps may appear to have a slight buzzing or flickering. As is the case with all retro LED lamps, this is likely caused by a number of outside influences such as incorrect installation, wiring, dimming or transformers and in some instances low electrical resistance.

** Please contact sales@kaialighting.com for further information on dimmers etc. Please note KAIA Ltd cannot take any responsibility for the connection with your dimming or central control system. It is the customer's responsibility to ensure the compatibility with their systems.