

KAIA

LIA

INSTALLATION MANUAL

LIA

Suspension
Diagonal
100 / 50 / 30

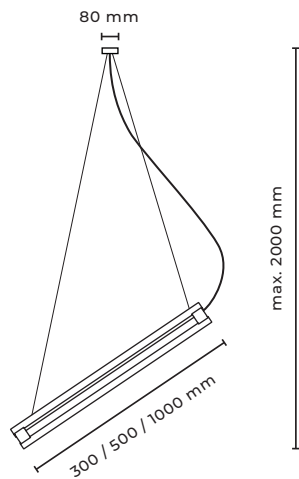

Type

Material

Environment

Dimension

Cable Length

Weight

Certification

EU/UK

Ceiling Rose

Lamps

100

50

30

Suspension light

Brass

Indoors

1000 / 500 / 300 x 125 mm

Standard mounting 1500mm

2.1 / 2.0 / 1,9 kg

IP20 CE

230 V

Ø 80 x 25 mm; flat Ø 100 mm

max 3x 120W, S14s,

max. 3 x 60 W, S14s,

max. 3 x 35 W, S14s,

CARE INSTRUCTIONS

* On very rare occasions, these lamps may appear to have a slight buzzing or flickering. As is the case with all retro LED lamps, this is likely caused by a number of outside influences such as incorrect installation, wiring, dimming or transformers and in some instances low electrical resistance.

** Please contact sales@kaialighting.com for further information on dimmers etc. Please note KAIA Ltd cannot take any responsibility for the connection with your dimming or central control system. It is the customer's responsibility to ensure the compatibility with their systems.

INSTALLATION

Before commencing installation ensure the relevant mains supply has been safely isolated/disconnected. Installation should be carried out by a qualified electrician. Ensure all electrical connections are tight with no loose strands, including factory made connections.

1. Fit the 3 lamps before starting the installation (see next page).
2. Connect the wire ropes to the rope holders on the lamp
3. Remove the base from the installation bracket.
4. Affix the bracket to the ceiling with 2 screws (hole size max. 4.5 mm, 50 mm apart).
5. Connect the unit to the mains.
6. Fix the unit back on its base and retighten 2 screws on the side.
7. Adjust the length of the wire ropes to the desired length. Please note that if the rope is cut it can no longer be extended.

STEP 1 SIDE VIEW

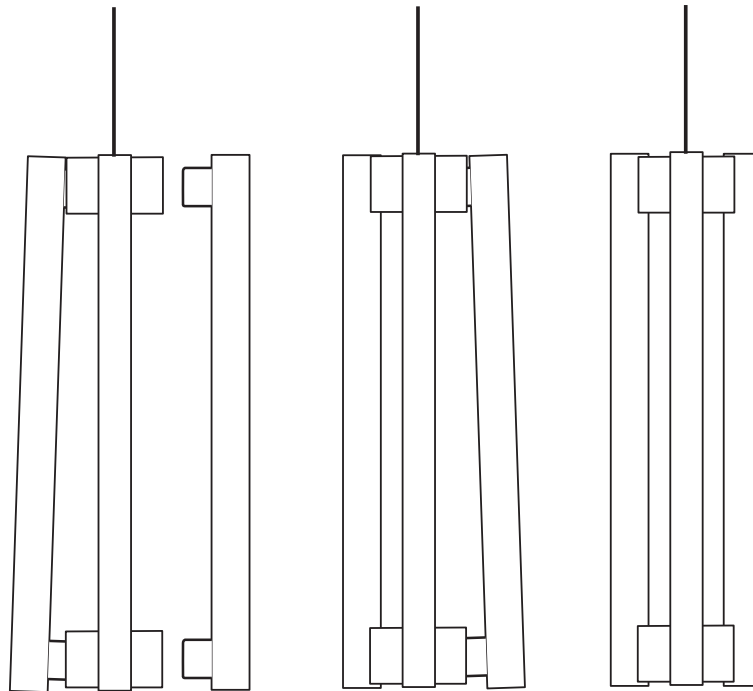

LAMP INSTALLATION

- Before commencing installation ensure the relevant mains supply has been switched off.
- Use supplied fabric gloves to prevent any stains on the surface of the lamp.
- Due to risk of glass fracture handle the lamp with care!
- Whilst applying pressure push the socket into the lamp holder in the marked place. Remove the lamp from the lamp holder carefully with both hands.

STEP 2

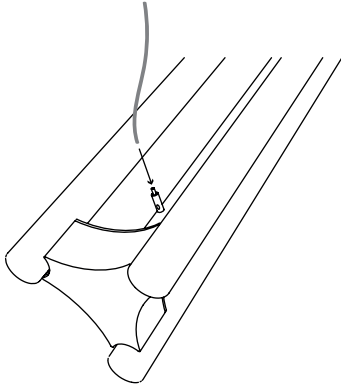

STEP 3 TOP VIEW

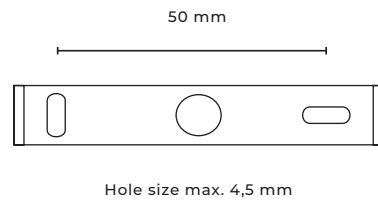

STEP 4 SIDE VIEW

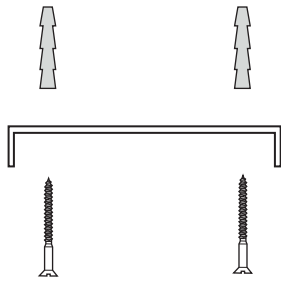

STEP 5 SIDE VIEW

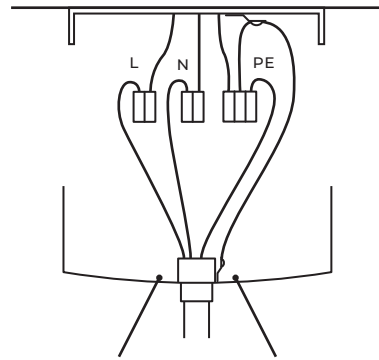

STEP 6 SIDE VIEW

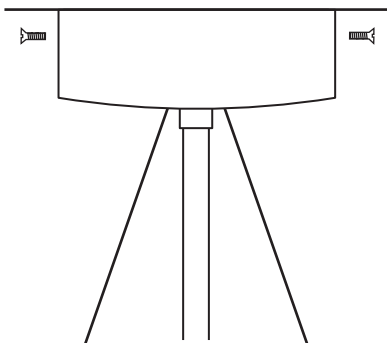

STEP 7

