

KAIA

INNER GLOW

INSTALLATION MANUAL

INNER GLOW

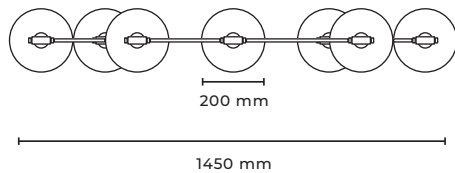
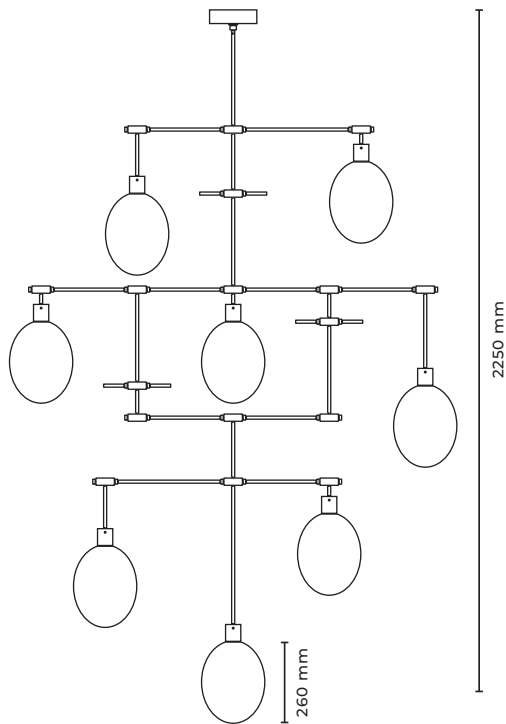

Type	Suspension light
Material	Solid brass/crystal glass/papier-mâché
Environment	Indoors
Dimensions	2250 x 200 x 1410 mm; Glass Ø 200 x 260 mm
Stem Length	300 mm (can be customized)
Weight	12 kg
Certification	IP20 CE
EU/UK	230 V
Ceiling Rose	Ø 150 mm x 45 mm
Lamping	8x LED Tube: E14 115mm Tube Light Bulb, clear, 2.7 W (250lm), 2600K, dimmable

* Please note the glass is mouth blown. The crystal glass might have some natural imperfections which are a result of the glass manufacturing process.

** Under unfavorable conditions these lamps can lead to acoustic noise. In case of resonance even low noise can cause audible effect. The installation as well as the dimmer or the transformer (harmonics or electronic resonance) are possible influencing factors.

*** Please contact sales@kaialighting.com for further information on dimmers etc. Please note KAIA Ltd cannot take any responsibility for the connection with your dimming or central control system. It is the customer's responsibility to ensure the compatibility with their systems.

INSTALLATION

Before commencing installation ensure the relevant mains supply has been safely isolated/disconnected . Installation should be carried out by a qualified electrician. Ensure all electrical connections are tight with no loose strands, including factory made connections. The Mains power must only be switched on once the fitting has been electrically connected.

GLOVES

You have chosen an oiled and waxed finish for your lighting fixtures, please make sure that these will only be touched with provided gloves and that the Care Instructions will be followed strictly.

STEP 1

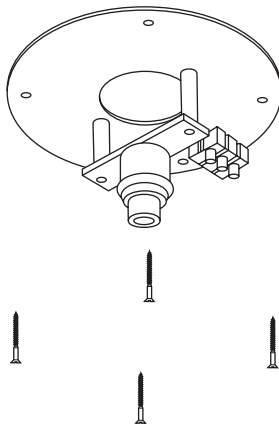

STEP 2

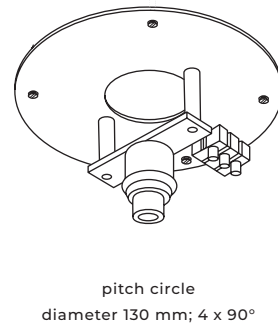

STEP 3

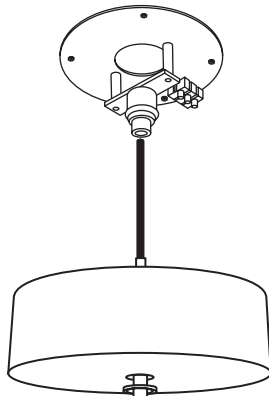

STEP 4

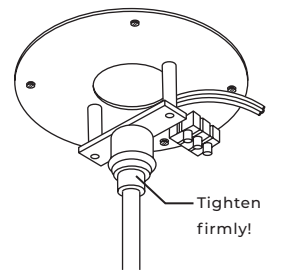

Please turn the upper screw until
it is tight! Do not turn the
lighting fixture itself

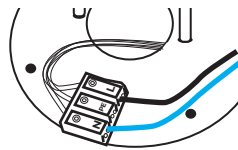

STEP 5

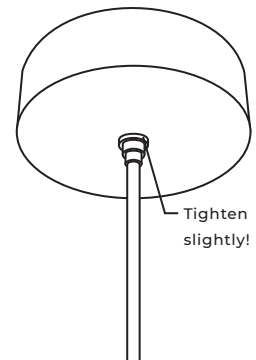

STEP 6.1

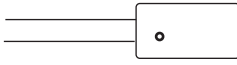

Adjust the adjustable screws to the glass ball opening. There has to be a minimum of 1 mm distance between the metal and the glass.

STEP 6.2

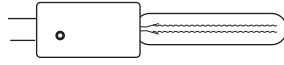

Screw in all bulbs, then switch on the circuit and test if the bulbs are functioning. With transportation the lampholders might get interfered and the bulb will not connect correctly. In this case please **disconnect the lighting fixture from the circuit**, bend the contact brackets slightly to ensure that the bulbs and the lampholder are connected.

STEP 6.3

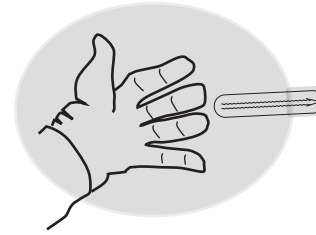

Carefully secure the glass sphere.

STEP 6.4

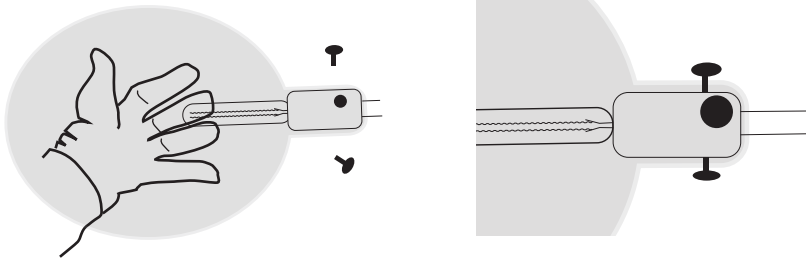

Carefully fix loosely with the supplied knurled-head screw by hand. Do not use a screw-driver. Do not screw too tightly, ensure there is at least 1 mm tolerance between the glass and the screw.

CARE INSTRUCTIONS

1. Use a soft dry cloth to ensure a fingerprint free surface. We recommend the use of micro fibre cloths.
2. Warning: do not use alcohol or other solvents for cleaning.

* Due to the manufacturing process differences in the finish between the different brass parts might accrue.

** Lighting fixtures designed for the indoor environment up to 24 ° C.

*** For destinations with Mediterranean climate we highly recommend a brushed and lacquered brass finish.