

K A I A

ETU

INSTALLATION MANUAL

ETU

Pendant
Luminaire

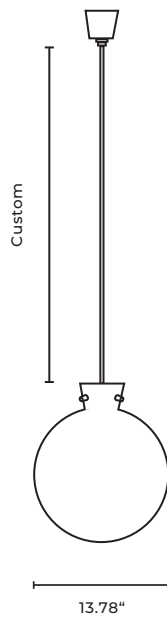

Type	Pendant
Material	Brass
Environment	Indoors
Dimensions	Glass Ø 13.78"
Stem Length	7.87/15.75/23.62" (can be customized)
Weight	13.23 lb
Ceiling Rose	Ø 3.15 x 2.56"
Certification	IP20 CE; ETL US/ CSA Canada
Lamping	Filament: E26, 110V, 8.86" Tube Light Bulb, clear, 40W, 2200 K, dimmable
Glass	Crystal clear, Ocean blue, Smokey grey *

* Please note the glass is mouth blown. The crystal glass might have some natural imperfections which are a result of the glass manufacturing process.

GLOVES

You have chosen an oiled and waxed finish for your lighting fixtures, please make sure that these will only be touched with provided gloves and that the Care Instructions will be followed strictly.

CARE INSTRUCTIONS

1. Use a soft dry cloth to ensure a fingerprint free surface. We recommend the use of micro fibre cloths.
2. Warning: do not use alcohol or other solvents for cleaning.
3. For destinations with Mediterranean climate we highly recommend a brushed and lacquered brass finish.

INSTALLATION

Before commencing installation ensure the relevant mains supply has been safely isolated/disconnected . Installation should be carried out by a qualified electrician. Ensure all electrical connections are tight with no loose strands, including factory made connections.

STEP 1

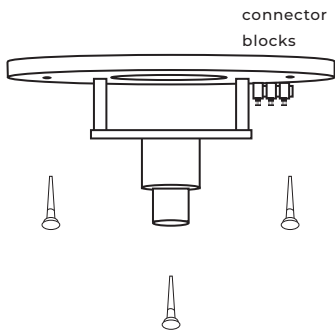

Fix the groundplate with screws to the ceiling.

STEP 2



Screw into the bulb.

STEP 3

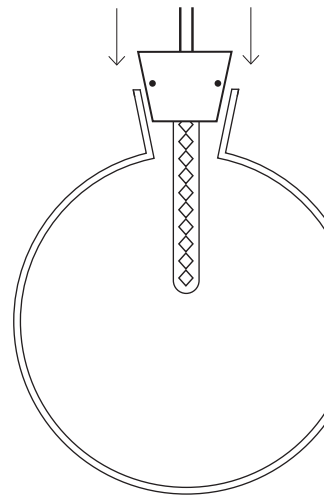

Carefully secure the metal cone into the glass sphere.

STEP 4

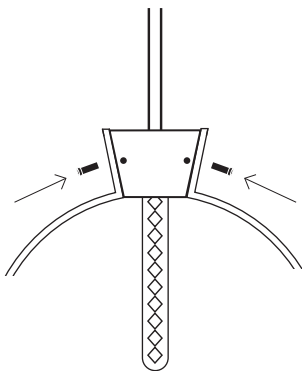

Fix loosely all the supplied screws by hand into position. Do not use a screwdriver.

STEP 5

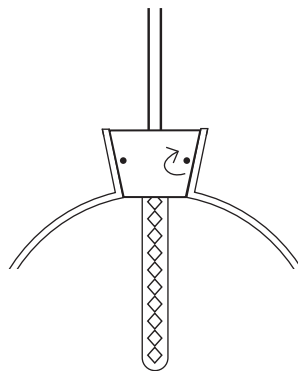

STEP 6

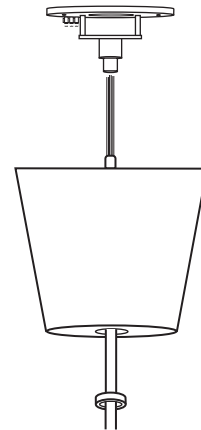

Put the stem through the ceiling rose.

STEP 7

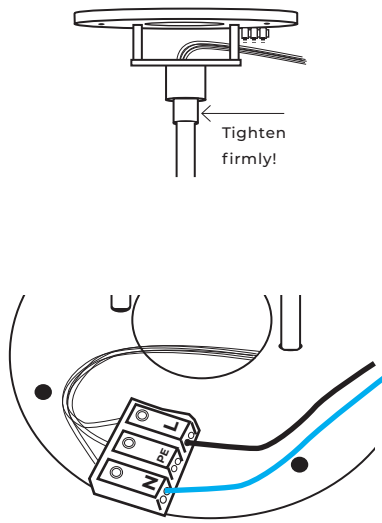

Thread the cables through the ball joint and screw the stem into the ball joint. After that connect the cable with the clamp on the groundplate.

STEP 8

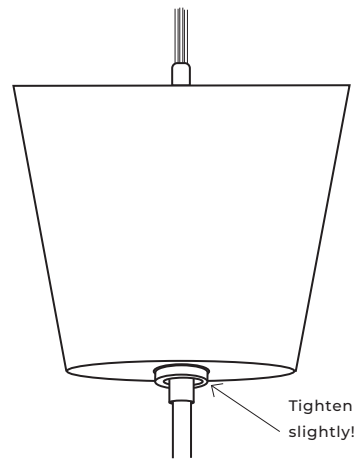

Lastly fix the ceiling rose with the knurled screw.