

Top

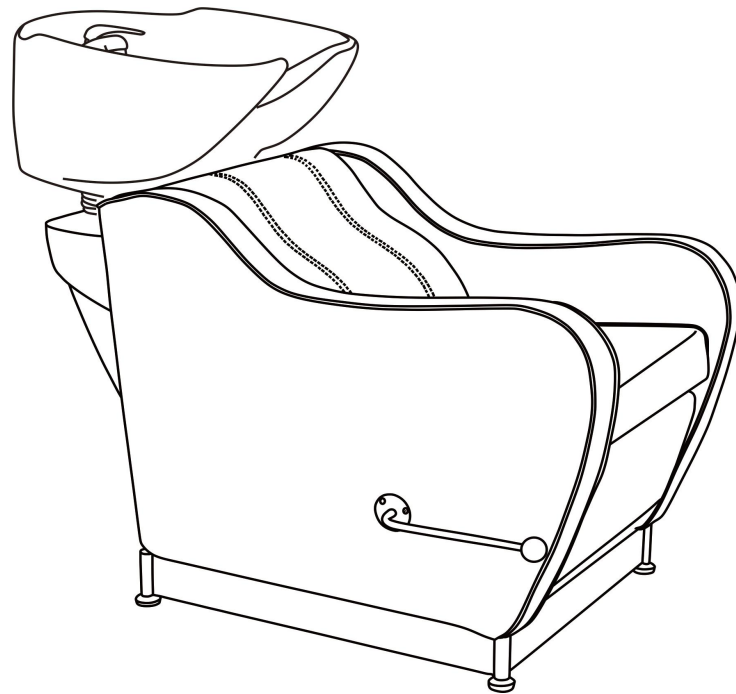

3019

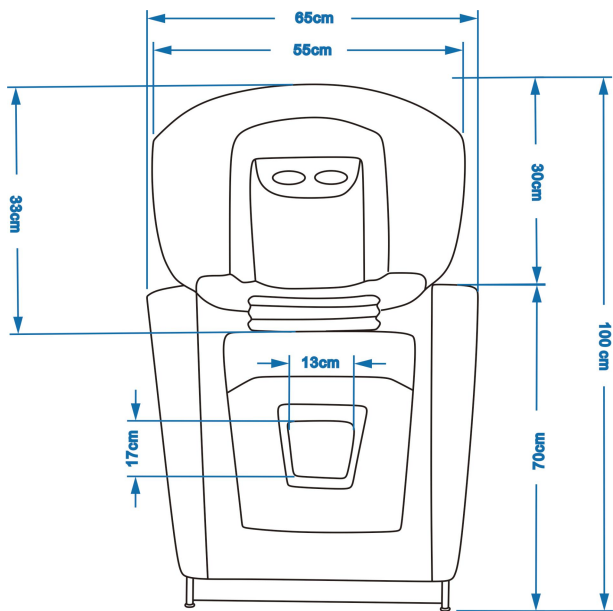

Back

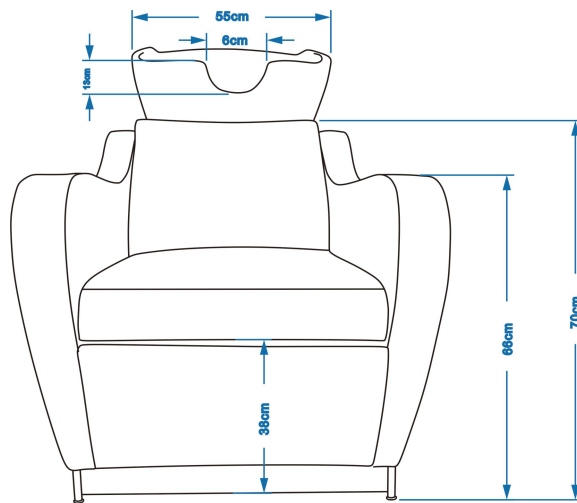

Front

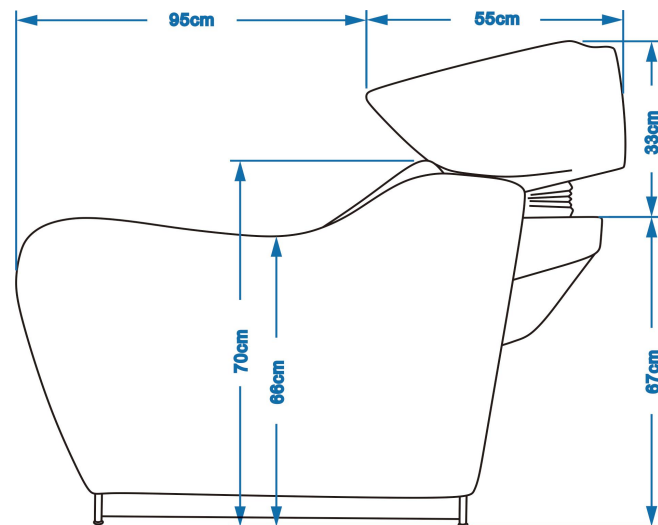

Right