

# LED Exterior Wall Sconce

# EW72355

INSTALLATION SHEET

## START FROM HERE

- Make sure **POWER** is **COMPLETELY OFF** at the fuse box
- Have your fixture installed by a qualified licensed electrician
- Prepare everything in a clear area
- Wear gloves at all time during this installation
- Read instructions carefully before you start assembly
- Keep this installation sheet for future reference

Technical Support: 1-855-855-8926

### Please Note:

- This Kuzco LED fixture comes with pre-wired LED module(s)
- Unless instructed, Do Not touch any part of the LED module(s) as any unnecessary contact with the module could cause permanent damage
- For dimming, an ELV (Electronic Low Voltage) type of dimmer is required
- 120V input

1. Remove fixture from its original package
2. Separate mounting plate (1c) from fixture (2a) by removing fixture screws (2b) and separate non-power mounting plate (3a) from fixture frame (3c)
3. Measure and mark location of non-power mounting plate (3a) location and secure to mounting surface with screws (3b) (See Illustration 2 for ideal distance measurements)
4. Attach mounting plate (1c) to electrical junction box (1a) using junction box screws provided (1e) in hardware package
5. Make proper electrical connections (black to hot "L", white to neutral "N", ground to "GND") with wire nuts (1b) provided in hardware package
6. Hook fixture frame (3c) onto non-power mounting plate (3a) and secure fixture (2a) to mounting plate (1c) with fixture screws (2b)
7. To prevent moisture from entering the electrical junction box (1a) and causing a short, seal around the top perimeter between the fixture and the wall surface with weather resistant caulking (Illustration 1)

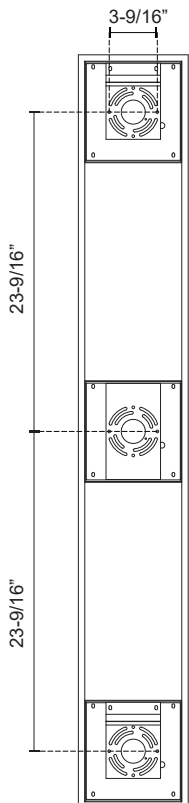
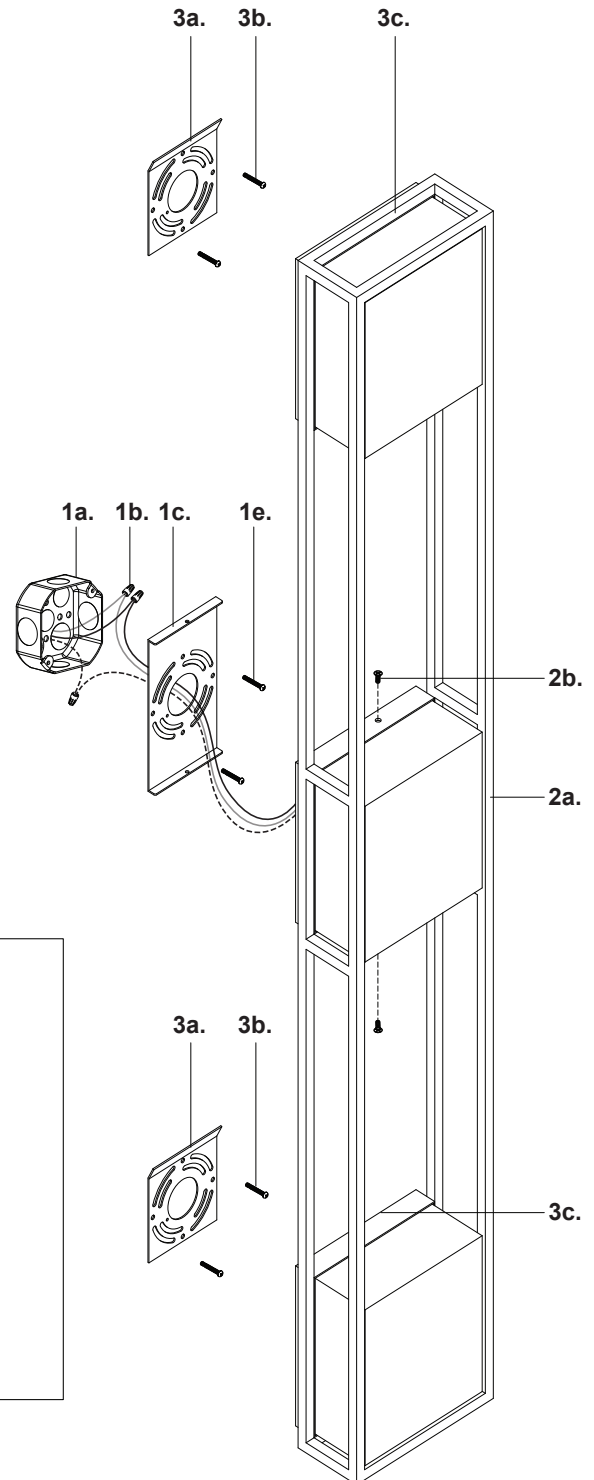
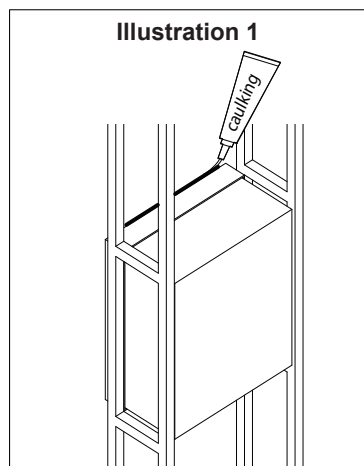

Illustration 2: Ideal distance of center of non-power mounting plate to center of mounting plate and ideal distance of anchor holes.



# KUZCO

19054 28th Avenue Surrey, BC Canada V3Z 6M3  
T: 604 538 7162 TF: 1-855 85 KUZCO F: 604 538 7196  
W: kuzcolighting.com  
20230109