

Benchtop Extraction Kits

Nederman Benchtop Extraction kits provide a quick and convenient solution for creating a fume-free workplace.

















The Benchtop extraction kits includes arm(s) with hood or nozzle, Fan with speed control and standard filter (particle, HEPA or gas), hose, connection details, and table bracket. The speed of the fan is variably controlled by a speed controller. Complete with hoses and extraction hoods. The hood is made of clear plastic, which increases the visibility.

Product name	Benchtop Extraction Kits
No of phases	1







Benchtop Extraction Kits

Image	Description	Power Voltage (V)	Frequency (Hz)	Electric plug	Weight (lbs)	Power (Hp)	Model
	EK1000 kit includes 2 x FX32, Max airflow 42 m³/h	220 - 240	50 / 60	Euro (CEE 7/2 P+E)	29	0.16 (0.12 Kw)	70508044
	EK1000 kit includes 2 x FX32, Max airflow 42 m³/h	110 - 120	50 / 60	US	29	0.16 (0.12 Kw)	70509344
	EK1000 kit includes 2 x FX32, Max airflow 42 m³/h	220 - 240	50 / 60	Without	29	0.16 (0.12 Kw)	70509544
	EK1500 kit includes 3 x FX32, Max airflow 38 m³/h	220 - 240	50 / 60	Euro (CEE 7/2 P+E)	33	0.16 (0.12 Kw)	70508144
	EK1500 kit includes 3 x FX32, Max airflow 38 m³/h	110 - 120	50 / 60	US	33	0.16 (0.12 Kw)	70509244
	EK1500 kit includes 3 x FX32, Max airflow 38 m³/h	220 - 240	50 / 60	Without	33	0.16 (0.12 Kw)	70509644
	EK2000 kit includes 1 x FX50, Max airflow 100 m³/h	220 - 240	50 / 60	Euro (CEE 7/2 P+E)	31	0.16 (0.12 Kw)	70507644
	EK2000 kit includes 1 x FX50, Max airflow 100 m³/h	110 - 120	50 / 60	US	31	0.16 (0.12 Kw)	70508844
	EK2500 kit includes 2 x FX50, Max airflow 75 m³/h	220 - 240	50 / 60	Euro (CEE 7/2 P+E)	37	0.16 (0.12 Kw)	70507744
	EK2500 kit includes 2 x FX50, Max airflow 75 m³/h	110 - 120	50 / 60	US	37	0.16 (0.12 Kw)	70508944
	EK3000 kit includes 1 x FX75, Max airflow 150 m³/h	220 - 240	50 / 60	Euro (CEE 7/2 P+E)	33	0.16 (0.12 Kw)	70507844
	EK3000 kit includes 1 x FX75, Max airflow 150 m³/h	110 - 120	50 / 60	US	33	0.16 (0.12 Kw)	70509044
	EK2000 kit includes 1 x FX50, Max airflow 100 m³/h	220 - 240	50 / 60	Without	31	0.16 (0.12 Kw)	70509444
	EK500 kit includes 1 x FX32, Max airflow 45 m³/h	110 - 120	50 / 60	US	24	0.16 (0.12 Kw)	70509144
	EK500 kit includes 1 x FX32, Max airflow 45 m³/h	220 - 240	50 / 60	Euro (CEE 7/2 P+E)	24	0.16 (0.12 Kw)	70507944

Benchtop Extraction Kits

Image	Description	Power Voltage (V)	Frequency (Hz)	Electric plug	Weight (lbs)	Power (Hp)	Model
	EK 2500 115V 2x FX 50 with All Carbon Filter	115v	60	US	33	0.16	86900225
	EK 1000 kit with All Carbon Filter	115v	60	US	33	0.16	86900189
	EK 3000 115V with All Carbon Filter	115v	60	US	33	0.16	86900185
	EK 2000 115V with All Carbon Filter						86900183

Benchttop Extraction Kits

	Accessory	Part No
	FX-Combi hood-ORIGINAL-D50/75/100	70500144
	FX-Dome hood-ORIGINAL-D50/75/100	70376982
	FX-Metal hood-ORIG/CHEM-D50/75/100	70500444
	FX-Flange hood-ORIGINAL-D50/75/100	70502844

Benchtop Extraction Kits

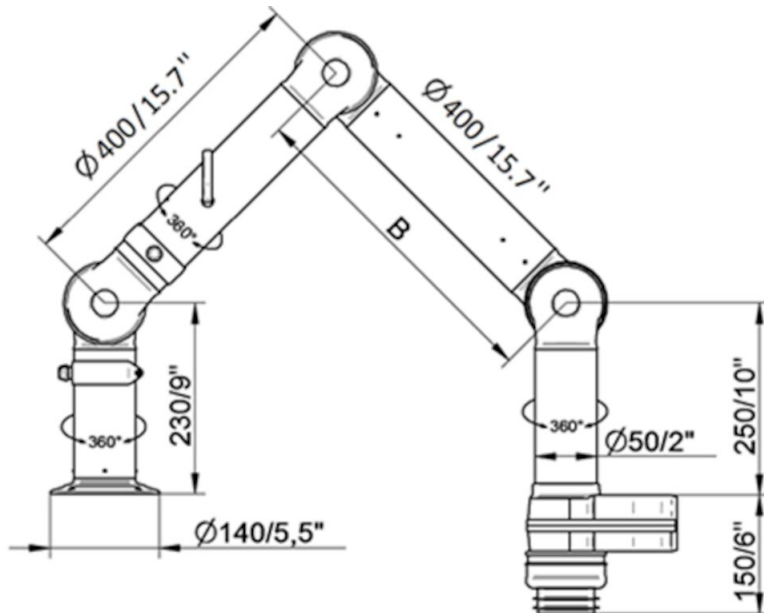

EK 2000

Arm(s): 1 x FX2 50 arm

Hood(s): 1 x combination hood

Hose: \varnothing 75 mm (3 inch), 3000 mm (118 inch) length

Max. airflow: 100 m³/h (58.8 cfm)

EK 2500

Arm(s): 2 x FX2 50 arm

Hood(s): 2 x mini hood

Hose: \varnothing 75 mm (3 inch), 3000 mm (118 inch) length

Max. airflow: 75 m³/h (44 cfm)

Benchtop Extraction Kits

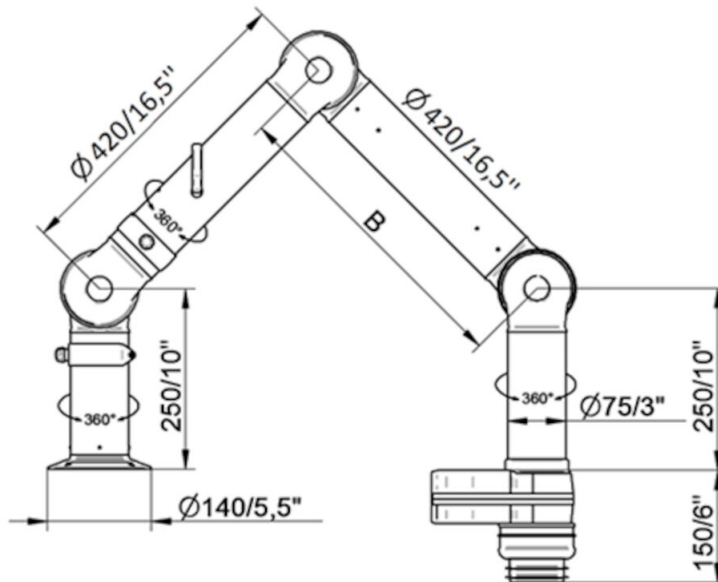

EK 3000
Arm(s): 1 x FX2 75 arm
Hood(s): 1 x mini hood
Hose: $\text{Ø}100$ mm (4 inch), 3000 mm (118 inch) length
Max. airflow: 150 m³/h (88.3 cfm)

Benchtop Extraction Kits

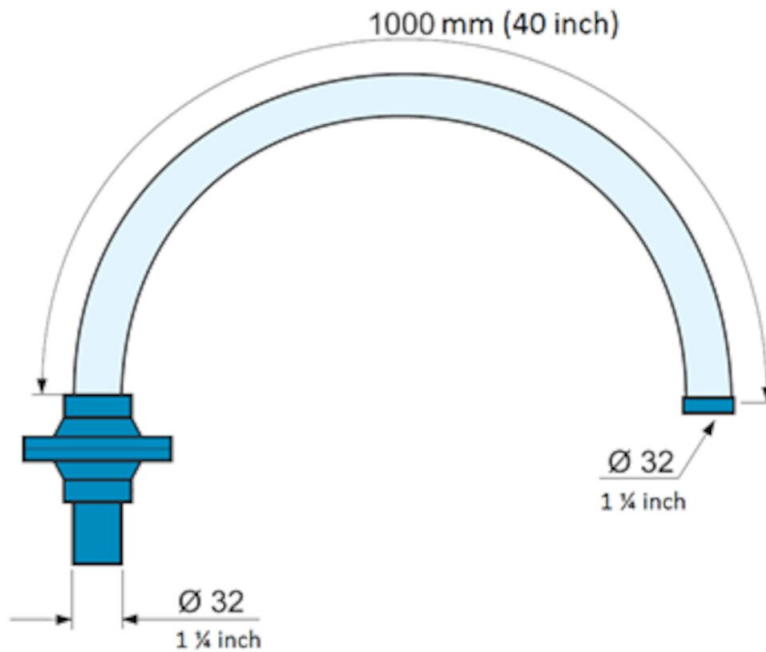

EK 500

Arm(s): 1 x FX 32 arm

Hood(s): 1 x dome hood ½

Hose: Ø 45 mm (1 ¼ inch), 3000 mm (118 inch) length

Max. airflow: 45 m³/h (26.5 cfm)

EK 1000

Arm(s): 2 x FX 32 arm

Hood(s): 2 x dome hood ½

Hose: Ø 45 mm (1 ¼ inch), 3000 mm (118 inch) length

Max. airflow: 42 m³/h (25 cfm)

EK 1500

Arm(s): 3 x FX 32 arm

Hood(s): 3 x dome hood 1/2

Hose: Ø 45 mm (1 ¼ inch), 3000 mm (118 inch) length

Max. airflow: 38 m³/h (22.4 cfm)