

Thank you for purchasing HAKKO FM-206 Rework System.
Please read this manual before operating the HAKKO FM-206.
Keep this manual readily accessible for reference.

1. PACKING LIST

Please check to make sure that all items listed below are included in the package.

HAKKO FM-206	1
Power cord	1
Tip tray	1
Instruction manual	1

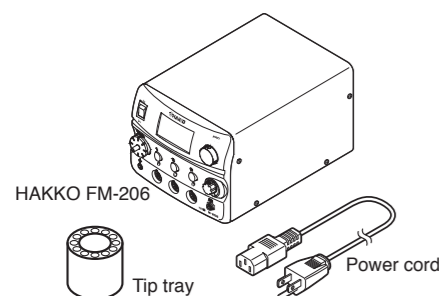

■ Use this product with the following models.

- HAKKO FM-2027 (Soldering Iron)
- MODEL FM-2022 (Parallel Remover)
- MODEL FM-2023 (Mini Parallel Remover)
- MODEL FM-2024 (Desoldering Tool)
- HAKKO FM-2026 (Soldering Iron N2 Type)
- HAKKO FM-2029 (Hot Air Handpiece)
- HAKKO FM-2030 (Heavy Duty Soldering Iron)
- HAKKO FM-2031 (Heavy Duty Soldering Iron N2 Type)
- HAKKO FM-2032 (Soldering Iron)

*Each Hakko handpiece with the exception of the HAKKO FM-2027 has their own instruction manual. Please refer to this manual for specifications and replacement parts.

2. SPECIFICATIONS

Power Consumption	MAX 410W (450W)
Temperature Range	HAKKO FM-2026/2027/2032 200 - 450°C (400 - 840°F) MODEL FM-2022/2023 200 - 400°C (400 - 750°F) MODEL FM-2024 350 - 450°C (660 - 840°F) HAKKO FM-2029 100 - 550°C (200 - 1030°F) HAKKO FM-2030/2031 200 - 500°C (400 - 930°F)
Temperature Stability	±5°C (±9°F) at idle temperature

● Station	
Output	24V
Dimensions (W x H x D)	162 x 136 x 245 mm (6.4 x 5.4 x 9.7 in.)
Weight	6.2 kg (13.7 lb.)
Capacity (Max)	6L/min.
Vacuum Generator	Vacuum pump, cylinder type
Vacuum Pressure (Max.)	80kpa (600 mm Hg) (24 in. Hg)
Suction Flow	14L/min.

● HAKKO FM-2027	
Power Consumption	70 W (24 V)
Tip to Ground Resistance	< 2 Ω
Tip to Ground Potential	< 2 mV
Cord	1.2 m (4 ft)
Total Length (w/o cord)	188 mm (7.4 in.) with 2.4D tip
Weight (w/o cord)	30 g (0.067 lb./1.07 oz.) with 2.4D tip

CAUTION
Power consumption is different depending on Standards.

- * The temperature was measured using the HAKKO FG-101 thermometer.
- * This product is protected against electrostatic discharge.
- * Specifications and design are subject to change without notice.

Electrostatic Protection

This product includes such features as electrically conductive plastic parts and grounding of the handpiece and station as measures to protect the device to be soldered from the effects of static electricity. Be sure to observe the following instructions:

1. The handle and other plastic parts are not insulators, they are conductors. When making repairs or replacing parts, take sufficient care not to expose live electrical parts or damage insulation materials.
2. Be sure to ground the unit during use.

※各言語（日本語、英語、中国語、フランス語、ドイツ語、韓国語）の取扱説明書は以下のURL、HAKKO Document Portalからダウンロードしてご覧いただけます。
（商品によっては設定の無い言語がありますが、ご了承ください。）
*各言語書（日本語、英語、中文、法語、ドイツ語、韓国語）の使用説明書は通過以下网站的HAKKO Document Portal 下载参阅。
（有一部分的產品沒有設定外語對應，請見諒）
* Instruction manual in the language of Japanese, English, Chinese, French, German, and Korean can be downloaded from the HAKKO Document Portal.
(Please note that some languages may not be available depending on the product.)
➡ <https://doc.hakko.com>

HAKKO CORPORATION

HEAD OFFICE
4-5, Shiokusa 2-chome, Naniwa-ku, Osaka 556-0024 JAPAN
TEL: +81-6-6561-3225 FAX: +81-6-6561-8466
<https://www.hakko.com> E-mail: sales@hakko.com

OVERSEAS AFFILIATES
U.S.A.: AMERICAN HAKKO PRODUCTS, INC.
TEL: (661) 294-0090 FAX: (661) 294-0096
Toll Free (800) 88-HAKKO
<https://www.HakkoUSA.com> E-mail: Support@HakkoUSA.com

HONG KONG: HAKKO DEVELOPMENT CO., LTD.
TEL: 2811-5588 FAX: 2590-0217
<https://www.hakko.com.cn> E-mail: info@hakko.com.hk

SINGAPORE: HAKKO PRODUCTS PTE., LTD.
TEL: 6748-2277 FAX: 6744-0033
<https://www.hakko.com.sg> E-mail: sales@hakko.com.sg

Please access the web address below for other distributors.
<https://www.hakko.com>

3. WARNINGS, CAUTIONS, NOTES AND EXAMPLES

Warnings, cautions and notes are placed at critical points in this manual to direct the operator's attention to significant items. They are defined as follows:

WARNING: Failure to comply with a WARNING may result in serious injury or death.

CAUTION: Failure to comply with a CAUTION may result in injury to the operator, or damage to the items involved.

NOTE: A NOTE indicates a procedure or point that is important to the process being described.

CAUTION

When power is ON, the tip will be hot. To avoid injury or damage to personnel and items in the work area, observe the following:

- Do not touch the tip or the metal parts near the tip.
- Do not allow the tip to come close to, or touch, flammable materials.
- Inform others in the area that the unit is hot and should not be touched.
- Turn the power off when not in use, or left unattended.
- Turn the power off when connecting the handpieces or storing the HAKKO FM-206.
- This appliance is not intended for use by persons (including children) with reduced physical, sensory or mental capabilities, or lack of experience and knowledge, unless they have been given supervision or instruction concerning use of the appliance by a person responsible for their safety.
- Children should be supervised to ensure that they do not play with the appliance.

4. INITIAL SETUP

Part Names

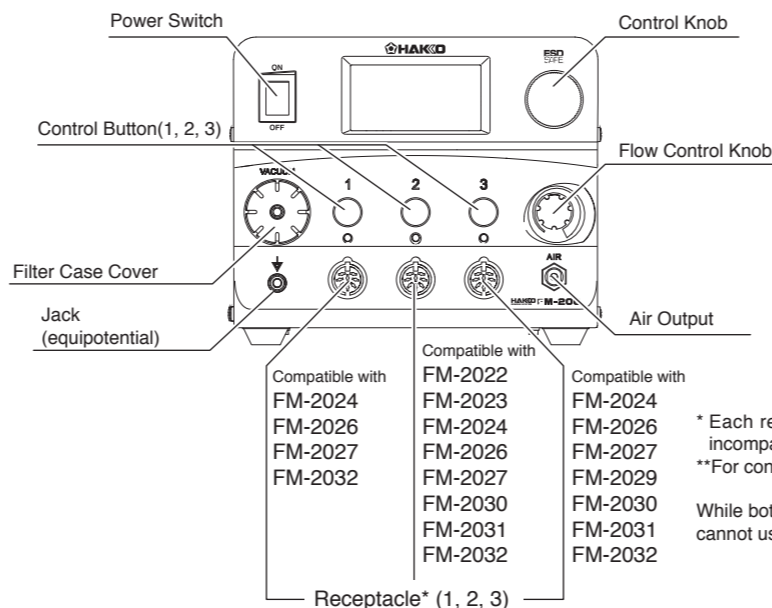

- Compatible with FM-2024, FM-2026, FM-2027, FM-2032
- Compatible with FM-2022, FM-2023, FM-2024, FM-2026, FM-2027, FM-2029, FM-2030, FM-2031, FM-2032
- Compatible with FM-2024, FM-2026, FM-2027, FM-2029, FM-2030, FM-2031, FM-2032

Setup

Hooking up the iron and connecting cable.

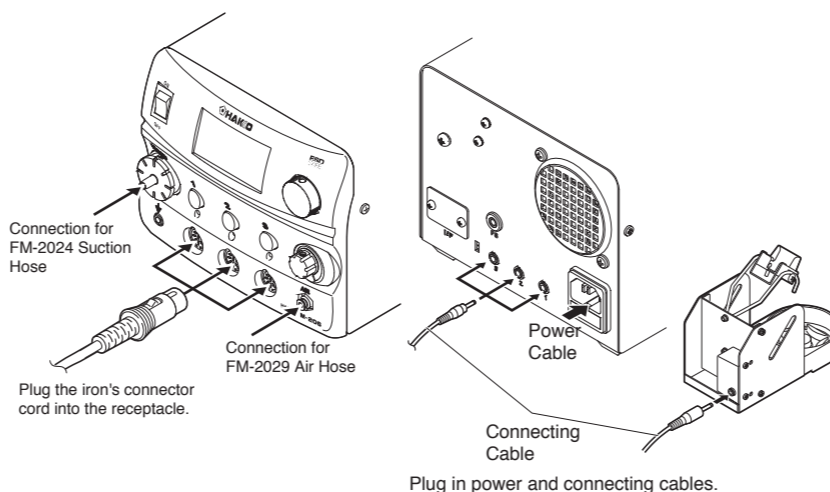

CAUTION

- Please make sure the power is off when you plug in cables.
- Please make sure to hook up the connector cable and the iron holder on the same channel and not to place the iron in a holder connected to a differing channel.
- Please take care not to mix up the hose connections, the MODEL FM-2024 connects to the filter case cover and the HAKKO FM-2029 to the air output.
- Securely insert the connecting cable all the way in to the jack.

To prevent accidents or damage to the HAKKO FM-206, be sure to observe the following:

- Do not use the HAKKO FM-206 for applications other than soldering.
- Do not strike the iron against hard objects to remove excess solder. This will damage the iron.
- Do not modify the HAKKO FM-206.
- Use only genuine Hakko replacement parts.
- Do not allow the HAKKO FM-206 to become wet, or use it with wet hands.
- Remove power and iron cords by holding the plug – not the wires.
- Be sure the work area is well ventilated. Soldering produces smoke.
- While using HAKKO FM-206, don't do anything which may cause bodily harm or physical damage.

Switch, Control Button and Knob Usage

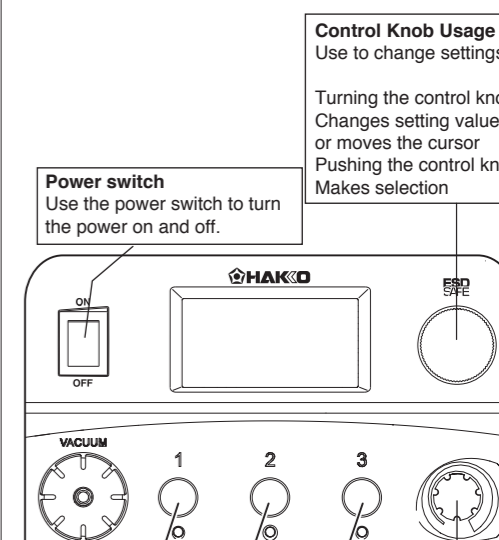

Power switch
Use the power switch to turn the power on and off.

Control Knob Usage
Use to change settings
Turning the control knob:
Changes setting values or moves the cursor
Pushing the control knob:
Makes selection

Replacing the tip (HAKKO FM-2027)

CAUTION

The tip may be hot. Avoid holding the hot tip for a long time even if using the heat-resistant pad. Otherwise burns may result.

Removing the tip:

- Hold down the lock release buttons in the sleeve assembly, pull out the tip together with the sleeve assembly from the connector.

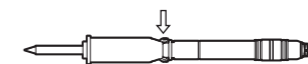

CAUTION

- Be sure to keep the lock release buttons held down while pulling out the sleeve assembly. Failure to do so will damage the locking mechanism.
- Be sure to pull out the tip only after separating the sleeve assembly from the connector. Otherwise, the sleeve assembly may fall down and break.

- While holding the front end of the sleeve assembly, pull out the tip.

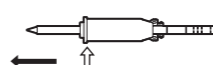

Insert the tip:

- Reassemble in the reverse order of disassembly.

CAUTION

- Insert the tip into the sleeve assembly until it clicks into place. When you hear it click, avoid forcing the tip into the sleeve assembly.
- When holding the head of the tip, there is a danger of burn. Be sure to use the heat-resistant pad.

*Each Hakko handpiece with the exception of the HAKKO FM-2027 has their own instruction manual. Please refer to this manual for specifications and replacement parts.

Control Buttons

Use to change settings such as temperature.

When pressed briefly:
Displays the preset screen.
When pressed and held:
Displays the change settings screen.

- Change Settings Screen Details
1. Temperature Settings
 2. Offset Settings
 3. Preset Temperature Settings
 4. Preset Names
 5. Channel Power (On/Off)
 - 6 Exit

Flow Control Knob

When HAKKO FM-2029 is connected to HAKKO FM-206, air flow will be displayed. By turning the flow control knob, air flow can be changed.

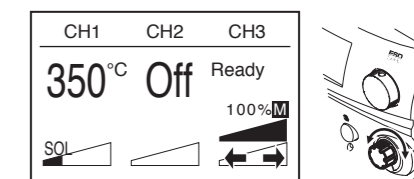

* If you press a control button while on the Preset or Change Settings screen, the corresponding channel screen will be displayed.

Plugged in irons will be heated according to the settings when the power is turned on.

5. OPERATION

- Various setting changes (Preset select)
- Range of preset temperatures

Initial preset temperatures for each grip

Grip	Initial Value
HAKKO FM-2027 / FM-2026 / FM-2032	300/350/400°C (570/660/750°F)
MODEL FM-2022 / FM-2023	300/350/400°C (570/660/750°F)
MODEL FM-2024	350/375/400°C (660/700/750°F)
HAKKO FM-2030 / FM-2031	300/350/400°C (570/660/750°F)
HAKKO FM-2029	300/350/400°C (570/660/750°F)

* When the acceptable setting range is exceeded it will return to the initial setting.
(For the setting range, refer to "Initial preset temperatures for each grip.")

**The setting temperature, offset temperature, preset temperature, and preset name are remembered by each grip.

- Selecting the Preset Temperature

1. Press the control button for the channel you want to change.

The display screen will switch to the preset selection screen shown below.

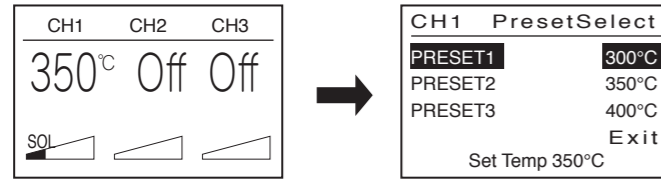

2. By turning the control knob, the preset temperature to be selected will change.

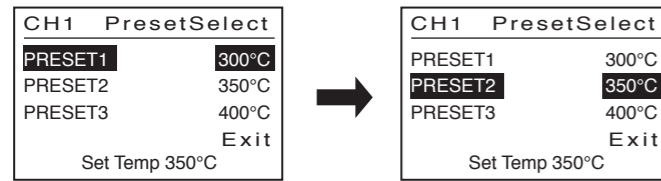

3. Press the control knob when the desired preset temperature is highlighted.

The iron tip will now be set to the selected preset temperature.

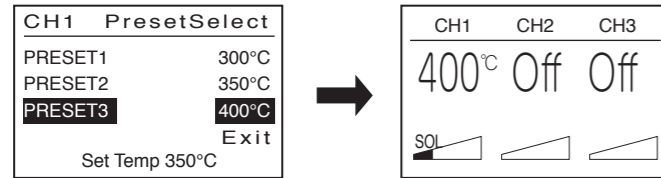

* Should you press another control button while in the preset selection screen, it will shift to that channel's preset selection screen if the channel is in operation, and it will return to the screen before the preset selection screen if the channel is not in operation.

- Changing various settings (other than preset selections)

- Setting items, possible change range and initial value

Items that can be changed during normal operation and initial setting

	Possible Change Range	Initial Value
Set Temp	Refer to "Temperature ranges for each grip."	350°C (750°F)
Offset Temp	+/- 50°C (+/- 90°F)	0°C (0°F)
Preset Temp	Refer to "Temperature ranges for each grip."	(Varies by grip)
Preset ID	Input up to 7 characters (English numerals + '_').	PRESET1 / PRESET2 / PRESET3
CH Power	ON / OFF	ON

*For setting items pertaining to the HAKKO FM-2029 Hot Air Pencil, please refer to "Settings for the HAKKO FM-2029 Hot Air Pencil" later in this manual.

Temperature range for each grip

Grip	Setting Temperature Range
HAKKO FM-2027 / FM-2026 / FM-2032	200~450°C (400~840°F)
MODEL FM-2022 / FM-2023	200~400°C (400~750°F)
HAKKO FM-2024	350~450°C (660~840°F)
HAKKO FM-2030 / FM-2031	200~500°C (400~930°F)
HAKKO FM-2029	100~550°C (200~1030°F)

- Change procedures (initial and when finished)

1. Press and hold the control button for the channel you want to change for approximately 1 second.
The display screen will switch to the setting selection screen shown below.

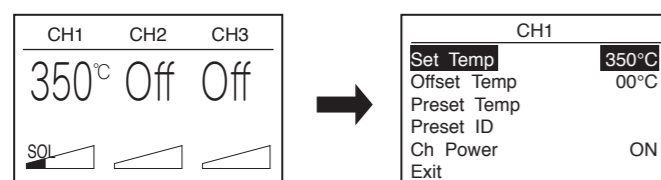

2. Select the item you want to change in the screen above by turning the control knob to highlight the item, and press the control knob to change the setting. When you are finished, turn the control knob to select EXIT and press the control knob.

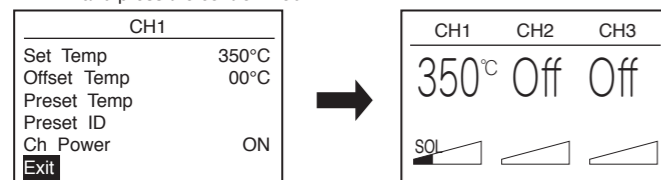

- Change setting temperature and offset temperature

1. Turn the control knob and highlight SET TEMP for the setting temperature or OFFSET TEMP for the offset temperature, and press the control knob to change the setting.

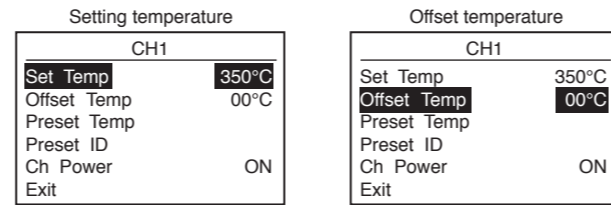

2. SET TEMP will begin adjusting from the highest possible setting digit; OFFSET TEMP will start with either a blank space, representing a positive (+) value, or a '-' for a negative value.

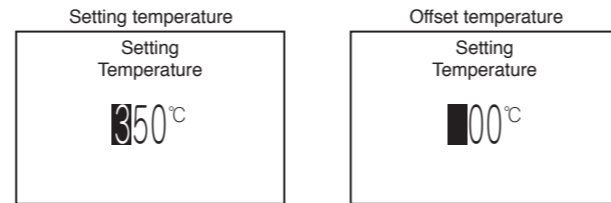

For the third digit of the offset temperature, select either + (blank) or -.

3. Turn the control knob to change the value of the selected digit, and press the control knob to accept the value and move to the next digit. (The figure below is an example using the SETTING TEMPERATURE display.)

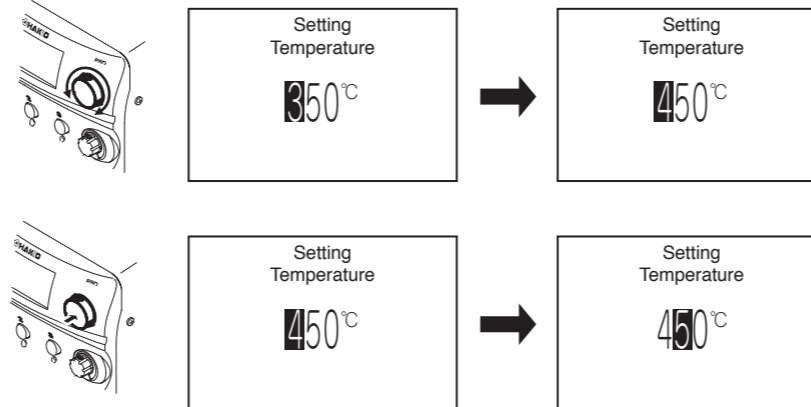

4. After the last digit has been accepted by pressing the control knob, the screen will return to the previous menu.

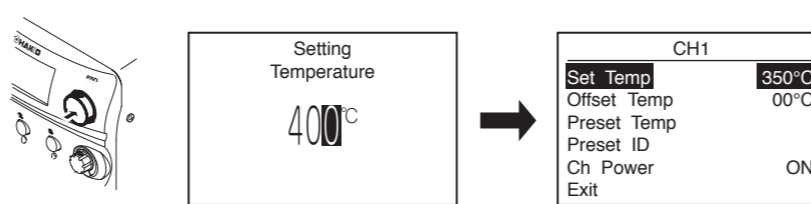

- Setting the preset temperature

1. Turn the control knob, select "Preset Temp," and press the control knob when you have made your choice.

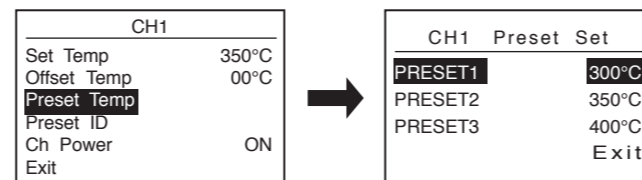

2. Turn the control knob, and make your choice by selecting the desired preset from the three options shown and pressing the control knob.

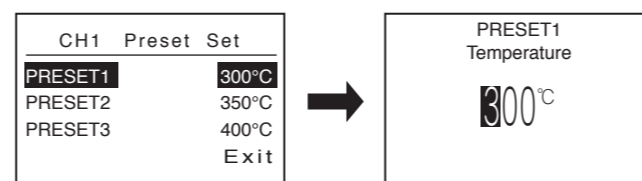

Changing the value for each selected preset follows the same steps as when changing the SET TEMP.

- Changing the preset ID

1. When you select the preset ID and press the operating knob, it will move to a screen where you can change the names of each preset.

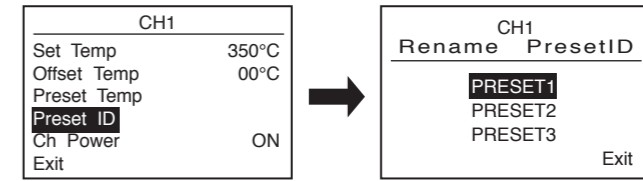

2. When you highlight the PRESET NAME you want to change, press the control knob.

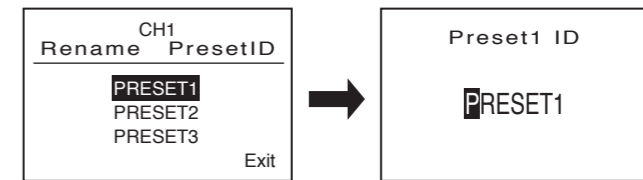

3. Turn the control knob to change the highlighted character in the PRESET NAME, and press the control knob to accept the value and move to the next character.

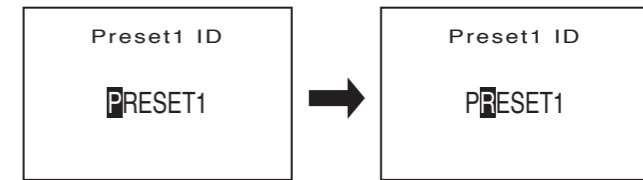
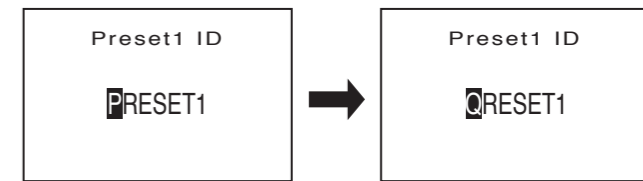

4. Once you accept the value for the last character, the menu returns to the PRESENT ID list.

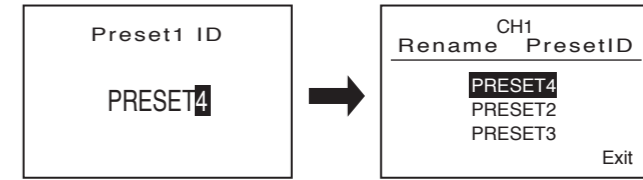

- Switching the ON/OFF output for each channel

1. Turn the control knob so that the cursor is on "Ch Power" and press the control knob.

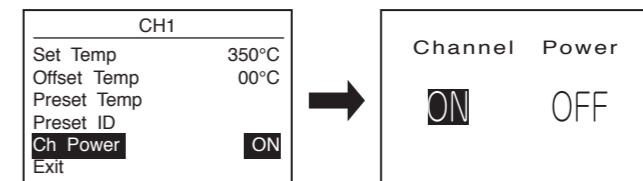

2. When you select either ON or OFF for the CHANNEL POWER and press the control knob, it will return to the setting screen. At this time, if you set the power to OFF, the setting screen will be as shown below. This is because settings other than the channel power are no longer necessary.

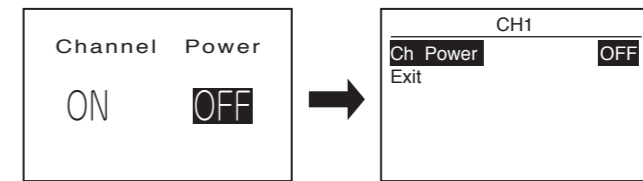

5. OPERATION

● Settings for the HAKKO FM-2029 Hot Air Pencil

The Hot Air Pencil can only be used on CH3. When you connect it, the screen will be as shown below.

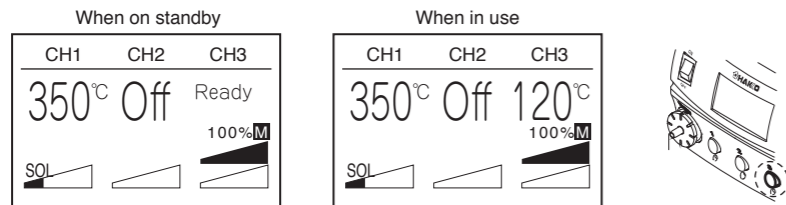

The Hot Air Pencil has a manual mode and an auto mode, and the settings that can be changed are different.

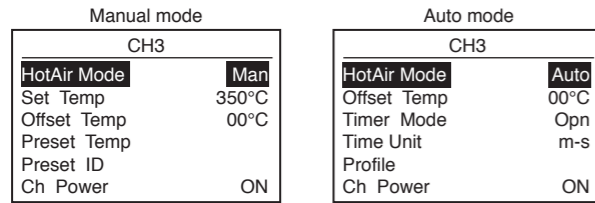

In either case, the screen is set to scroll since all of the items cannot fit on the screen. In manual mode, other than selecting Hot Air Mode, both the changing method and initial settings are the same as the other grips.

● Initial settings when in auto mode

	Initial Value
Offset Temp	0°C (0°F)
Timer Mode	Opened
Time Unit	min-sec
Profile (Temp) (Time)	300/350/400°C (570/660/750°F) 30/30/30sec
Ch Power	ON

The steps for changing settings with the same name are the same as the setting method for the other grips. The steps for changing settings not previously covered are illustrated below.

● Changing Timer Mode

1. Turn the control knob, select "Timer Mode," and press the control knob when you have made your choice.

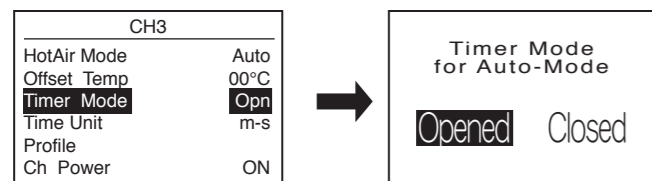

2. When you have selected the desired setting, press the control knob.

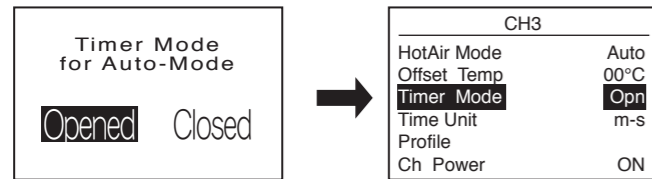

■ On the difference between Opened and Closed in "Timer Mode"

In Auto mode, the temperature profile shown below is followed by the system. In OPENED timer mode, the time for each step starts the countdown once the output air temperature reaches the set value. In CLOSED timer mode, the timer starts immediately regardless if the output air temperature has reached the set value or not.

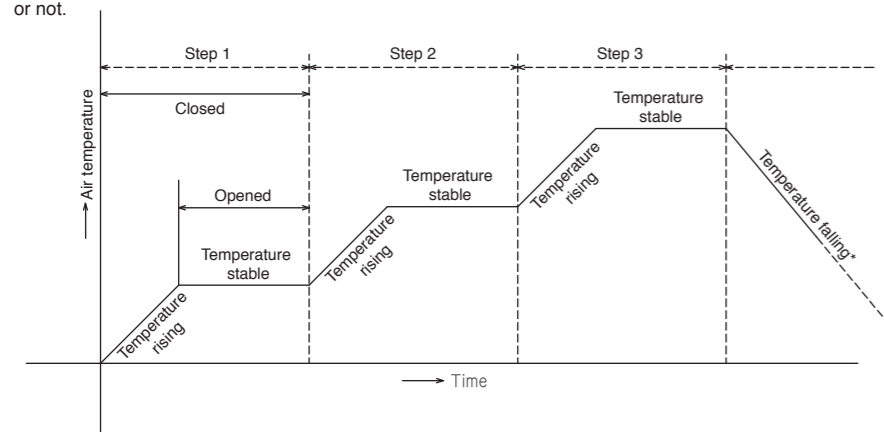

*In Auto mode, a 15 second cool-down will be performed after all steps are completed and the air will stop.

● Changing Time Unit

1. Turn the control knob and select "Time Unit." Press the control knob.

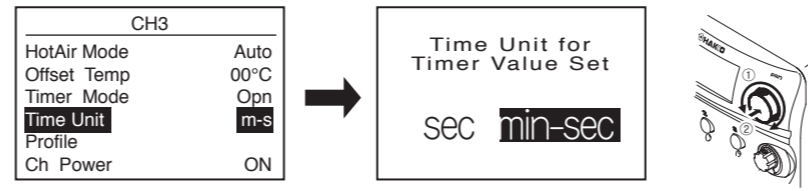

2. When you press the control knob after making your selection, it will return to the setting selection screen.

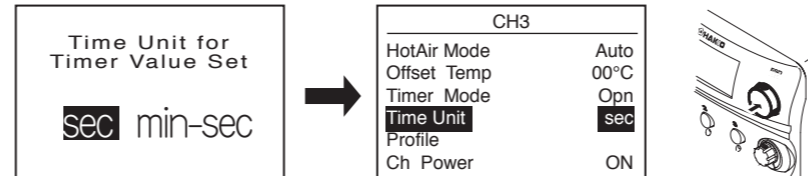

For the Time Unit, when you set the temperature profile, the set time for each step will be displayed as "sec" for seconds and "min-sec" for minutes and seconds.

● Changing the Profile

1. Turn the control knob and select "Profile." When you press the control knob, it will switch to the profile setting screen.

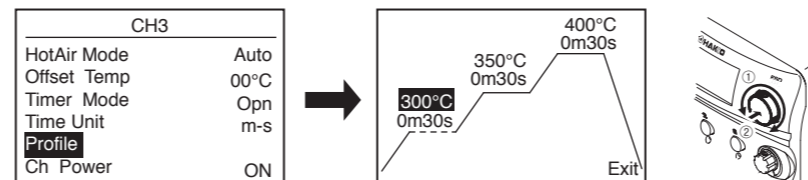

2. When you press the control knob once in the profile setting screen, you can change the value of the profile parameter highlighted.

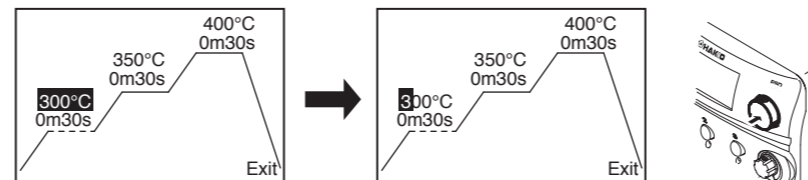

3. To change the parameter value, turn the control knob to highlight the value you want to change, and press the control knob start the change.

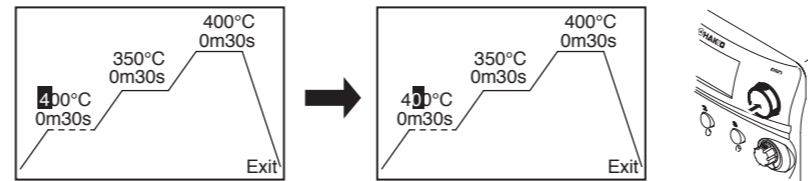
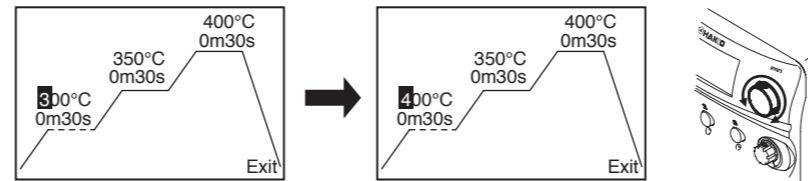

4. When you press the control knob after changing the last digit highlighted in the parameter, the screen will return to the original profile setting screen.

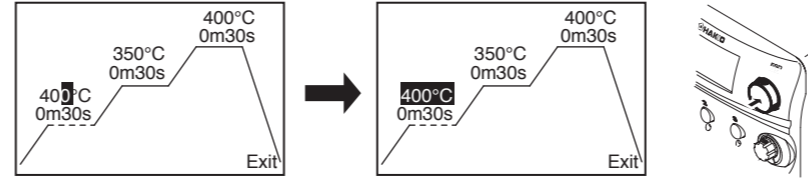

* To move to another profile parameter make another change, turn the control knob to highlight the parameter.

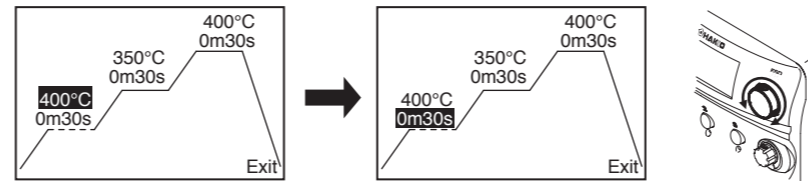

6. PARAMETER SETTINGS

■ Parameter settings

For parameters, there are two types: system parameters and channel parameters. System parameters are used for the settings for the entire system, and channel parameters are used for the settings for each channel. The change parameters screen can be displayed by turning on the power while the control knob is pressed.

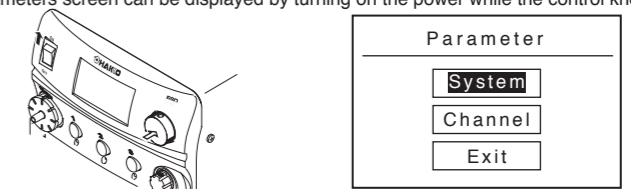

System parameters		
Parameter name	Value	Initial value
Temp Mode	°C / °F	°C
Auto-Shut Off	Off / 30min / 60min	Off
Vacuum Mode	Normal / Timer	Normal
Vacuum Time*	1~5sec	1sec
Password Lock	ON / Partial / OFF	OFF
Password**	3 upper case alphabetic characters	none
Initial Reset	OK / Cancel	

System setting screen		
System		
Temp Mode	°C	
ShutOff Set	Off	
Vacuum Mode	Norm	
Password Lock	Off	
InitialReset		
Exit		

* "Vacuum Time" is displayed when "Timer" is selected in Vacuum Mode.
** "Password" is displayed when "ON" or "Partial" is selected for the Password Lock.

Channel parameters		
Parameter name	Value	Initial value
AutoSleep	OFF / 0 ~ 29min	6min
Sleep Temp	200 ~ 300°C increments of 20°C (390 ~ 570°F increments of 36°F)	200°C (390°F)
Low Temp	30 ~ 150°C (54 ~ 270°F)	150°C (270°F)
Error Alarm	On / Off	On
Ready Alarm	On / Off	On
Pump Select*	Internal / External	Internal
Exit		

* "Pump Select" is displayed when a hot air handpiece is connected to channel 3.

Explanation of each parameter and how to change the settings

● Temperature Mode

The displayed temperature can be switched between Centigrade and Fahrenheit. Turn the control knob to switch it and press the control knob when you have made your choice.

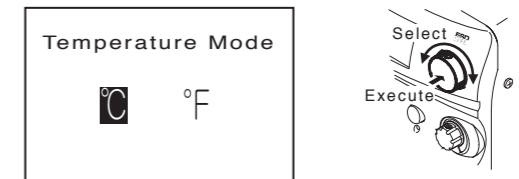

● Auto-Shut Off Setting

Select whether you will activate the auto shut off function. You can select from three options: OFF, 30 minutes or 60 minutes. Turn the control knob when making your selection and press the control knob when you have made your choice.



● Vacuum Mode Setting

Suction with the desoldering iron is performed either manually or in timer form. For mode selection, turn the control knob and press the control knob when you have made your choice.

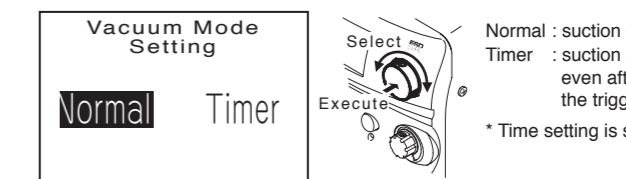

Normal : suction only when the trigger is pulled
Timer : suction performed for a designated time* even after you remove your hand from the trigger

* Time setting is set as "Vacuum Time".

● Vacuum Time

This item is displayed when selecting "Timer" in Vacuum Mode. After suction, you can set the amount of time it will operate after you remove your hand from the trigger. When changing the numerical value, turn the control knob; Press the control knob to accept your selected value.



6. PARAMETER SETTINGS

● Password Lock Setting

When this function is activated, settings cannot be changed if the correct password is not entered. Selection choices are as follows.

- ON : Password entry required when changing all settings
- Partial : Password entry not required only when setting the offset, but required for everything else
- OFF : Password entry not required when changing all settings

Turn the control knob and highlight the desired item, then press the control knob when you have made your choice. When the password lock is set to "ON" or "Partial," the item "Password" will be added to the parameter settings. Here, password changes can be performed.

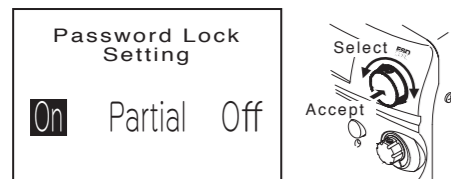

A password is not included when it is shipped from the factory. Immediately after the password lock is activated, it will move to the password input screen.

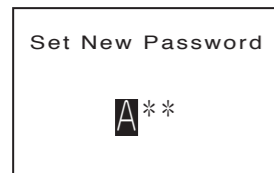

Please refer to the "Password" section for how to enter your password.

After activating the password lock, you will be asked for your password before changing your settings in the manner shown below, so please change your settings after entering your password.

Example: When setting the Vacuum Mode

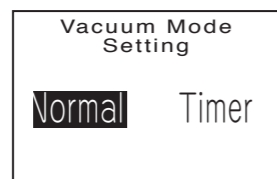
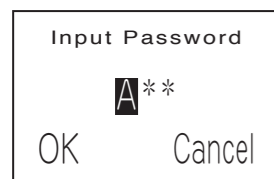

● Password

This is displayed when the password lock is activated, and you can enter and change your password. However, as stated above, entering your password is necessary before almost all setting changes. This is also true when you change your password, and when the first password input screen will be displayed.

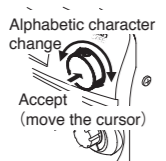
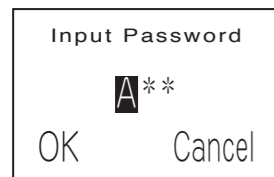

When changing the alphabetic characters, turn the control knob, and when moving the cursor to the next character, press the control knob.

When you enter the correct password, the monitor title will change from "Input Password" to "Set New Password". If it is still on "Input Password," the correct password was not entered. Check your password once more and then enter it.

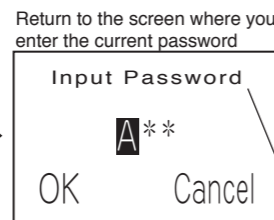
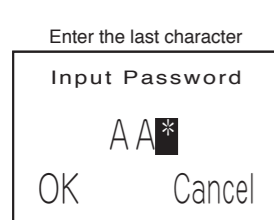

Input failure

Successfully entered

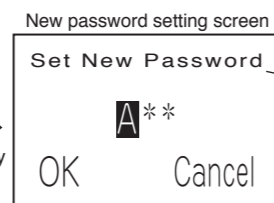

In the event you completely forgot your password and cannot change your settings, please contact your HAKKO representative

Here is how you know you are on the right page.

● Initial Reset

With initial reset, you can return the settings (except for the password) to what they were when it was shipped from the factory. The selection and execution methods are the same as the methods for the other settings.

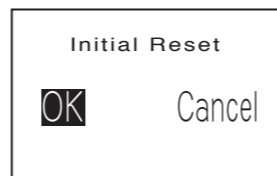

NOTE:
The password lock function and the password will be maintained even after an initial reset.

■ Explanations of each channel parameter and setting method

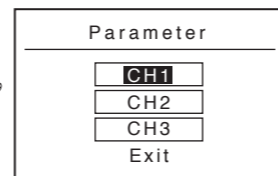
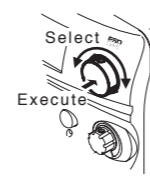

When the channel parameter is selected, the screen shown to the right will be displayed. When you select the channel you want to set here, it will switch to that channel's setting screen.

Turn the control knob when you want to change the selection, and press the control knob when you have made your choice.

The displayed screen for the channel parameters differs depending on which handpiece is connected, when handpieces other than hot air is connected, when hot air is connected, and when no handpiece is connected.

All handpieces EXCEPT Hot Air

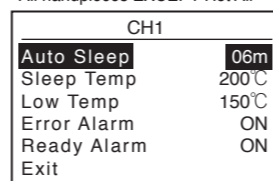

Hot Air Handpiece ONLY

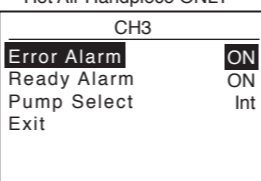

No Handpiece Connected

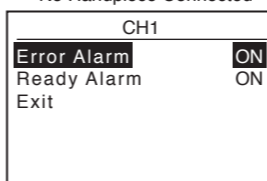

The reason the display screen is different is because the necessary setting items differ according to the connected handpiece. Below, the setting method for each item is illustrated.

● Auto Sleep

Select whether you want to activate the soldering iron's sleep function. When activated, the sleep function will turn on when then handpiece has been placed in the sleep holder for a set period of time and the temperature of the iron tip will drop* to a set temperature.



Select "OFF"

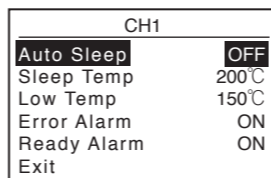

Select "On"

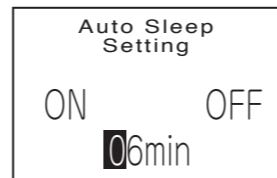

When changing your selection or changing the numerical value, turn the control knob and press the control knob when you have made your choice.

After the last digit has been accepted for the time setting, the screen will return to the previous screen as if the setting were OFF.

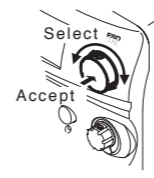

* The temperature when it is lowered is set as "Sleep Temp".

● Sleep Temperature

This sets the temperature when it is sleeping. The setting for the sleep temperature is not entered one digit at a time, the displayed temperature changes in 20 °C (36°F) increments by turning the operating knob. When the desired temperature is displayed, you can set it by pressing the operating knob.

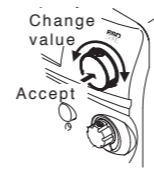

● Low Temp Alert Setting

Set the lower-limit error temperature. When this function is activated, if the sensor temperature goes below the lower-limit temperature, an error will be displayed and the warning buzzer will sound. Change the value by turning the control knob, and pressing the control knob to accept the value.

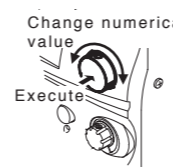
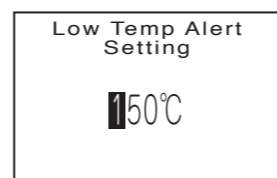

● Error Alarm Setting

You can set whether the buzzer will sound or not when an error occurs. Turn the control knob and select ON or OFF, and press the control knob to accept.

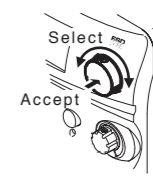

● Ready Alarm Setting

You can set whether the buzzer will sound or not when the iron tip, etc. has reached the set temperature and is ready for use. Turn the control knob and select ON or OFF, and press the control knob to accept.



● Pump Select for Hot-Air (HAKKO FM-2029 only)

For the air for the HAKKO FM-2029, select whether you will use the station's internal pump or external air.

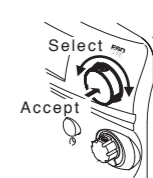

6. PARAMETER SETTINGS

● Temp Limit

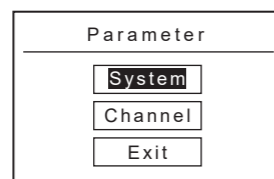
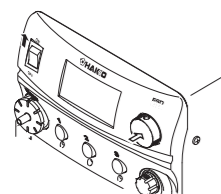

Change the Password Lock to "Partial" in the System parameters. Then select the Channel parameters. You will see that "Temp Limit" has now been added.

Channel setting screen

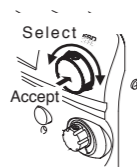
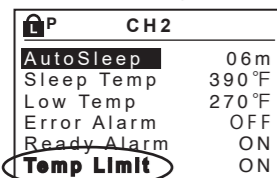

When you select the TEMP LIMIT channel parameter, you will be asked to enter your password.

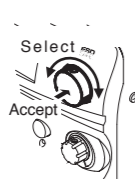
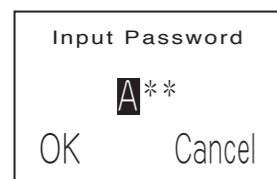

After entering your password, you may select "Upper Limit" or "Lower Limit" and enter values for each limit.

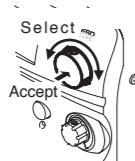
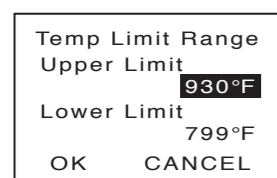

After selecting "OK", the feature is now enabled and you can change the temperature freely within the set temperature limit range.

NOTE :

If a present temperature that is programmed for the channel is within the temperature limit range, you will be allowed to select the preset freely. If the preset temperature is outside the temperature limit range, you will not be allowed to make the selection.

7. MAINTENANCE

Performing proper and periodical maintenance extends the product life. Efficient soldering depends upon the temperature, the quality and quantity of the solder and flux. Apply the following service procedure as dictated by the conditions of the usage.

⚠ WARNING

Since the handpiece tip/nozzle can reach a very high temperature, please work carefully. Except the case especially indicated, always turn the power switch OFF and disconnect the power plug before performing any maintenance procedure.

1 Temperature

High temperatures shorten tip life and may cause thermal shock to components. Always use the lowest possible temperature. The excellent thermal recovery characteristics of the HAKKO FM-206 ensure effective soldering at low temperatures.

2. Cleaning

Always clean the tip/nozzle before use to remove any residual solder or flux adhering to it. Use the tip cleaner or cleaning sponge. Contaminants on the tip have many deleterious effects, including reduced heat conductivity, which contribute to poor performance.

3. After use

Always clean the tip/nozzle and coat it with fresh solder after use. This guards against oxidation.

This procedure, if followed daily, will materially add to tip life.

- Set the temperature to 250°C (482°F).
- When the temperature stabilizes, clean the tip and check the condition of the tip. If the tip is badly worn or deformed, replace it.
- If the solder plated part of the tip is covered with black oxide, apply fresh solder, containing flux, and clean the tip again. Repeat until all the oxide is removed, then coat the tip with fresh solder.
- Turn the power OFF and remove the tip, using the heat resistant pad. Set the tip aside to cool.
- Remaining oxides, such as the yellow discoloration on the tip shaft, are not harmful but can be removed with isopropyl alcohol.

4. When the unit is not being used and the auto power shutoff is not active.

Never allow the unit to idle at a high temperature for extended periods. This will allow the tip to become oxidized. Turn the power switch OFF. If it is to be out of service for several hours, it is advisable to pull the power plug as well.

■ Maintenance of the electromagnetic valve and pump head

● Remove the cover

When performing maintenance on either the electromagnetic valve or the pump head, remove the screws holding the cover and take the cover off.

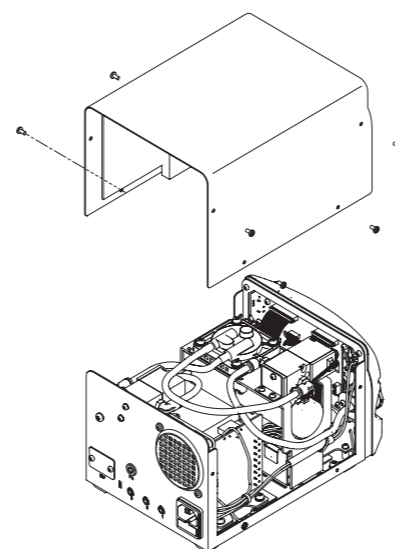

● Electromagnetic valve maintenance

- Remove the screws holding the electromagnetic valve in place.

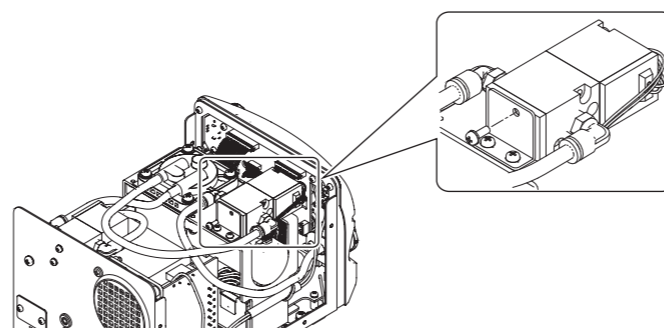

- Remove the bottom of the electromagnetic valve.

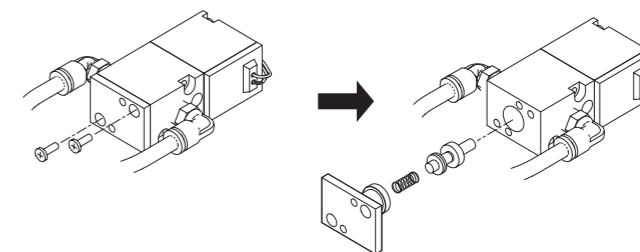

- Clean the parts that have flux attached to them, such as the inside of the electromagnetic valve, with alcohol.

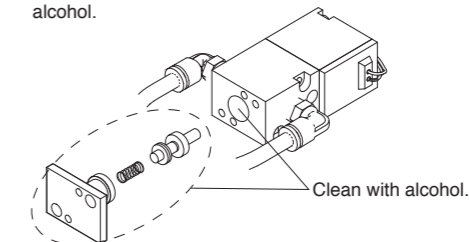

⚠ Caution
Do not use thinner when cleaning.

- Assembly is done in the opposite order of disassembly.

*There is one more electromagnetic valve. Remove the screws on the back of the chassis, and from that point on remove and clean following the same steps.

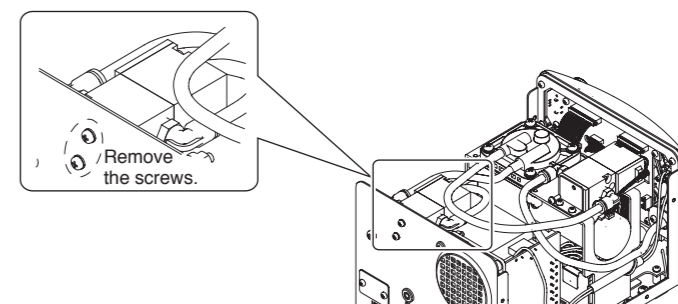

● Cleaning the pump head

- Remove the valve and valve guard and remove any attached flux.

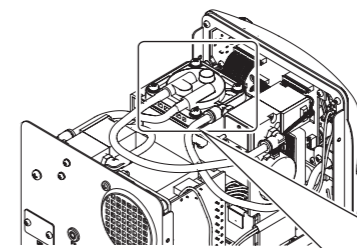

⚠ Caution
-When the valve guard is difficult to remove, please warm it with hot air. Please do not try to forcibly remove it with a screwdriver, etc. If the valve guard becomes deformed, it will no longer be airtight.
-Please clean with either alcohol or thinner.

Pump head disassembly
*It is resting on its side.
Clean the pump head, valve and valve guard.

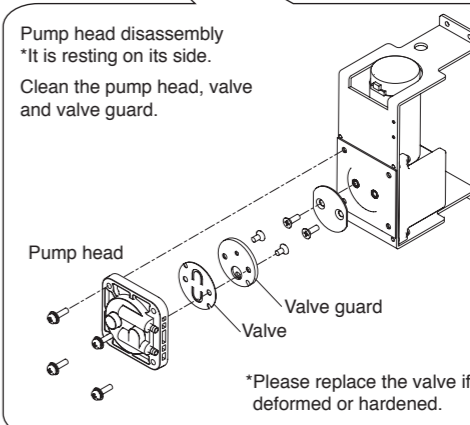

*Please replace the valve if it is deformed or hardened.

- Install the valve and valve guard.

⚠ Caution
When assembling the pump, please make sure to keep it airtight so that there are no air leaks.

8. CHECKING PROCEDURE

⚠ WARNING

Unless otherwise directed, carry out these procedures with the power switch OFF and the power UNPLUGGED.

■ Check for a broken heater or sensor

1. Check for a broken heater or sensor

Measure the resistance across this position.

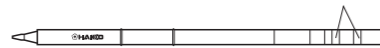

Verify the electrical integrity of the heater and sensor. Measure the resistance of the heater and sensor while at room temperature (15~25°C:59~77°F). It should be $8 \Omega \pm 10\%$. If the resistance exceeds these limits, replace the tip.

■ Check the grounding line

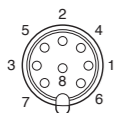

1. Unplug the connection cord from the station.
2. Measure the resistance value between Pin 2 and the tip.
3. If the value exceeds 2Ω (at room temperature), perform the tip maintenance described on section 2, maintenance for the tip. If the value still does not decrease, check the connection cord for breakage.

■ Checking the connection cord for breakage (HAKKO FM-2027)

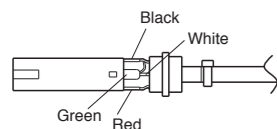

1. Remove the soldering tip and the sleeve assembly.
2. Turn the front piece of the HAKKO FM-2027 counterclockwise and remove the cover.
3. Measure the resistance values between the connector and the lead wires at the socket as follows:

Pin 1 – Red Pin 2 – Green
Pin 3 – Black Pin 5 – White

If any value exceeds 0Ω or is ∞ , replace the HAKKO FM-2027.

■ Replacing the fuse

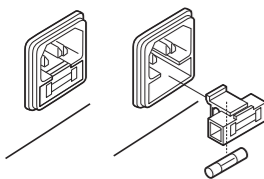

1. Unplug the power cord from the power receptacle.
2. Remove the fuse holder.
3. Replace the fuse.
4. Put the fuse holder back in place.

9. TROUBLE SHOOTING GUIDE

⚠ WARNING

Before checking the inside of the HAKKO FM-206 or replacing parts, be sure to disconnect the power plug. Failure to do so may result in electric shock.

- The unit does not operate when the power switch is turned on.

CHECK : Is the power cord and/or the connection plug disconnected?
ACTION : Connect it.
CHECK : Is the fuse blown?
ACTION : Replace the fuse. If the fuse blows again, send the unit in for repair.

- The tip does not heat up. "Sens Error" is displayed.

CHECK : Is the tip inserted properly?
ACTION : Insert the tip completely.
CHECK : Is the connection cord and/or the heater/sensor broken?
ACTION : If the cord assembly is broken, replace the soldering iron, desoldering tool or handpiece.

- Solder does not wet the tip.

CHECK : Is the tip temperature too high?
ACTION : Set the appropriate temperature.
CHECK : Is the tip contaminated with oxide?
ACTION : Remove the oxide

- The tip temperature is too high.

CHECK : Is the connection cord broken?
ACTION : If the cord assembly is broken, replace the soldering iron, desoldering tool or handpiece.

- The tip temperature is too low.

CHECK : Is the tip contaminated with oxide?
ACTION : Remove the oxide

- "Grip Error" is displayed.

CHECK : Is the handpiece connected?
ACTION : Remove and reinsert the handpiece.

- The low-temperature alarm tolerance error "Low Temp" is displayed.

CHECK : Is the tip too small for the items to be soldered?
ACTION : Use a tip with a larger thermal capacity.
CHECK : Is the setting value for the low-temperature alarm tolerance too low?
ACTION : Increase the setting value.

- Heater terminal short circuit error "Heater Short Error" is displayed.

CHECK : Is the appropriate HAKKO tip/nozzle being used?
ACTION : Turn the power switch OFF and insert the genuine HAKKO tip/nozzle. Turn the power switch ON.

- "Heat up Error" is displayed. (for MODEL FM-2023)

ACTION : Turn the power switch OFF and insert the genuine HAKKO tip. Turn the power switch ON.

- "Drive Error" is displayed. (for MODEL FM-2023)

CHECK : Is the tip left on the wet cleaning sponge?
ACTION : Turn the power switch off. Turn the power switch on again after removing the tip from the wet cleaning sponge.

- "Zero-Cross Error" or "System Error" is displayed.

ACTION : Turn off the power switch. Turn on the power switch again. If the "Zero-Cross Error" / "System Error" continues to be displayed after turning on the power switch, contact your HAKKO representative.

10. ERROR MESSAGE

● Sens Error

When there is the possibility that a failure has occurred in the sensor or heater (including the sensor circuit), "Sens Error" is displayed and the power is shut down.

● Grip Error

"Grip Error" will be displayed if the connector cord is not attached to the station OR the wrong soldering iron is connected.

● Low Temp

If the sensor temperature falls below the difference between the current temperature setting and the low-temperature alarm tolerance, "Low Temp" is displayed and the warning buzzer sounds. When the tip temperature rises to a value within the set tolerance, the buzzer will stop sounding.

EXAMPLE:

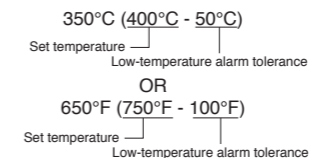

EXAMPLE:

Assume that the temperature setting is 400°C/750°F and the tolerance 50°C/100°F. If the temperature continues to decrease and finally falls below the value indicated below while the heating element is on, the displayed value starts blinking to indicate that the tip temperature has dropped.

● Heater Short Error

"Heater Short Error" will flash, and the buzzer will sound continuously, when the tip is inserted incorrectly, an incompatible tip is inserted, or a foreign object has found its way into the connector.

● Heat up Error (For MODEL FM-2023)

This is displayed in cases such as when the iron tip abnormally heats up relative to the set temperature when the micro-tweezers (MODEL FM-2023) are connected.

● Drive Error (For MODEL FM-2023)

This is displayed in cases such as when judged that an excessive pulse has been generated when the micro-tweezers (MODEL FM-2023) are connected.

● TRig Error

A "trig error" will occur if the trigger is pulled before the nozzle temperature has reached the set temperature. Please wait until the temperature reaches the set temperature and stabilizes.

● Zero-Cross Error

This is displayed when a zero-cross cannot be measured in the designated cycle. Should this error be displayed, please contact your HAKKO representative.

● System Error

This is displayed when the system is unable to operate normally. Should this error be displayed, please contact your HAKKO representative.

● Det Error

"Det Error" appears on the display when turning the power on after connecting the MODEL FM-2022/2023 with a hot tip. This is not an error. Wait for approximately 10 seconds until the model functions properly.

11. OPTION

● External switch (MODEL FM-2024)

An optional Foot Switch is available which can be connected to the unit to START/STOP the pump.

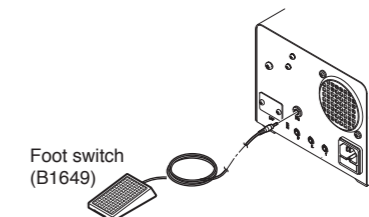

● Security lock

The HAKKO FM-206 comes with an anti-theft security slot.

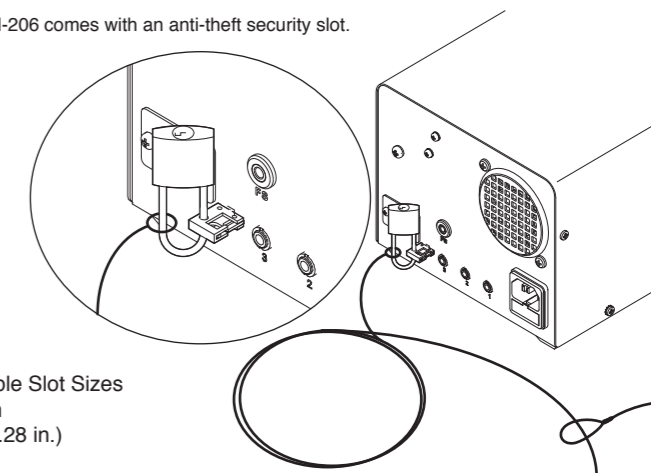

Compatible Slot Sizes
3 x 7 mm
(0.12 x 0.28 in.)

12. PARTS LIST

● HAKKO FM-206

Item No.	Part No.	Part Name	Specifications
①	A1613	Ceramic paper filter	10 pcs.
②	B1075	Elbow Union	
③	B2756	Tip tray	
④	B2384	Inlet	
⑤	B2852	Switch	
⑥	B2880	Vacuum outlet cap	With o-ring
⑦	B2954	O-ring	
⑧	B3752	Vacuum outlet retainer	
⑨	B3428	Motor	
⑩	B2419	Power cord, 3 wired cord & American plug	USA
	B2421	Power cord, 3 wired cord but no plug	220-240V
	B2422	Power cord, 3 wired cord & BS plug	India
	B2424	Power cord, 3 wired cord & European plug	220V KTL 230V CE
	B2425	Power cord, 3 wired cord & BS plug CE	230V CE U.K
	B2426	Power cord, 3 wired cord & Australian plug	
	B2436	Power cord, 3 wired cord & Chinese plug	China
	B3508	Power cord, 3 wired cord & American plug(B)	
	B3550	Power cord, 3 wired cord & SI plug	
	B3616	Power cord, 3 wired cord & BR plug	
⑪	A1583	Valve plate	
⑫	A1584	Diaphragm	
⑬	B3667	Solenoid valve	
⑭	B3668	Pump frame	
⑮	B3669	Pump head	
⑯	B3670	Diaphragm setting plate	
⑰	B3671	Fixing plate	
⑱	B3672	Crank shaft	
⑲	B3673	Crank	
⑳	B3674	Fuse/250v-7a	100-120V
	B3675	Fuse/250v-4a	220-240V
㉑	B3676	Transformer/100-120v	
	B3677	Transformer/220-240v	
㉒	B3678	P.W.B./transformer	Transformer
㉓	B3679	P.W.B./with front panel & valve	Temp. Control & display
㉔	B3681	Inner hose	6mm×100L
㉕	B3682	Inner hose	6mm×115L
㉖	B3683	Inner hose	6mm×220L
㉗	B3684	Inner hose	3mm×170L

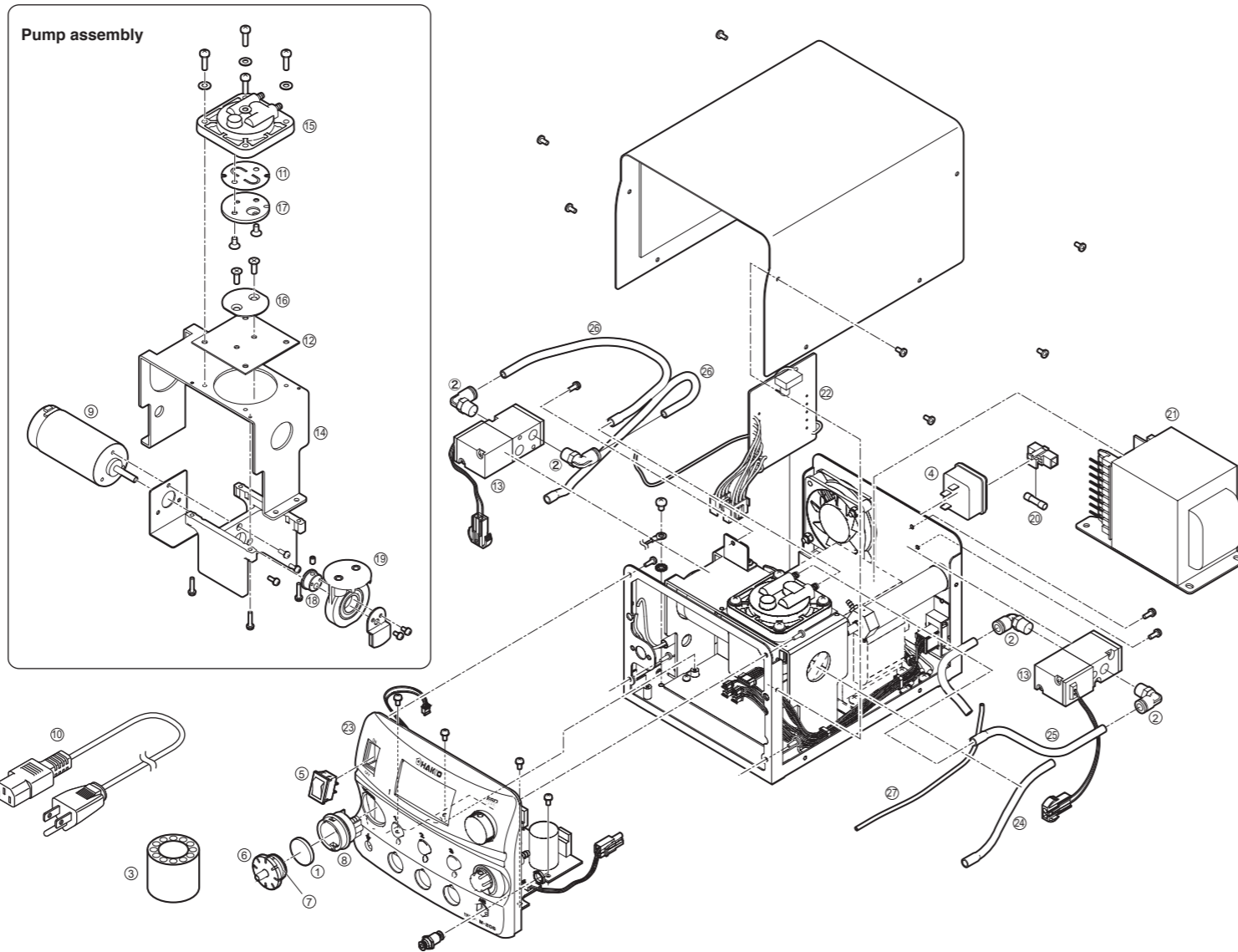

● HAKKO FM-2027

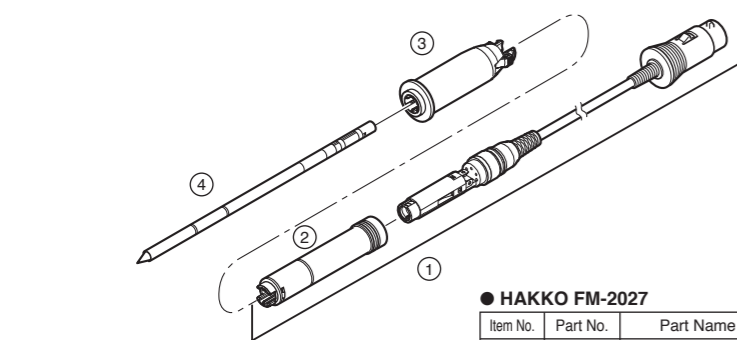

● HAKKO FM-2027

Item No.	Part No.	Part Name	Specifications
①	FM2027-02	Connector Assembly	24V-70W
②	B3215	Connector Cover	
③	B3216	Sleeve Assembly	Yellow
	B3217	Sleeve Assembly	Orange
	B3218	Sleeve Assembly	Blue
	B3219	Sleeve Assembly	Green
④		Tip	
⑤	B2300	Heat Resistant Pad	
⑥	B3253	Connecting Cable	

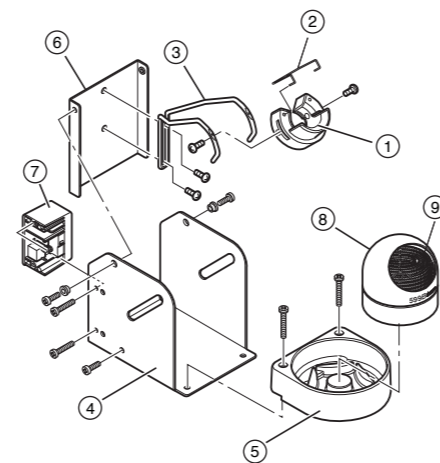
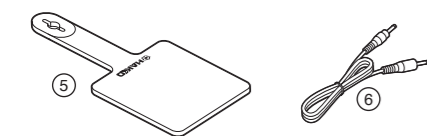

● Iron Holder

Item No.	Part No.	Part Name	Specifications
①-⑨	FH200-01	Iron holder	With 599B

● Iron Holder Parts

Item No.	Part No.	Part Name	Specifications
①	B3001	Iron receptacle	With screws
②	B2791	Tip fixing spring	
③	B3248	Holder for iron receptacle	
④	B3251	Iron holder base	With rubber feet
⑤	B3249	Cleaner base	With rubber feet
⑥	B3250	Stay	
⑦	B3252	Switch case assembly	
⑧	599B-02	Tip cleaner	
⑨	599-029	Cleaning wire	

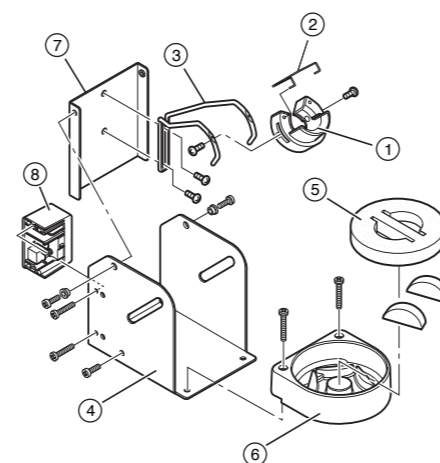

● Iron Holder

Item No.	Part No.	Part Name	Specifications
①-⑧	FH200-02	Iron holder	With Cleaning sponge

● Iron Holder Parts

Item No.	Part No.	Part Name	Specifications
①	B3001	Iron receptacle	With screws
②	B2791	Tip fixing spring	
③	B3248	Holder for iron receptacle	
④	B3251	Iron holder base	With rubber feet
⑤	A1536	Cleaning sponge	
⑥	B3249	Cleaner base	With rubber feet
⑦	B3250	Stay	
⑧	B3252	Switch case assembly	