

# Hestia 1400 Guillotine Tunnel

BASIC INSTALL SHEET

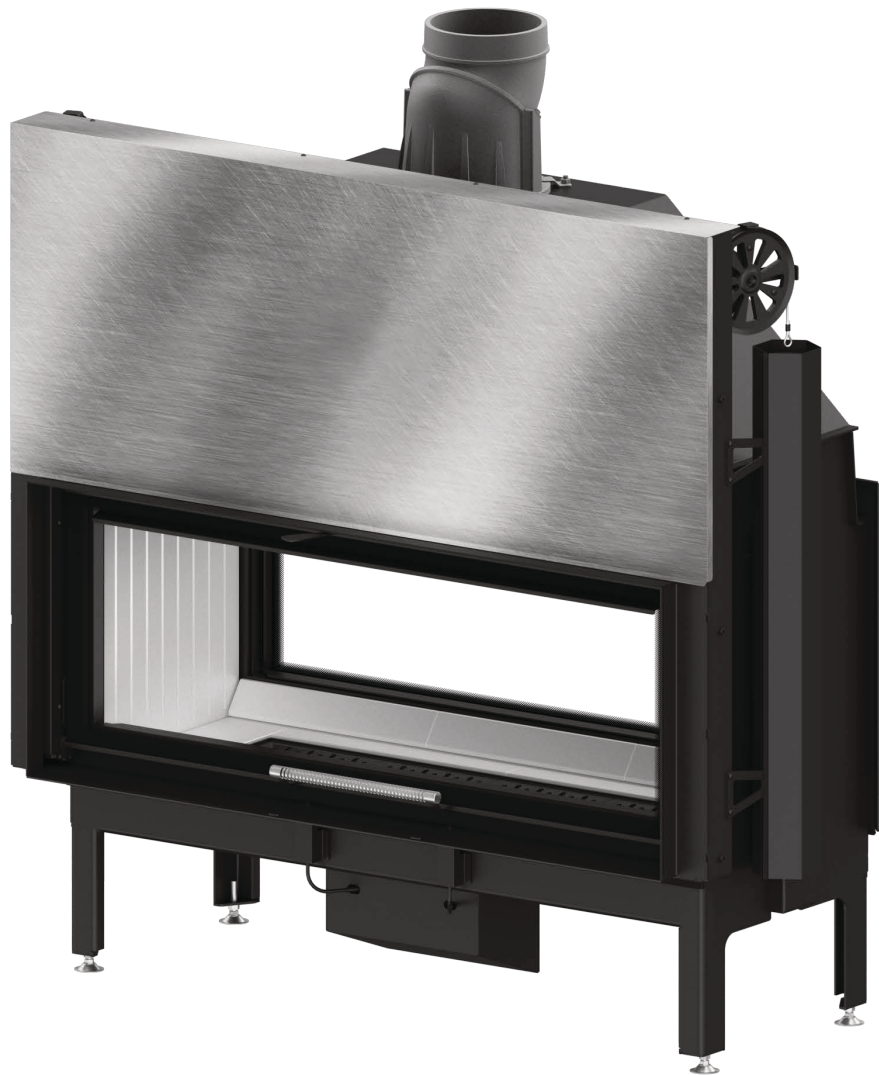

Version 1 11/11/23

Contents of manual may be updated without notice.

For the latest version of this manual please refer  
to our website: [www.livingfire.com.au](http://www.livingfire.com.au)

**PAUL AGNEW** | **DESIGNS**

# Hestia 1400 GUILLOTINE TUNNEL

## FIREBOX DIMENSIONS

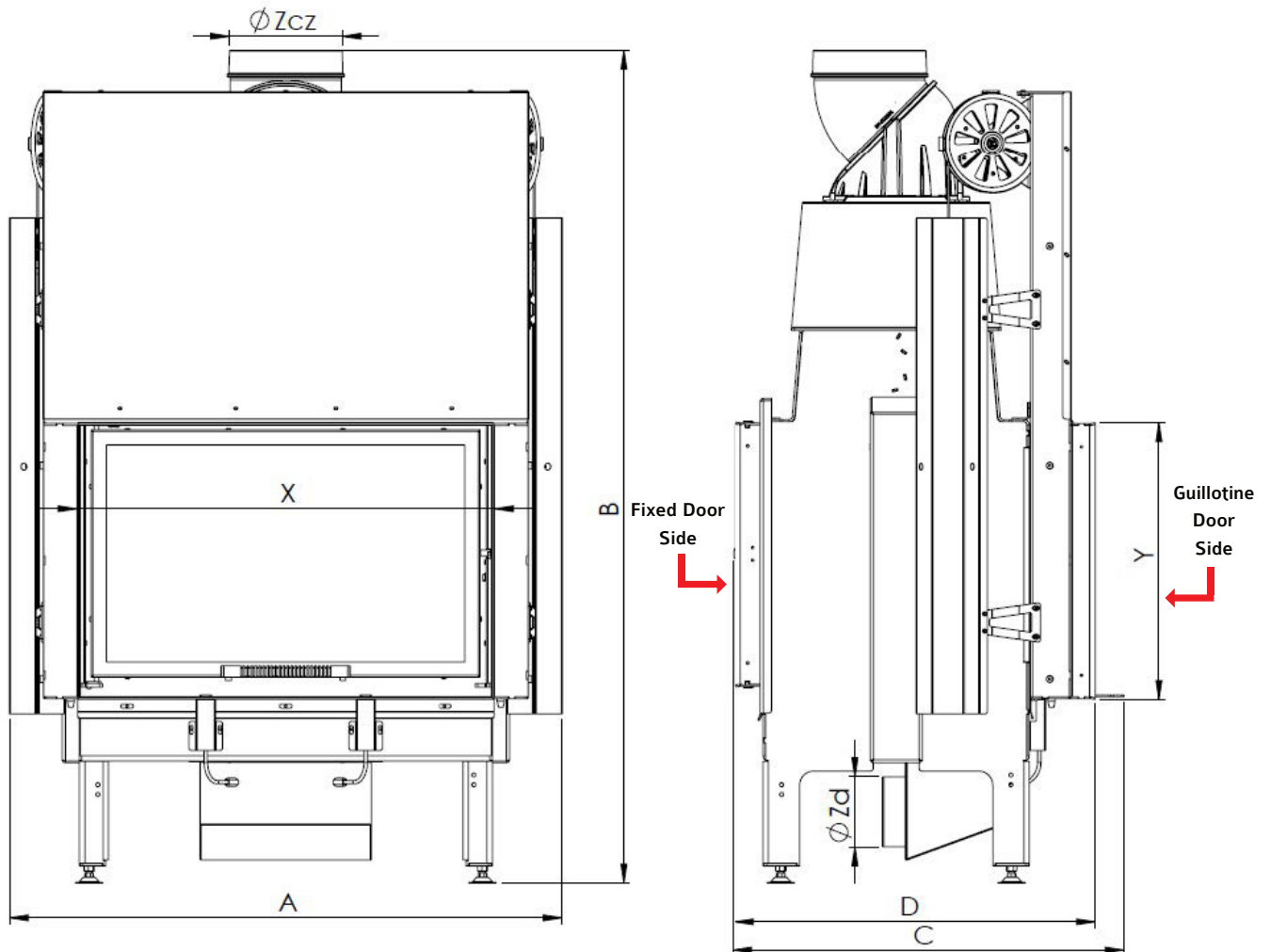

Dimensions [mm]	Hestia 1400 Guillotine Tunnel
A	1474
B	1604
C	708
D	634
X	1253
Y	492
Zcz	200
Zd	125

# Hestia 1400 GUILLOTINE TUNNEL

## HEBEL ENCLOSURE

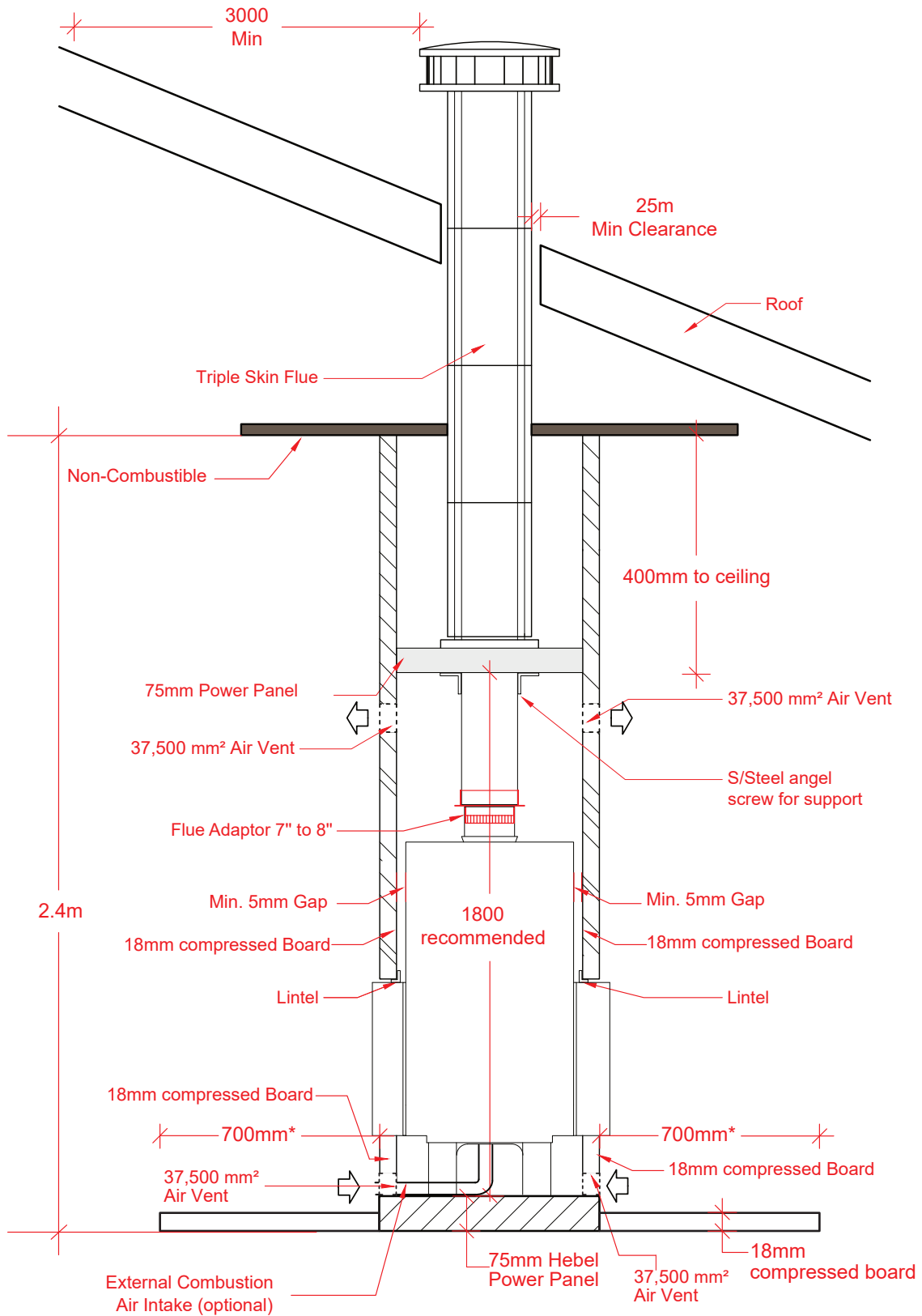

# Hestia 1400 GUILLOTINE TUNNEL

## HEBEL ENCLOSURE

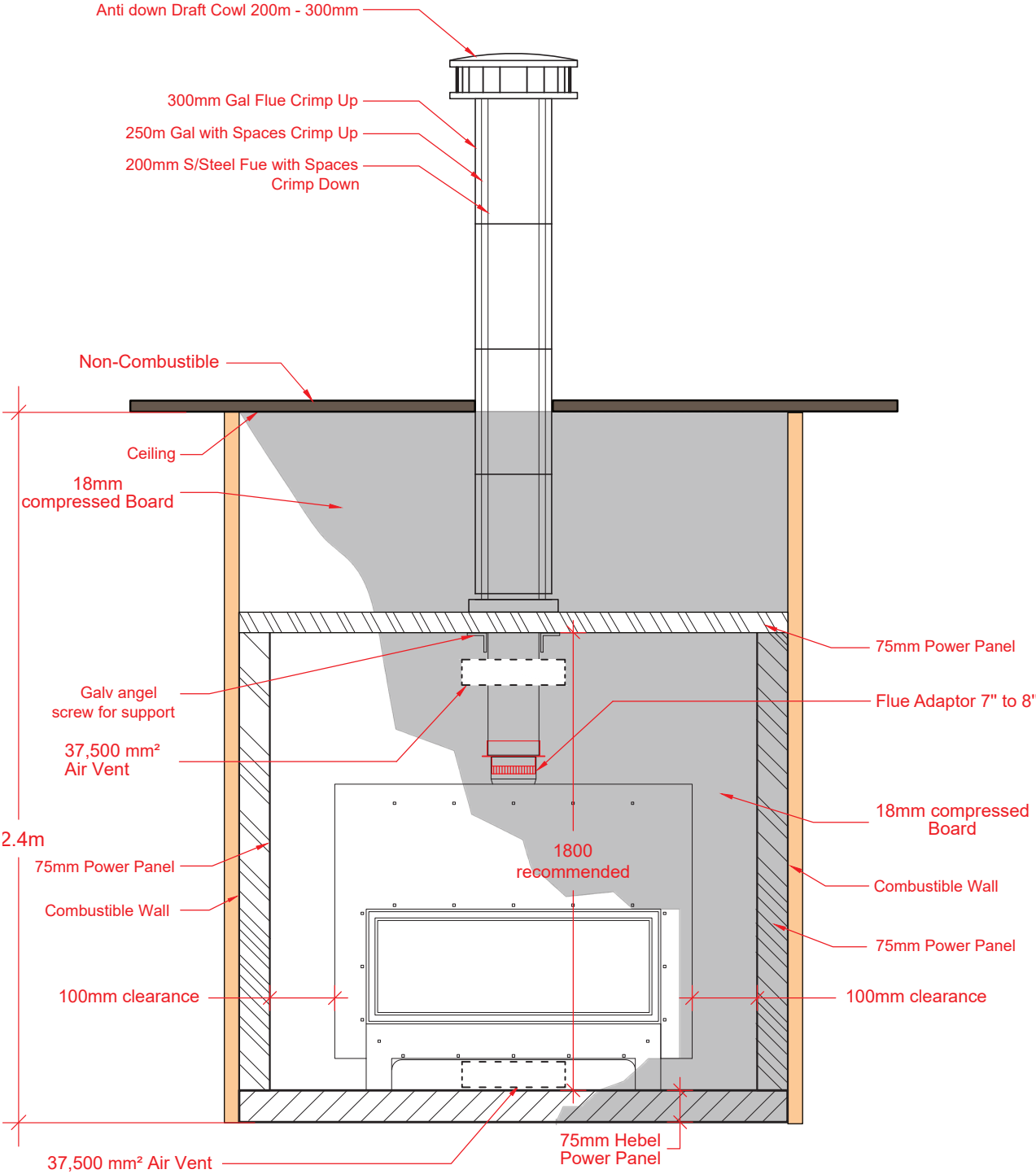

# Hestia 1400 GUILLOTINE TUNNEL

## AIR VENTS

75mm Hebel Power Panel
  Combustible wall
  18mm Compressed Board

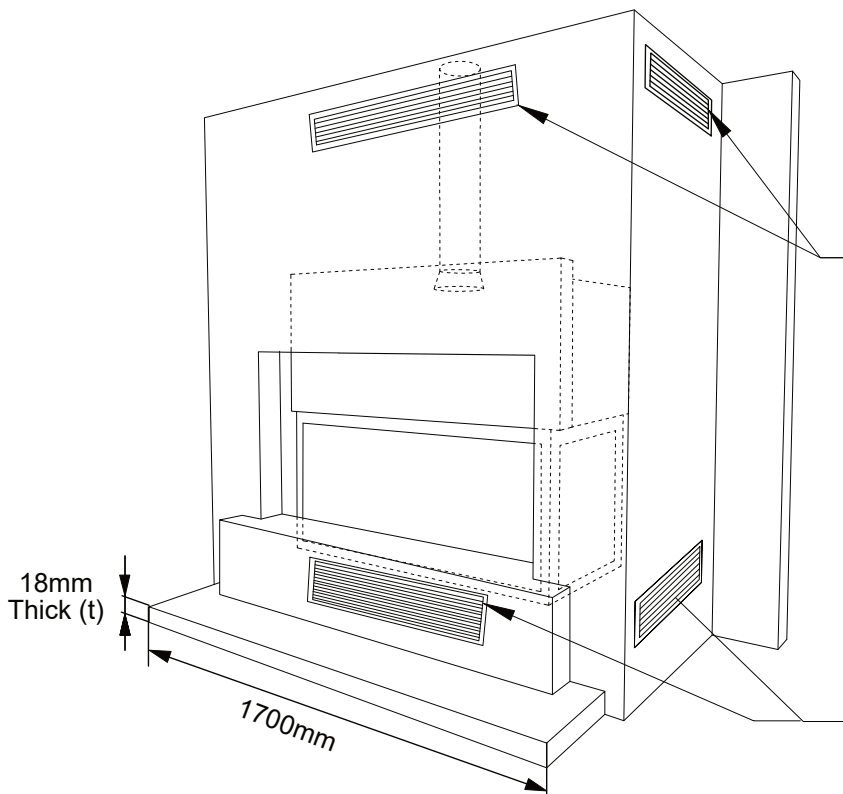
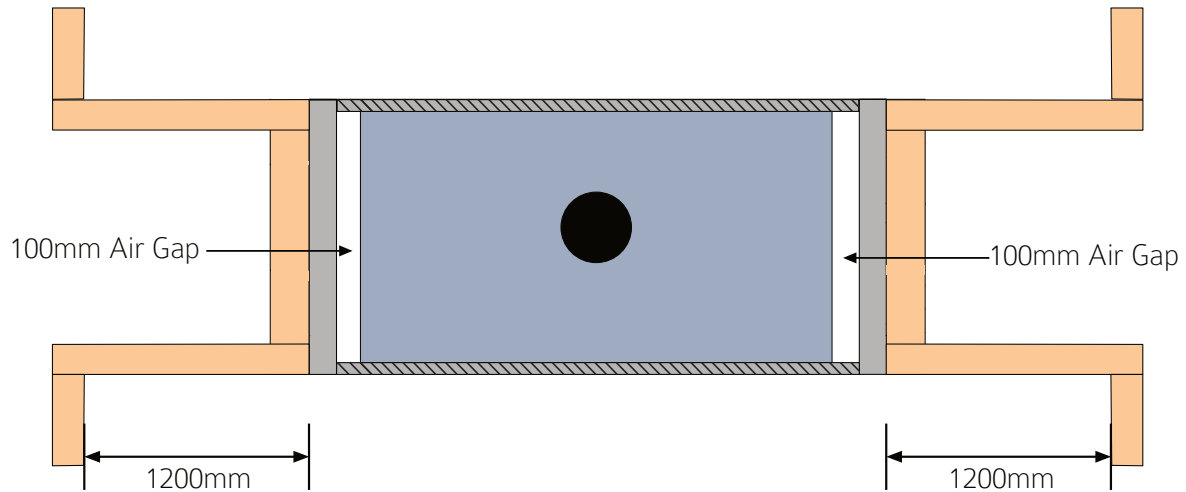

A minimum surface area of 375cm<sup>2</sup> is required for air outlet at the front of the cavity (directly below the internal deflector plate) on both sides. Optional side outlet grilles may be used for better heat dispersion however needs a 1200mm clearance from any combustible side structure

**Air inlet Grille**  
A minimum surface area of 375cm<sup>2</sup> is required for air intake on either side of the bottom of the cavity underneath the unit, in line with the base of the fireplace. The air intake grill may alternatively be placed on each side of the cavity as well

### Notes:

1. Air outlet grilles minimum air flow area required = 375cm<sup>2</sup>.
2. Air inlet grilles minimum air flow area = 375cm<sup>2</sup>.
3. All dimensions in millimeters.
4. Do not scale from these diagrams.
5. Air transfer kits mandatory for exempt units to comply to AS/NZ 4012/4013:2014. Fan optional depending on duct length.

**IMPORTANT: NO BRICKWORK TO BE COMMENCED UNTIL FIREBOX IS PLACED IN POSITION**

# Hestia 1400 GUILLOTINE TUNNEL

---

## Hearth Clearance information

---

Please refer to the table below for the reference to your hearth. The 'A' measurements references the height of the unit off the floor and the 'B' measurement references the forefront of the hearth from the glass of the heater.

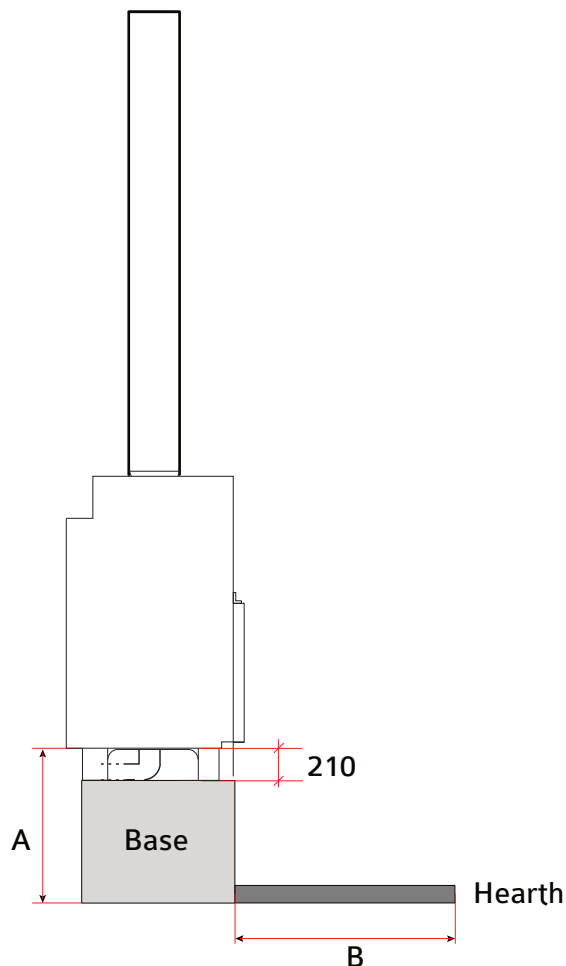

A	B
285 (minimum)	700
400	640
500	565
600	460
700	300 (minimum)