



DUO3 BASSINET

PRODUCT MANUAL

**IMPORTANT! READ CAREFULLY
AND KEEP FOR FUTURE REFERENCE**

The Babybee DUO3 is designed and tested to comply with: Consumer
Protection Notice No. 8 of 2007, AS 2088:2022 & AS/NZS ISO 8124-3

THANK YOU FOR CHOOSING BABYBEE!

Since 2015, we've been on a mission to make the very best baby products that make #parentlife better. Less stressful, more stylish, and more fun.

Welcome to the family!



WHAT'S IN THE BOX?

**Please check that you have all the correct parts
before getting started.**

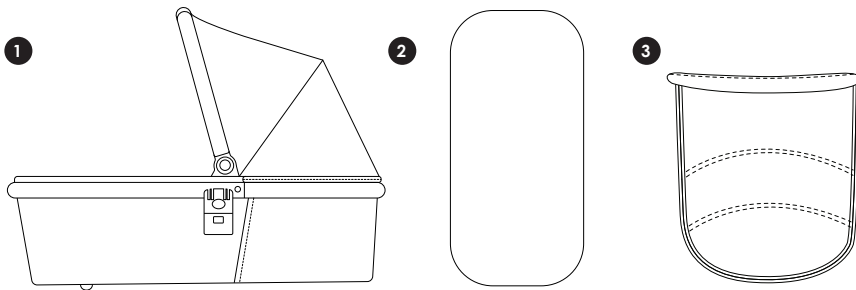

1. Bassinet

2. Mattress

3. Bassinet cover

SAFETY FIRST

⚠ WARNING

- FOLLOW THE MANUFACTURER'S INSTRUCTIONS.
- PUT ON ALL THE BRAKES WHENEVER YOU PARK THE STROLLER.
- DO NOT LEAVE CHILDREN UNATTENDED.
- DO NOT CARRY EXTRA BAGS ON THIS STROLLER.
- MAKE SURE CHILDREN ARE CLEAR OF ANY MOVING PARTS IF YOU ADJUST THE STROLLER OTHERWISE THEY MAY BE INJURED.

- Approved for use with the Babybee DUO range only.
- Maximum weight that can be carried in the bassinet is 9kg.
- Do not use or leave the bassinet near open fire or exposed flame.
- Never leave rain covers or blankets on or over the stroller indoors, in a hot climate or near a heat source. Always supervise whilst covered.

SETTING UP YOUR BASSINET

1 Using the fabric straps, pull the frame support rods towards the ends of the bassinet until they lock under the 4 plastic clips. **Note:** if they don't insert easily, simply lift the clip up to help guide the rods into place.

2 Zip up the fabric and insert the bassinet mattress.

3 Zip on the bassinet cover. Secure the press studs.

4 To release the canopy, press the round buttons on the sides of the canopy frame. **Note:** Do not put downward pressure on the canopy until the buttons are completely depressed or it will feel stuck and not move.

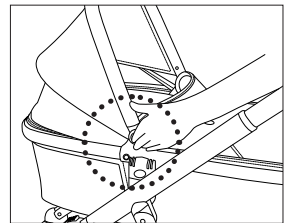
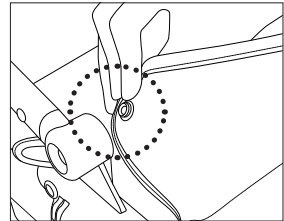
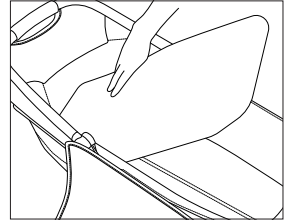
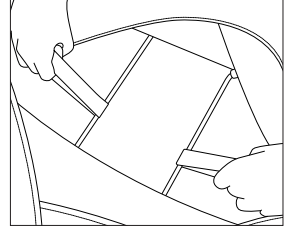

NOTE: To reduce the risk of SIDS, paediatricians recommend healthy infants be placed on their backs to sleep, unless otherwise advised by your physician.

SETTING UP YOUR BASSINET

Attaching & releasing the bassinet from the frame

Attach the bassinet onto either the central connectors of the frame for single mode or the double adaptors for double mode. To release, press the buttons and lift the bassinet up off the frame. The bassinet can face either direction.

Using the sun visor

The bassinet has an inbuilt sun visor. Please be gentle when pulling this out to avoid the rod weakening over time.

Using the ventilation panel

The head end of the bassinet fabric can be unzipped to expose a mesh panel, allowing additional air flow.

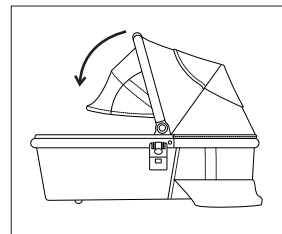
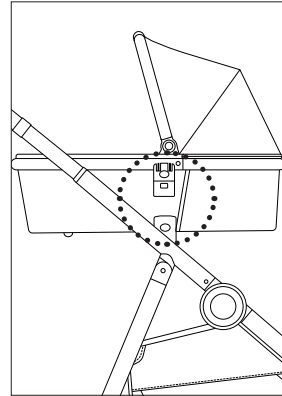

⚠ WARNING

- DO NOT USE THIS BASSINET ONCE THE CHILD CAN SIT UP UNAIDED.
- DO NOT USE FOR UNSUPERVISED SLEEPING.
- DO NOT ADD AN ADDITIONAL MATTRESS OR PADDING INSIDE THE BASSINET.

USING YOUR BASSINET

Rain cover (included in the stroller box)

The rain covers are compatible with both seat and bassinet. Simply place it over the bassinet as shown (right). The open flap should be at the top, this is to access the bassinet handle.

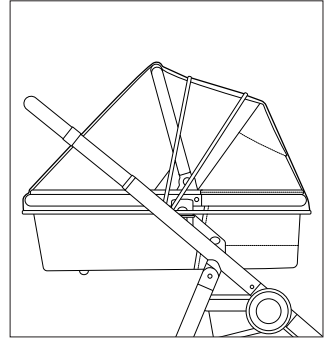

Sleeping

The DUO3 Bassinet is not designed for overnight sleeping. Day sleeping is OK under regular supervision.

Cleaning

The bassinet lining and mattress liner can both be removed and hand washed according to the instructions on the fabric care labels.

Designer Style. Unbeatable Value.

 **babybee**

MODEL: BABYBEE DUO3

VERSION: 1 | JAN 2023

Slight variations in the design of your stroller to the images shown in this manual may be present. Most recent versions can be found on our website.

babybeeonline.com