



# DUO3 BASSINET & SEAT SET

---

PRODUCT MANUAL

---

**IMPORTANT! READ CAREFULLY  
AND KEEP FOR FUTURE REFERENCE**

**The Babybee DUO3 is designed and tested to comply with:** Consumer Protection Notice No. 8 of 2007, AS 2088:2022 & AS/NZS ISO 8124-3



# THANK YOU FOR CHOOSING BABYBEE!

---

Since 2015, we've been on a mission to make the very best baby products that make #parentlife better. Less stressful, more stylish, and more fun.

Welcome to the family!



# CONTENTS

- 5. Safety warnings
- 8. What's in the box?
- 9. Setting up your frame
- 10. Folding your DUO3
- 11. Double or single mode?
- 12. Configurations
- 13. Setting up your bassinet
- 14. Using your bassinet
- 15. Setting up your seat
- 17. Using your harness
- 18. Using your DUO3
- 18. Rear Brake
- 18. Adjusting the footrest
- 19. Front swivel wheels
- 19. Rear wheels
- 20. Adjusting the handlebar
- 21. Accessories
- 22. Using your DUO3 with a car capsule
- 24. Keeping your stroller in tip-top shape
- 26. Warranty

**Read all instructions before assembling and using the product**

# SAFETY FIRST

## **⚠ WARNING**

- FOLLOW THE MANUFACTURER'S INSTRUCTIONS.
- PUT ON ALL THE BRAKES WHENEVER YOU PARK THE STROLLER.
- DO NOT LEAVE CHILDREN UNATTENDED.
- DO NOT CARRY EXTRA BAGS ON THIS STROLLER.
- MAKE SURE CHILDREN ARE CLEAR OF ANY MOVING PARTS IF YOU ADJUST THE STROLLER OTHERWISE THEY MAY BE INJURED.

### **Maximum weight limits**

- Maximum weight for a child in the bassinet is 9kg.
- Maximum weight for a child in the seat is 20kg .
- Maximum weight for items in the basket is 12kg.
- Maximum weight for items in the handlebar bag is 2kg.

# SAFETY FIRST

- Do not use parts or accessories that are not approved for use with the Babybee DUO range. Doing so may be unsafe and may also void your warranty.
- Do not lift or carry the stroller when occupied by your child.
- This is not a toy. Do not allow your child to climb, stand on or play with the stroller.
- Do not use the stroller in a manner for which it is not designed.
- Only to be used for walking. Not suitable for running, rollerblading or skating etc.
- Remove your child and fold the stroller when going up or down stairs or escalators.
- Take your child out of the stroller when travelling by bus, tram or train.
- Gentle sloping surfaces may be unstable. On steeper sloping and uneven surfaces, there is a possibility that the stroller may tip over and you may need to remove your child.
- Do not use if any part is broken, torn or missing. Replacement parts are available from our website or by contacting us.
- Do not use or leave the stroller near open fire or exposed flame.
- Do not overload the stroller with additional children, bags or other items.
- Do not allow children to stand on the axle / brake bar between the wheels. This is unsafe and could damage the stroller.
- If the stroller is being used by someone unfamiliar with it (such as grandparents) always explain to them how the stroller works and its safety features.

# SAFETY FIRST

## **⚠ WARNING**

WHEN USING THE STROLLER WITH ONE CHILD, THE LOWER ADAPTORS MUST NOT BE USED.

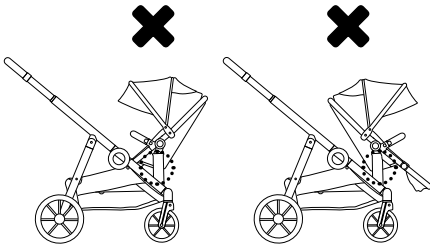

## **⚠ WARNING**

WHEN USING THE FRONT SEAT IN PARENT FACING MODE THE SEAT CANNOT BE RECLINED.

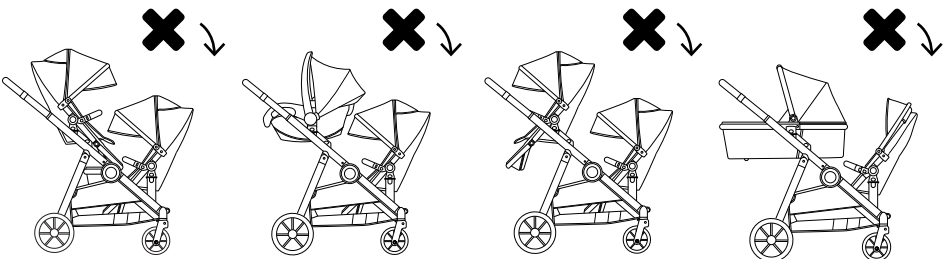

# WHAT'S IN THE BOX?

Please check that you have all the correct parts before getting started.

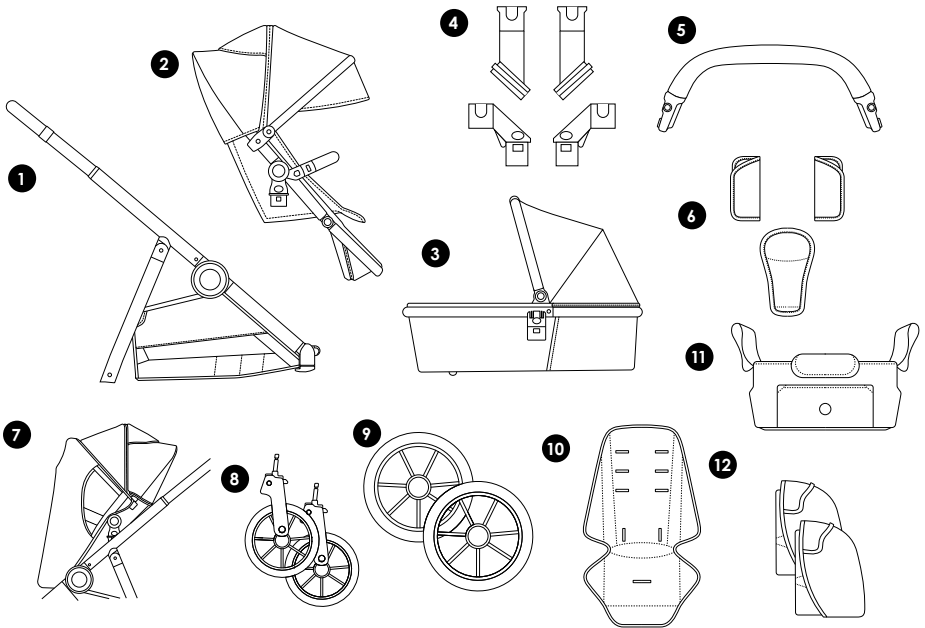

- |                    |                   |                     |
|--------------------|-------------------|---------------------|
| 1. Stroller frame  | 5. Belly bar      | 9. Rear wheels      |
| 2. Stroller seat   | 6. Harness covers | 10. Seat liner      |
| 3. Bassinet        | 7. Seat UV cover  | 11. Handlebar bag   |
| 4. Double adaptors | 8. Front wheels   | 12. 2 x Rain covers |



# SETTING UP YOUR FRAME

- 1 To open the frame, release the black frame lock.
- 2 Lift the handlebar upwards until you hear the frame 'click' into place.
- 3 Thread the basket tab through the slot behind the rear wheel hub and secure the press stud. Repeat for the other side.
- 4 Insert each wheel pin into the sides of the brake bar until you hear a 'click'. Give them a tug to ensure they are attached securely.
- 5 Insert each front wheel pin into the centre of the socket ensuring you hear them 'click' in. Give them a tug to ensure they are attached securely.

**Your frame is now set up!**

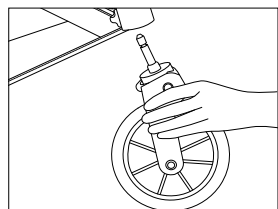
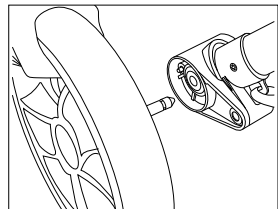
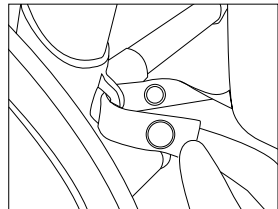
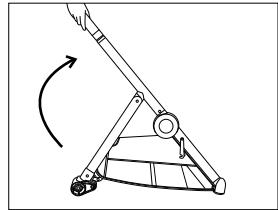
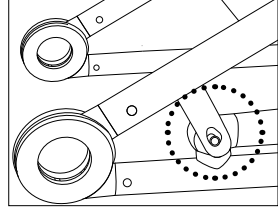

# FOLDING YOUR DUO3

- 1 Before folding, ensure that the brake is engaged, the front wheels are unlocked, and the handlebar is at the lowest height position.
- 2 Remove the second seat, bassinet, or capsule by lifting the release levers on either side (the stroller can be folded with one seat in the forward facing position only).
- 3 Standing at the front of the stroller, slide the black buttons located on the black circular handles and the frame will fold in half.
- 4 Ensure the automatic frame lock has engaged on the side of the stroller before lifting the frame up using the circular handles.

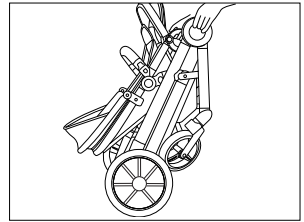
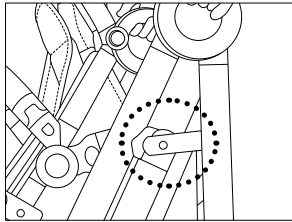
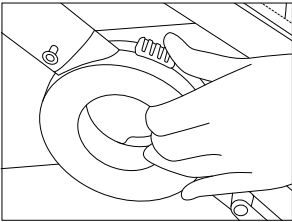

## ⚠ WARNING

- ENSURE CHILDREN ARE OUT OF REACH OF THE STROLLER BEFORE FOLDING.
- TAKE EXTRA CARE WHEN FOLDING, LIFTING, AND CARRYING THE STROLLER. ALWAYS LIFT AND CARRY YOUR STROLLER USING BOTH HANDS.
- TO AVOID POSSIBLE INJURY, ALWAYS ENSURE THAT THE FRAME LOCK IS SECURED BEFORE LIFTING AND CARRYING THE STROLLER.
- TO AVOID FINGER ENTRAPMENT, KEEP YOUR OWN AND YOUR CHILDREN'S FINGERS CLEAR OF ANY FOLDING PARTS.
- ALWAYS REMOVE THE CAR CAPSULE, BASSINET OR SECOND SEAT PRIOR TO FOLDING AND CARRY THE FRAME AND SEAT/BASSINET SEPARATELY. ONLY LIFT AND CARRY THE STROLLER AFTER FOLDING.

# DOUBLE OR SINGLE MODE?

## Single Mode

When using the stroller in single mode, the lower adaptors **must not be used**. The upper adaptors can however be used. The bassinet or seat can be attached directly into the upper adaptors or into the central connectors on the frame.

## Double Mode

Attach the two sets of double adaptors. The upper adaptors slot into the central connectors for the "upper position". To remove them simply push the buttons on the side and lift off.

The lower adaptors will slide onto the guides at the front of the frame for the "lower position". To remove them you will need to release the tab at the top of the adaptor before sliding off.

Upper Adaptors

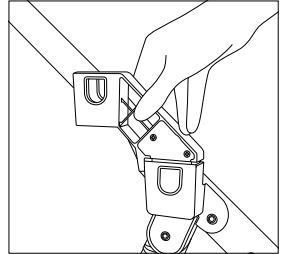

Lower Adaptors

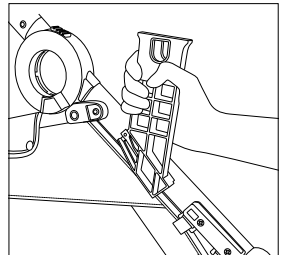

## **⚠ WARNING**

THERE IS AN INCREASED RISK OF THE STROLLER TIPPING WHEN ONLY ONE CHILD IS IN THE STROLLER IN DOUBLE MODE. PLEASE BE MINDFUL OF THIS WHEN LOADING YOUR CHILDREN INTO THE STROLLER.

# CONFIGURATIONS

## Single mode:



## Seat + bassinet:



You can purchase an additional seat, bassinet, or capsule adaptors on our website to enable the following configurations.

## Two seats:

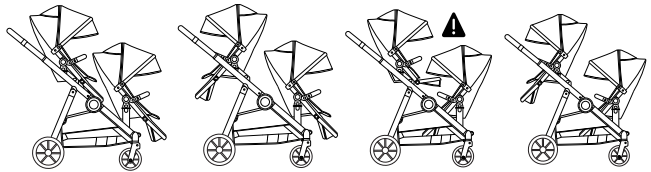

## Two bassinets:

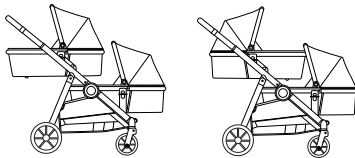

## Car Capsules:

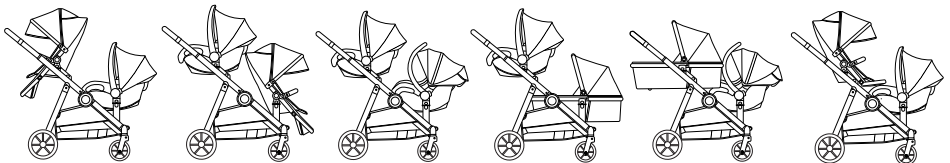

**!** **NOTE:** In double seat mode with the seats facing each other, the foot rest of the top seat must be in the most upright position.

# SETTING UP YOUR BASSINET

- 1** Using the fabric straps, pull the frame support rods towards the ends of the bassinet until they lock under the 4 plastic clips. **Note:** if they don't insert easily, simply lift the clip up to help guide the rods into place.
- 2** Zip up the fabric and insert the bassinet mattress.
- 3** Zip on the bassinet cover. Secure the press studs.
- To release the canopy, press the round buttons on the sides of the canopy frame. **Note:** Do not put downward pressure on the canopy until the buttons are completely depressed or it will feel stuck and not move.
- 4**

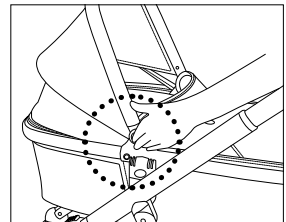
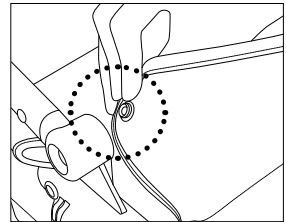
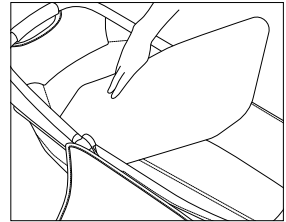
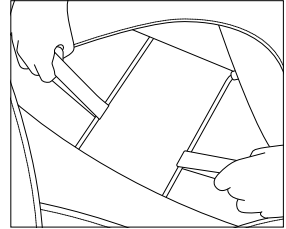

**NOTE:** To reduce the risk of SIDS, paediatricians recommend healthy infants be placed on their backs to sleep, unless otherwise advised by your physician.

# USING YOUR BASSINET

## Attaching & releasing the bassinet from the frame

Attach the bassinet onto either the central connectors of the frame for single mode or the double adaptors for double mode. To release, press the buttons and lift the bassinet up off the frame. The bassinet can face either direction.

## Using the sun visor

The bassinet has an inbuilt sun visor. Please be gentle when pulling this out to avoid the rod weakening over time.

## Using the ventilation panel

The head end of the bassinet fabric can be unzipped to expose a mesh panel, allowing additional air flow.

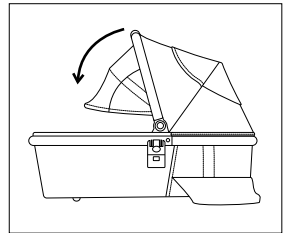
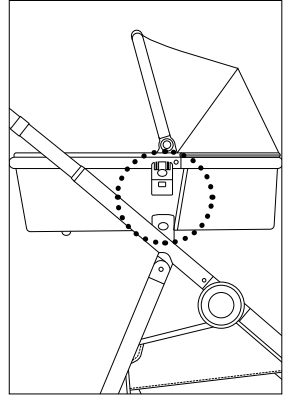

## ⚠ WARNING

- DO NOT USE THIS BASSINET ONCE THE CHILD CAN SIT UP UNAIDED.
- DO NOT USE FOR UNSUPERVISED SLEEPING.
- DO NOT ADD AN ADDITIONAL MATTRESS OR PADDING INSIDE THE BASSINET.

# SETTING UP YOUR SEAT

1

Line up the seat connectors with the frame and press downwards. Listen for the 'click' and ensure it is securely locked in place.

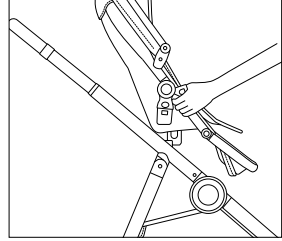

2

Attach the plastic canopy connectors onto the sides of the frame (TIP: attach from top to bottom). The connectors should attach over the round guides on the frame.

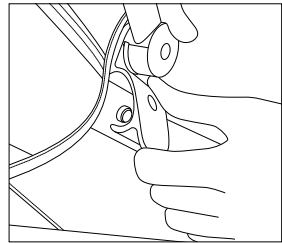

**Note:** For additional headroom you can attach the canopy connectors higher up the frame, above the guides.

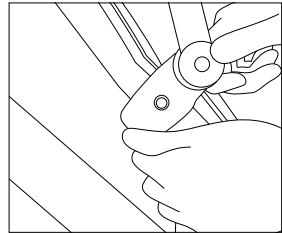

3

Insert the belly bar into the belly bar sockets on the seat frame. Always give the bar a firm tug to ensure it's secure.

To remove from one side or both, press the button on the side you want to release, and pull the belly bar out.

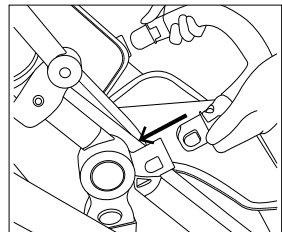

# SETTING UP YOUR SEAT

## To recline the seat

Press the large, round buttons on the sides of the seat connectors and tilt the seat forward or back.

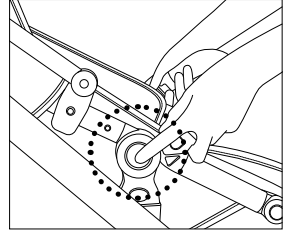

## To remove the seat

Press the oval buttons on the sides of the seat connectors and lift up.

**Note:** The seat can face either direction.

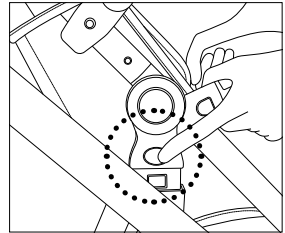

## **⚠** WARNING

- THE STROLLER SEATS ARE NOT RECOMMENDED FOR CHILDREN UNDER 6 MONTHS.
- THIS STROLLER SEATS TWO PASSENGERS WITH A MAXIMUM WEIGHT LIMIT OF 20KG EACH.
- DO NOT ALLOW YOUR CHILD TO CLIMB UNASSISTED INTO THE STROLLER.



# USING YOUR HARNESS

## To secure and release the harness

Insert each of the 4 harness straps into the central buckle.

To release, press the button in the middle of the buckle.

## To adjust the length of the shoulder straps

Slide the buckle along the strap to the desired position.

## To adjust the height of the shoulder straps

Thread the strap through the correct loop on the seat and then through the corresponding slot on the seat liner.

## To adjust the length of the waist straps

Pull the adjustor buckle along the waist strap to the desired length.

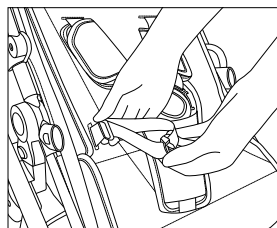
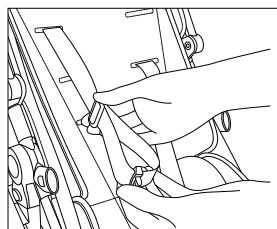
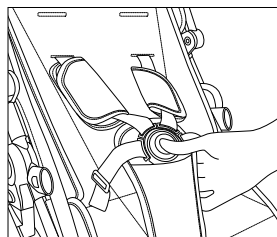

## **⚠** WARNING

- SECURE THE CHILD IN THE HARNESS AT ALL TIMES.
- ENSURE THAT YOUR CHILD CORRECTLY WEARS THE FITTED AND ADJUSTED SAFETY HARNESS AT ALL TIMES WITH ALL 5 STRAPS SECURED.
- NEVER LEAVE THE HARNESS BUCKLED WHEN NOT FITTED TO A CHILD IN THE STROLLER BECAUSE THE HARNESS CAN FORM LOOPS WHICH MAY POSE A STRANGULATION HAZARD.

# USING YOUR DUO3

## Rear Brake

When stopped, use the brake at all times by pressing down on the bottom of the red brake paddle with your foot until you feel it click into place.

1

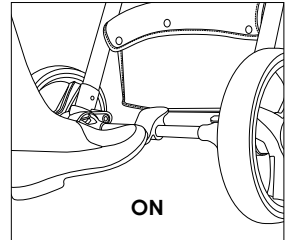

To start travelling again press down on the top of the red brake paddle with your foot to disengage the brake and off you go!

2

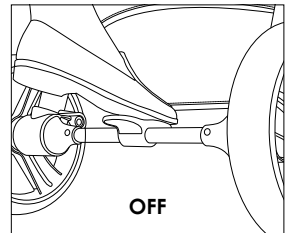

## Adjusting the Footrest

Lift the footrest and it will click into the highest position. To release, press both buttons simultaneously and lower.

1

**Note:** Do not put downward pressure on the footrest until the buttons are completely depressed or it will feel stuck and not move.

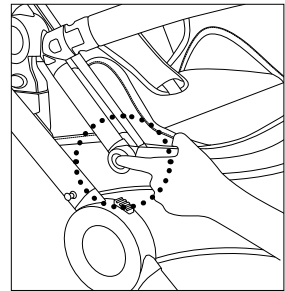

## **⚠️ WARNING**

NEVER LET CHILDREN SIT ON THE FOOTREST OR CLIMB INTO THE SEAT USING THE FOOTREST. DOING SO MAY TIP THE STROLLER, SNAP OR DAMAGE THE FOOTREST.

# USING YOUR DUO3

## Front Swivel Wheels

When travelling quickly along straight surfaces or across uneven terrain, the front wheels may spin or cause what's commonly known as "wheel shudder". Lock the wheels to avoid this.

**1** To lock the wheels, press down on the buttons, located on the back of the wheel sockets. To go back to 360° swivel mode press the buttons up again.

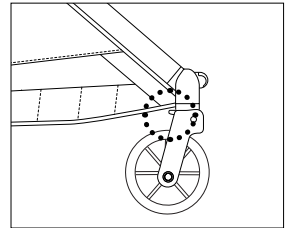

**2** To remove the wheels you will need to use a flat screw driver or similar tool to carefully press in the silver button located on the wheel hub. Please take care whilst doing this. Whilst pressing the button, pull the wheel out.

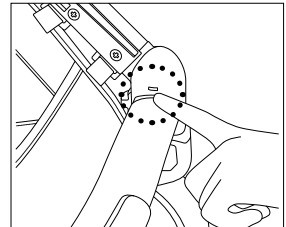

## Rear Wheels

**1** To remove the rear wheels, press the button located on the brake bar and pull the wheel off.

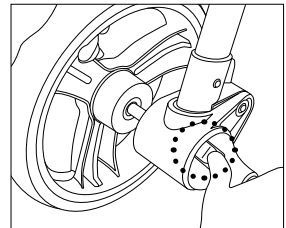

# USING YOUR DUO3

## Adjusting the handlebar

Push the button in the middle of the handlebar and pull or push to your desired height. It may require a slight "jiggle" to adjust.

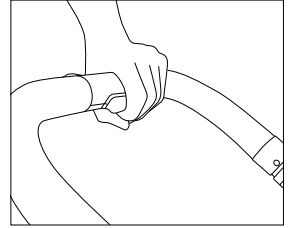

## **⚠** WARNING

- USE THE TETHER STRAP TO STOP THE STROLLER ROLLING AWAY.
- DO NOT HANG ANY OTHER BAGS OTHER THAN THE DUO3 HANDLEBAR BAG FROM THE HANDLEBAR. DOING SO MAY UNBALANCE AND TIP YOUR STROLLER.
- THE DUO3 HANDLEBAR BAG HAS BEEN TESTED TO HOLD 2KG.
- BE CAREFUL CARRYING LIQUIDS IN THE HANDLEBAR BAG. HOT LIQUIDS MAY BURN YOU OR YOUR CHILD.

# ACCESSORIES

## Rain covers

The rain covers are compatible with both seat and bassinet. Place them over the top. The open flap should be at the top, this is to access the bassinet handle.

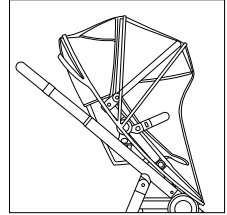
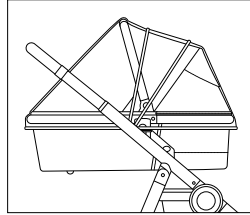

## UV/Mosquito/Sleep Cover

The cover is located in the zipped pocket under the footrest. Place it over the canopy and attach the elastic loops to the back of the canopy connectors and then tuck it under the footrest.

**Note:** Compatible with seat only.

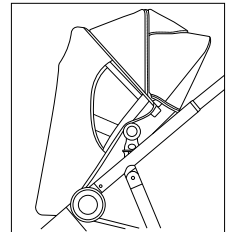

## ⚠ WARNING

NEVER LEAVE RAIN COVERS OR UV COVERS ON OR OVER THE STROLLER INDOORS, IN A HOT ATMOSPHERE OR NEAR A HEAT SOURCE. ALWAYS SUPERVISE WHILST THE STROLLER IS COVERED.

## Handlebar bag

Secure the straps to both sides of the handlebar using the Velcro.

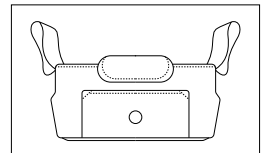

## Toddler Board

The DUO3 is compatible with the Babybee toddler board (sold separately). The maximum weight of a child on the toddler board is 20kg.

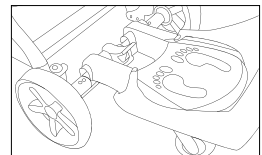

# USING YOUR DUO3 WITH A CAR CAPSULE

The following car capsules are compatible with the DUO3 Capsule Adaptors (sold separately). The list of compatible car capsules changes regularly as new capsule models are released or older versions are updated and launched to market. Please refer to our website for the most up to date compatibility list.

**Please ensure you choose the correct capsule adaptors to fit your pram.**

- Maxi Cosi Citi\*
  - Maxi Cosi Mico Plus
  - Maxi Cosi Mico 6
  - Maxi Cosi Mico AP\*\*
  - Maxi Cosi Mico\*\*\*
  - Maxi Cosi Mico 12 / Mico 12 LX\*\*\*\*
  - Joie Gemm
  - Joie i-Gemm
  - Joie i-Gemm Signature
  - Cybex Cloud Q
  - Nuna Pipa Klik
  - Nuna KLIK Plus
  - Bugaboo Turtle by Nuna
  - Mother's Choice Baby Capsule
  - Britax B-Pod
  - Britax B-Pod Lite
- \* With adaptors purchased after 14/1/2022
- \*\* Manufactured in 2014 or later
- \*\*\* Manufactured in 2013 or later
- \*\*\*\* From manufacture date 18/04/2023

## To attach:

1

Apply the brake before attaching the adaptors to the corresponding connector points on both sides of the stroller frame.

2

Lift your capsule and carefully lower onto the adaptors until you hear a click. This indicates your capsule is now secured to your stroller.

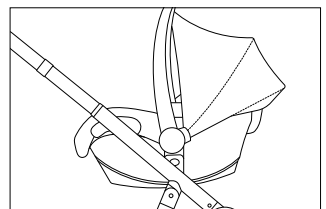
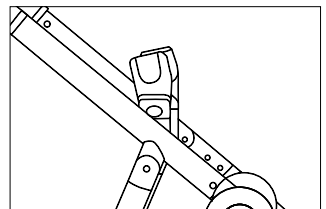

## USING YOUR DUO3 WITH A CAR CAPSULE

### To remove:

- 1 Apply the brake then simultaneously press the release buttons on each side **of the capsule** and lift the capsule off the adaptors.

**Note:** Each capsule may have slightly different buttons to release the car capsule from the adaptors.

- 2 To remove the adaptors from the stroller frame, push the release buttons on either side.

### **WARNING**

- FOLLOW THE CAPSULE MANUFACTURER'S INSTRUCTIONS CAREFULLY TO PREVENT INJURY OR EVEN DEATH.
- READ CAPSULE MANUFACTURER'S MAXIMUM USAGE TIME RECOMMENDED FOR BABY TO REMAIN IN YOUR SPECIFIC CAPSULE.
- DO NOT USE ANY CAPSULE NOT AUTHORISED BY BABYBEE.
- ENSURE ALL FINGERS AND BODY PARTS ARE CLEAR OF THE CAPSULE AND STROLLER FRAME WHEN ATTACHING.
- NEVER PLACE THE CAPSULE IN THE CAR WHILE ADAPTORS ARE ATTACHED.

# KEEPING YOUR DUO3 IN TIP-TOP SHAPE

Excessive wear can reduce the effectiveness and safety of your stroller. To keep your stroller in good working condition and ensure that it lasts as long as possible will require regular maintenance.

## Regular maintenance should include:

- Inspecting the locking devices, levers, joints, buttons, brakes, wheels, safety harness & fixtures to ensure they are secure, moving freely and in full working order.
- If any parts of the stroller have become stiff, difficult to operate or begin to squeak, first ensure that dirt is not the cause. Then try a light application of a sprayable silicone lubricant, ensuring that it penetrates between the components. **Note:** Silicone lubricant is preferable.

## **WARNING**

### **POISONOUS, TOXIC SUBSTANCE. USE WITH CARE.**

- ENSURE CHILDREN ARE NOT PRESENT WHEN APPLYING SILICONE LUBRICANT OR ALLOWING IT TO DRY.
- ALWAYS SPRAY OUTSIDE OR IN A WELL VENTILATED AREA.
- ENSURE YOU USE MINIMAL PRODUCT AND WIPE AWAY EXCESS SOLUTION BEFORE USE.

## Correct storage

- Do not leave the stroller in direct sunlight for prolonged periods of time to avoid colour fade.
- Do not leave DUO3 in your car on hot days or near any heat source or fire.
- Do not store the stroller with heavy items on top of it.
- Store the stroller in a dry, well-ventilated and safe place.



# KEEPING YOUR DUO3 IN TIP-TOP SHAPE

## Preventing rust & mould

- After exposure to wet or damp conditions, leave the stroller fully open in a warm, well-ventilated environment.
- You may need to dry with a soft lint-free cloth. Left damp it will encourage mildew, mould, or rust to form, causing damage to the stroller.
- Try to store your stroller in a dry, well-ventilated room inside your house. Ventilation is key.

**Note:** mould is an environmental issue caused by excess moisture in the air. If you live in a humid climate, please keep this in mind and take extra care to prevent mould.

## Cleaning instructions

To keep your stroller looking and functioning like new, we recommend a deep, comprehensive clean every 6 months.

Refer to the care labels on your stroller. For a full guide on how to clean your pram, please refer to our website.

## Do Not

- Do not immerse the seat or canopy in water, wipe clean only.
- Do not press or iron.
- Do not rub or wring fabric.
- Do not tumble dry.
- Do not clean with abrasive materials or using ammonia, bleach, solvents, caustic or spirit-based cleaners.
- Do not dry clean.

**Failing to adhere to these maintenance and cleaning instructions could damage or effect the safety of your stroller and may void your warranty.**

# WARRANTY INFORMATION

**Your DUO3 stroller comes with a 3 year defects warranty to cover against faults in materials and workmanship when your stroller is used under normal conditions, according to our user manuals and technical specifications.**

The benefits under our warranty are in addition to other rights & remedies under the law in relation to consumer goods: Our goods come with guarantees that cannot be excluded under Consumer Law in the country of purchase. You are entitled to a replacement or refund for a major failure and for compensation for any other reasonably foreseeable loss or damage. You are also entitled to have the goods repaired or replaced if the goods fail to be of acceptable quality and the failure does not amount to a major failure.

The warranty period starts from the date that your stroller is dispatched from our warehouse and is valid in the country of purchase only.

To make a claim email us at:  
**[au.support@babybeeonline.com](mailto:au.support@babybeeonline.com)** or  
**[nz.support@babybeeonline.com](mailto:nz.support@babybeeonline.com)**

Babybee reserves the right to repair, exchange or replace the damaged item with a replacement part.

**The warranty is not valid in the following cases:**

- Defects or faults resulting from improper assembly, care, or use as outlined in our user manual.
- Defects or faults resulting from an accident, airline or transport damage.
- Normal wear and tear, including scratches to the frame or colour fading of the fabrics.
- Corrosion, mould or rust due to extreme environmental conditions, including high humidity, or due to lack of regular maintenance.
- Products that are purchased secondhand or from an unauthorised distributor.
- Using a part or accessory that is not approved for use by Babybee.
- Claims from anyone other than the original purchaser (i.e. no longer valid if gifted or sold to another individual).
- Damage resulting from extreme heat conditions (i.e leaving in car on hot days).

ENJOY THE RIDE!

*team babybee*

Designer Style. Unbeatable Value.



---

MODEL: BABYBEE DUO3

VERSION: 17 JAN 2024

*Slight variations in the design of your stroller to the images shown in this manual may be present. Most recent versions can be found on our website.*

---

**[babybeonline.com](http://babybeonline.com)**