



ROVER3 BASSINET & STROLLER SET

PRODUCT MANUAL

**IMPORTANT! READ CAREFULLY
AND KEEP FOR FUTURE REFERENCE**

The Babybee ROVER3 is designed and tested to comply with:
Consumer Protection Notice No. 8 of 2007, AS 2088:2022 & AS/NZS ISO 8124-3

THANK YOU FOR CHOOSING BABYBEE!

Since 2015, we've been on a mission to make the very best baby products that make #parentlife better. Less stressful, more stylish, and more fun.

Welcome to the family!



CONTENTS

- 5.** Safety warnings
- 7.** What's in the box?
- 9.** Setting up your frame
- 10.** Setting up your bassinet
- 13.** Setting up your seat
- 15.** Using your harness
- 16.** Folding your ROVER3
- 17.** Using your ROVER3
- 17.** Rear brake
- 17.** Adjusting the footrest
- 18.** Front swivel wheels
- 18.** Rear wheels
- 18.** Reclining the seat
- 19.** Adjusting the handlebar
- 20.** Accessories
- 22.** Using your ROVER3 with a car capsule
- 24.** Keeping your ROVER3 in tip-top shape
- 26.** Warranty information

Read all instructions before assembling and using the product

SAFETY FIRST

WARNING

- FOLLOW THE MANUFACTURER'S INSTRUCTIONS.
- PUT ON ALL THE BRAKES WHENEVER YOU PARK THE STROLLER.
- DO NOT LEAVE CHILDREN UNATTENDED.
- DO NOT CARRY EXTRA BAGS ON THIS STROLLER.
- MAKE SURE CHILDREN ARE CLEAR OF ANY MOVING PARTS IF YOU ADJUST THE STROLLER OTHERWISE THEY MAY BE INJURED.

Maximum weight limits

- Maximum weight for a child in the seat is 20kg.
- Maximum weight for a child in the bassinet is 9kg.
- Maximum weight for items in the basket is 8kg.
- Maximum weight for items in the handlebar bag is 2kg.
- Maximum weight for the seat pocket is 1kg.

SAFETY FIRST

- Do not use parts or accessories that are not approved for use with the Babybee ROVER range. Doing so may be unsafe and may also void your warranty.
- Do not lift or carry the stroller when occupied by your child.
- This is not a toy. Do not allow your child to climb, stand on or play with the stroller.
- Do not use the stroller in a manner for which it is not designed.
- Only to be used for walking. Not suitable for running, rollerblading or skating etc.
- Remove your child and fold the stroller when going up or down stairs or escalators.
- Take your child out of the stroller when travelling by bus, tram or train.
- Gentle sloping surfaces may be unstable. On steeper sloping and uneven surfaces, there is a possibility that the stroller may tip over and you may need to remove your child.
- Do not use if any part is broken, torn or missing. Replacement parts are available from our website or by contacting us.
- Do not use or leave the stroller near open fire or exposed flame.
- Do not overload the stroller with additional children, bags or other items.
- Do not allow children to stand on the axle/brake bar between the wheels. This is unsafe and could damage the stroller.
- If the stroller is being used by someone unfamiliar with it (such as grandparents) always explain to them how the stroller works and its safety features.

WHAT'S IN THE BOX?

Please check that you have all the correct parts before getting started.

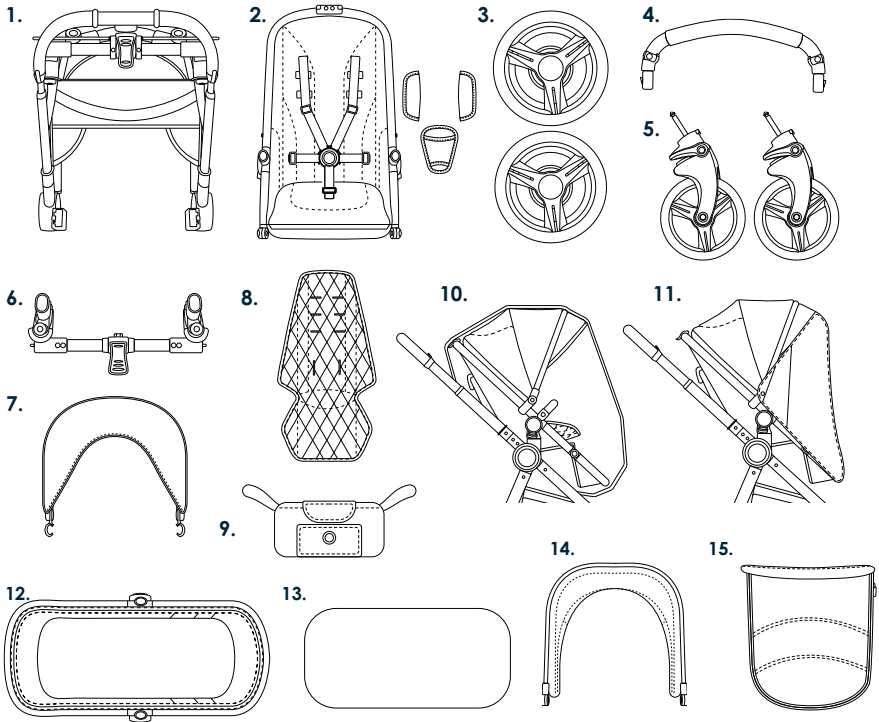

- | | | |
|----------------------------|---|---------------------------------|
| 1. Frame & basket | 8. Seat liner | 13. Bassinet mattress and liner |
| 2. Seat & harness covers | 9. Handlebar bag | 14. Bassinet canopy |
| 3. 2 x rear wheels | 10. Rain cover (fits seat and bassinet) | 15. Bassinet cover |
| 4. Belly bar | 11. UV/Sleep Cover | |
| 5. 2 x front swivel wheels | 12. Bassinet | |
| 6. Brake bar | | |
| 7. Seat Canopy | | |

SETTING UP YOUR FRAME

1 To unlock the frame, press the black button on the right frame release lever, and pull both release levers back towards the handlebar.

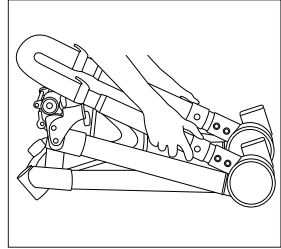

2 To open, lift up and swing the lower section into place ensuring you hear it "click" into place.

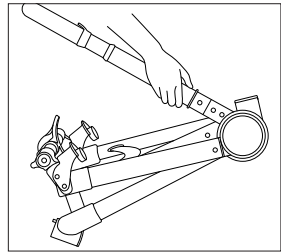

3 Attach the brake bar to the rear of the frame. Push until you see the silver locking pins click into place.

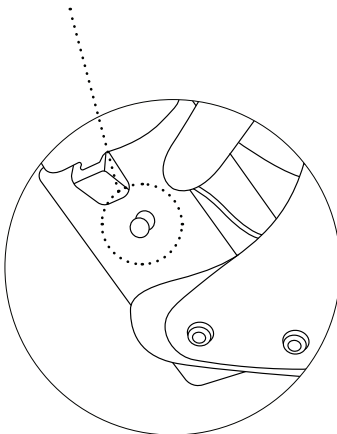
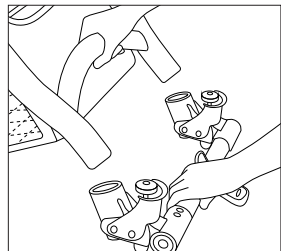

SETTING UP YOUR FRAME

4

Insert each rear wheel pin into the sides of the brake bar until you hear a 'click'. Give them a tug to ensure they are attached securely.

5

Insert each front wheel pin into the centre of the socket ensuring you hear them 'click' in. Give them a tug to ensure they are attached securely.

Your frame is now set up!

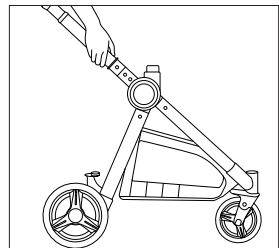
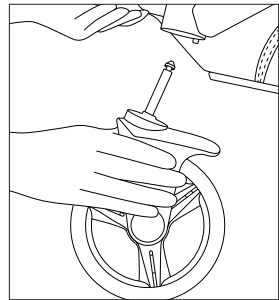
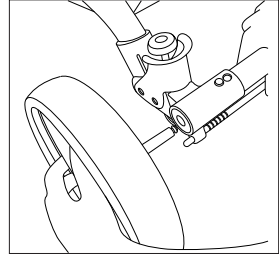

SETTING UP YOUR BASSINET

Setting up the base

- 1 Using the fabric straps, pull the frame support rods towards the ends of the bassinet until they lock under the plastic clips.
- 2 Zip the bassinet fabric onto the frame as shown.
- 3 Insert the bassinet mattress.

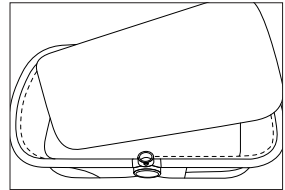
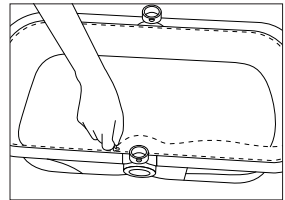
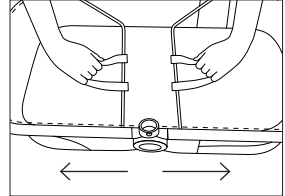

Attaching the canopy

- 1 Starting from the left side of the bassinet, zip the canopy onto the frame. (**Tip:** the canopy end is the end with the thick zip)
- 2 Attach the plastic connectors onto the frame. The connectors attach over the round guides on the frame. (**Tip:** first attach the top half then press the bottom panel into place)

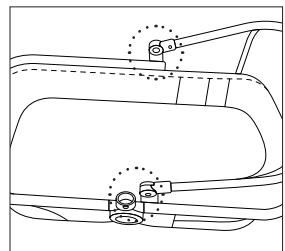
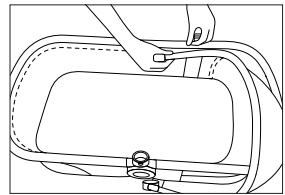

SETTING UP YOUR BASSINET

Attaching the cover & belly bar

- 1 Starting from the right side when standing at the foot end of the bassinet, zip the foot cover onto the opposite end to the canopy.

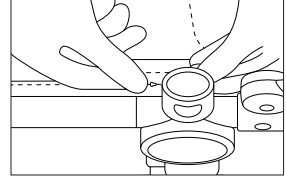

- 2 Using the belly bar from your stroller seat, insert it into the sockets. Always give the bar a firm tug to ensure it's secure. To remove from one side or both, press the button on the side you want to release and pull the belly bar out.

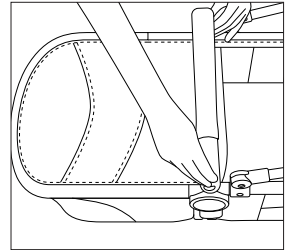

NOTE: To reduce the risk of SIDS, paediatricians recommend healthy infants be placed on their backs to sleep, unless otherwise advised by your physician.

⚠ WARNING

- DO NOT USE THIS BASSINET ONCE THE CHILD CAN SIT UP UNAIDED.
- DO NOT USE FOR UNSUPERVISED SLEEPING.
- DO NOT ADD AN ADDITIONAL MATTRESS OR PADDING INSIDE THE BASSINET.
- THE BASSINET IS NOT DESIGNED TO BE CARRIED BY THE BELLY BAR WITH YOUR CHILD INSIDE.

USING YOUR BASSINET

Attaching & releasing the bassinet to the frame

Attach the bassinet onto the central connectors of the frame.

To release, lift the bassinet release buttons upwards and lift the bassinet up. The bassinet can face either direction.

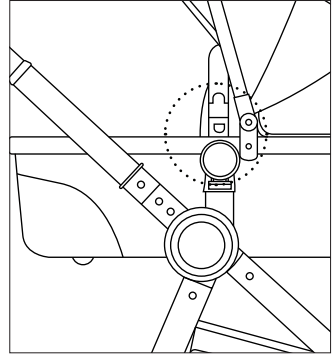

Using the ventilation panel

The head end of the bassinet fabric can be unzipped to expose a mesh panel, allowing additional air flow.

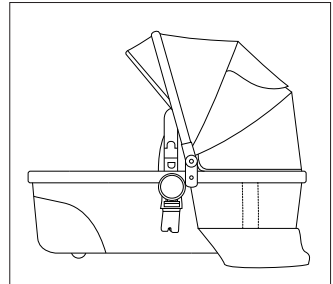

Using the sun visor

The bassinet has an inbuilt sun visor. Please be gentle when pulling this out to avoid the rod weakening over time.

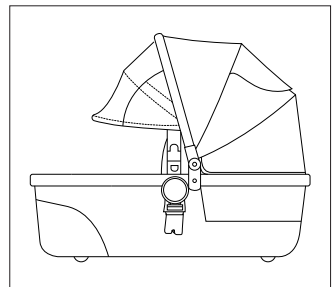

SETTING UP YOUR SEAT

1 Line up the seat connectors with the frame and press downwards. Listen for the 'click' and ensure it is securely locked in place.

2 To recline the seat, lift the seat recline latch located at the canopy end of the seat and tilt the seat forward or back.

Note: The seat can be faced in the forward or rear facing position.

3 To attach the canopy, secure it to the frame with the zip starting from the left side (when facing the seat).

4 Attach the plastic canopy connectors onto the sides of the frame (**Tip:** attach from top to bottom). The connectors should attach over the round guides on the frame.

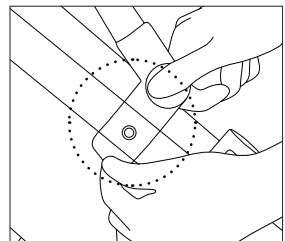
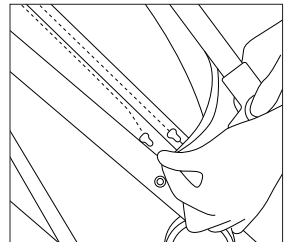
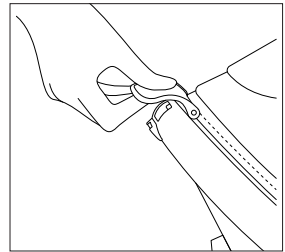
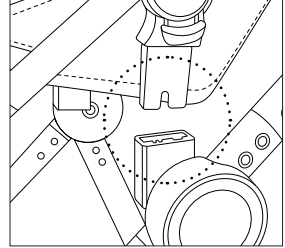

SETTING UP YOUR SEAT

5

Insert the belly bar into the belly bar sockets on the seat frame. Always give the bar a firm tug to ensure it's secure.

To remove from one side or both, press the button on the side you want to release, and pull the belly bar out.

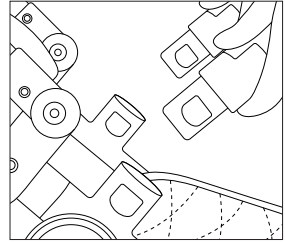

! WARNING

- THE STROLLER SEATS ARE NOT RECOMMENDED FOR CHILDREN UNDER 6 MONTHS.
- THIS STROLLER SEATS ONE PASSENGER WITH A MAXIMUM WEIGHT LIMIT OF 20KG.
- DO NOT ALLOW YOUR CHILD TO CLIMB UNASSISTED INTO THE STROLLER.

USING YOUR HARNESS

To secure and release the harness

Insert each of the 4 harness straps into the central buckle.

To release, press the button in the middle of the buckle.

To adjust the length of the shoulder straps

Slide the buckle along the strap to the desired position.

To adjust the height of the shoulder straps

Thread the strap through the correct loop on the seat and then through the corresponding slot on the seat liner.

To adjust the length of the waist straps

Pull the adjustor buckle along the waist strap to the desired length.

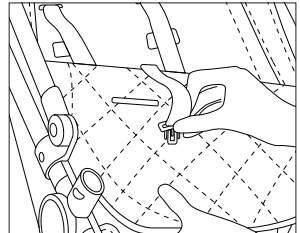
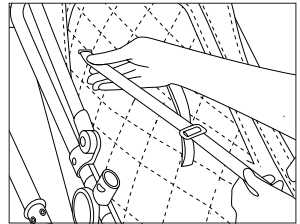
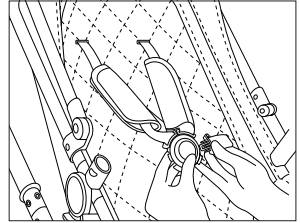

⚠ WARNING

- SECURE THE CHILD IN THE HARNESS AT ALL TIMES.
- ENSURE THAT YOUR CHILD CORRECTLY WEARS THE FITTED AND ADJUSTED SAFETY HARNESS AT ALL TIMES WITH ALL 5 STRAPS SECURED.
- NEVER LEAVE THE HARNESS BUCKLED WHEN NOT FITTED TO A CHILD IN THE STROLLER BECAUSE THE HARNESS CAN FORM LOOPS WHICH MAY POSE A STRANGULATION HAZARD.

FOLDING YOUR ROVER3

- 1 Before folding, ensure that the brake is engaged and the front wheels are unlocked.
 - 2 Remove the stroller seat by lifting the release levers on either side.
 - 3 Push the black button on the frame release lever and then pull both black release levers up the frame.
 - 4 Push down on the handlebar to close it.
- Ensure the automatic frame lock has engaged on the side of the stroller before lifting it up using the carry bar and the front wheels will close inwards.

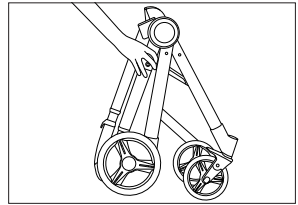
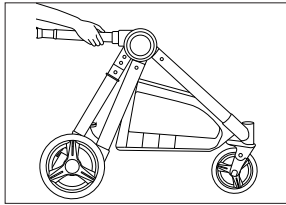
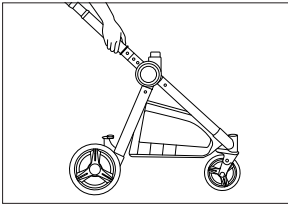

⚠ WARNING

- ENSURE CHILDREN ARE OUT OF REACH OF THE STROLLER BEFORE FOLDING.
- TAKE EXTRA CARE WHEN FOLDING, LIFTING, AND CARRYING THE STROLLER. ALWAYS LIFT AND CARRY YOUR STROLLER USING BOTH HANDS.
- TO AVOID POSSIBLE INJURY, ALWAYS ENSURE THAT THE FRAME LOCK IS SECURED BEFORE LIFTING AND CARRYING THE STROLLER.
- TO AVOID FINGER ENTRAPMENT, KEEP YOUR OWN AND YOUR CHILDREN'S FINGERS CLEAR OF ANY FOLDING PARTS.
- ALWAYS REMOVE THE CAR CAPSULE, BASSINET OR SECOND SEAT PRIOR TO FOLDING AND CARRY THE FRAME AND SEAT/BASSINET SEPARATELY. ONLY LIFT AND CARRY THE STROLLER AFTER FOLDING.

USING YOUR ROVER3

Rear Brake

1 When stopped, use the brake at all times by pressing down on the bottom of the red brake paddle with your foot until you feel it click into place.

2 To start travelling again press down on the top of the red brake paddle with your foot to disengage the brake and off you go!

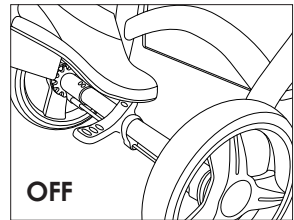
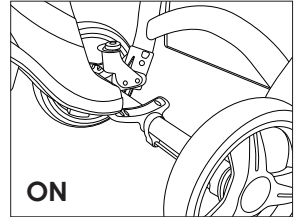

Adjusting the Footrest

1 Press both footrest buttons simultaneously and adjust the footrest to the desired position.

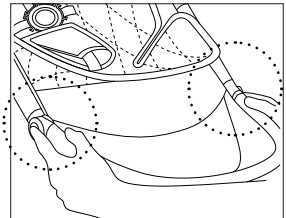

⚠ WARNING

NEVER LET CHILDREN SIT ON THE FOOTREST OR CLIMB INTO THE SEAT USING THE FOOTREST. DOING SO MAY TIP THE STROLLER, SNAP OR DAMAGE THE FOOTREST.

USING YOUR ROVER3

Front Swivel Wheels

When travelling quickly along straight surfaces or across uneven terrain, the front wheels may spin or cause what's commonly known as "wheel shudder". Lock the wheels to avoid this.

- 1 To lock the wheels, press down on the buttons, located on the top of the wheel sockets. To go back to 360° swivel mode press the buttons again.
- 2 To remove the front wheels, press the button on the side of the wheel socket and pull the wheel down.

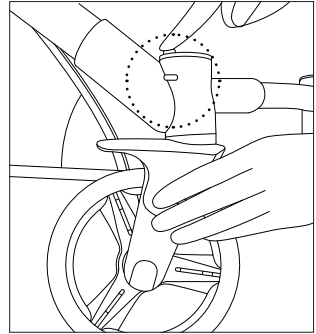

Rear Wheels

- 1 To remove the rear wheels, press the button located on the brake bar and pull the wheel off.

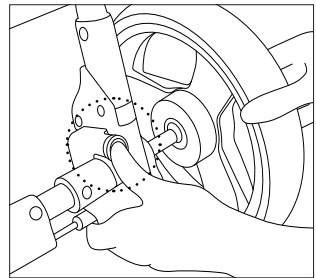

Reclining the Seat

The seat can recline to 4 set positions. Fully lift the seat recline latch (located at the top of the canopy) and recline the seat to the desired position.

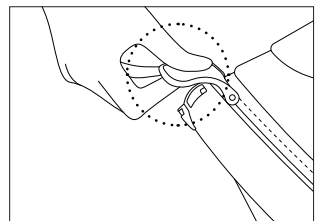

USING YOUR ROVER3

Adjusting the Handlebar

Push the button in the middle of the handlebar and pull or push to your desired height.

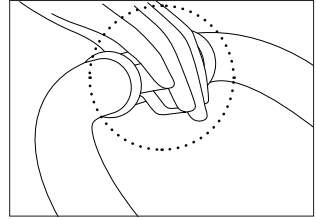

⚠ WARNING

- USE THE TETHER STRAP TO STOP THE STROLLER ROLLING AWAY.
- DO NOT HANG ANY OTHER BAGS OTHER THAN THE ROVER3 HANDLEBAR BAG FROM THE HANDLEBAR. DOING SO MAY UNBALANCE AND TIP YOUR STROLLER.
- THE ROVER3 HANDLEBAR BAG HAS BEEN TESTED TO HOLD 2KG.
- BE CAREFUL CARRYING LIQUIDS IN THE HANDLEBAR BAG. HOT LIQUIDS MAY BURN YOU OR YOUR CHILD.

ACCESSORIES

Rain cover (compatible with seat and bassinet)

Pull the rain cover and elastic over the top of the canopy and then over the end of the seat/bassinet. Please ensure the air vents are located on either side so that air can pass through.

Note: The cover will be looser on the bassinet due to its shorter frame and canopy.

UV/Mosquito/Sleep Cover

Fully extend the canopy. Secure the buttonhole on both sides of the cover over the canopy connector, then hook the cover over the base of the seat and top of the canopy.

Note: Compatible with seat only.

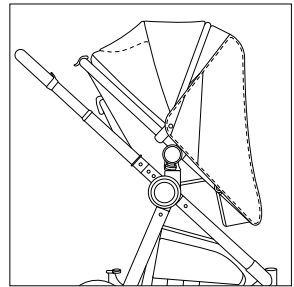
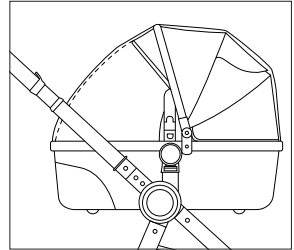
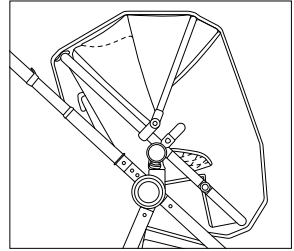

⚠ WARNING

NEVER LEAVE RAIN COVERS OR UV COVERS ON OR OVER THE STROLLER INDOORS, IN A HOT ATMOSPHERE OR NEAR A HEAT SOURCE. ALWAYS SUPERVISE WHILST THE STROLLER IS COVERED.

ACCESSORIES

Handlebar Bag

Secure the straps to both sides of the handlebar using the Velcro. The handlebar bag must be installed & positioned behind the hooks on the handlebar.

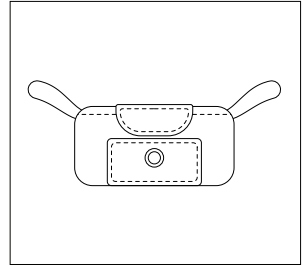

Seat Liner

Attach the seat liner by threading the harness straps from the seat through the corresponding slot.

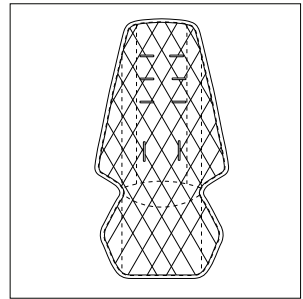

Toddler Board

The ROVER3 is compatible with the Babybee toddler board (sold separately). The maximum weight of a child on the toddler board is 20kg.

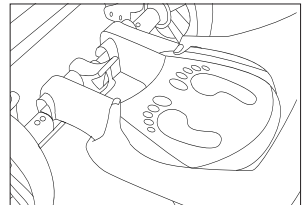

USING YOUR ROVER3 WITH A CAR CAPSULE

The following car capsules are compatible with the ROVER3 Capsule Adaptors (sold separately). See our website for the most recent compatibility list.

- Maxi Cosi Citi
- Maxi Cosi Titan
- Maxi Cosi Mico Plus
- Maxi Cosi Mico
(manufactured from 2014 onwards)
- Maxi Cosi Mico AP
(manufactured from 2013 onwards)
- Joie Gemm
- Joie i-Gemm
- Cybex Cloud Q
- Nuna KLIK Plus

To attach:

- 1 Apply the brake before attaching the adaptors to the corresponding connector points on both sides of the stroller frame.

- 2 Lift your capsule and carefully lower onto the adaptors until you hear a click. This indicates your capsule is now secured to your stroller.

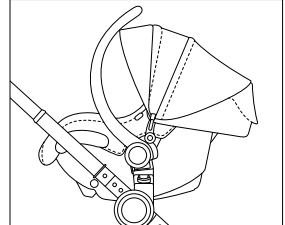
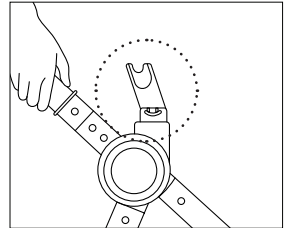

To remove:

- 1 Apply the brake and simultaneously press the release buttons on each side **of the capsule** and lift the capsule off the adaptors.
Note: Each capsule may have slightly different buttons to release the car capsule from the adaptors.

- 2 To remove the adaptors from the stroller frame, push the release buttons on either side.

USING YOUR ROVER3 WITH A CAR CAPSULE

! WARNING

- FOLLOW THE CAPSULE MANUFACTURER'S INSTRUCTIONS CAREFULLY TO PREVENT INJURY OR EVEN DEATH.
- READ CAPSULE MANUFACTURER'S MAXIMUM USAGE TIME RECOMMENDED FOR BABY TO REMAIN IN YOUR SPECIFIC CAPSULE.
- DO NOT USE ANY CAPSULE NOT AUTHORISED BY BABYBEE.
- ENSURE ALL FINGERS AND BODY PARTS ARE CLEAR OF THE CAPSULE AND STROLLER FRAME WHEN ATTACHING.
- NEVER PLACE THE CAPSULE IN THE CAR WHILE ADAPTORS ARE ATTACHED.

KEEPING YOUR ROVER3 IN TIP-TOP SHAPE

Excessive wear can reduce the effectiveness and safety of your stroller. To keep your stroller in good working condition and ensure that it lasts as long as possible will require regular maintenance.

Regular maintenance should include:

- Inspecting the locking devices, levers, joints, buttons, brakes, wheels, safety harness & fixtures to ensure they are secure, moving freely and in full working order.
- If any parts of the stroller have become stiff, difficult to operate or begin to squeak, first ensure that dirt is not the cause. Then try a light application of a sprayable silicone lubricant, ensuring that it penetrates between the components. **Note:** Silicone lubricant is preferable.

WARNING

POISONOUS, TOXIC SUBSTANCE. USE WITH CARE.

- ENSURE CHILDREN ARE NOT PRESENT WHEN APPLYING SILICONE LUBRICANT OR ALLOWING IT TO DRY.
- ALWAYS SPRAY OUTSIDE OR IN A WELL VENTILATED AREA.
- ENSURE YOU USE MINIMAL PRODUCT AND WIPE AWAY EXCESS SOLUTION BEFORE USE.

Correct storage

- Do not leave the stroller in direct sunlight for prolonged periods of time to avoid colour fade.
- Do not leave ROVER3 in your car on hot days or near any heat source or fire.
- Do not store the stroller with heavy items on top of it.
- Store the stroller in a dry, well-ventilated and safe place.

KEEPING YOUR ROVER3 IN TIP-TOP SHAPE

Preventing rust & mould

- After exposure to wet or damp conditions, leave the stroller fully open in a warm, well-ventilated environment.
- You may need to dry with a soft lint-free cloth. Left damp it will encourage mildew, mould, or rust to form, causing damage to the stroller.
- Try to store your stroller in a dry, well-ventilated room inside your house. Ventilation is key.

Note: mould is an environmental issue caused by excess moisture in the air. If you live in a humid climate, please keep this in mind and take extra care to prevent mould.

Cleaning instructions

To keep your stroller looking and functioning like new, we recommend a deep, comprehensive clean every 6 months.

Refer to the care labels on your stroller. For a full guide on how to clean your pram, please refer to our website.

Do Not

- Do not immerse the seat or canopy in water, wipe clean only.
- Do not press or iron.
- Do not rub or wring fabric.
- Do not tumble dry.
- Do not clean with abrasive materials or using ammonia, bleach, solvents, caustic or spirit-based cleaners.
- Do not dry clean.

Failing to adhere to these maintenance and cleaning instructions could damage or effect the safety of your stroller and may void your warranty.

WARRANTY INFORMATION

Your ROVER3 stroller comes with a 3 year defects warranty to cover against faults in materials and workmanship when your stroller is used under normal conditions, according to our user manuals and technical specifications.

The benefits under our warranty are in addition to other rights & remedies under the law in relation to consumer goods: Our goods come with guarantees that cannot be excluded under Consumer Law in the country of purchase. You are entitled to a replacement or refund for a major failure and for compensation for any other reasonably foreseeable loss or damage. You are also entitled to have the goods repaired or replaced if the goods fail to be of acceptable quality and the failure does not amount to a major failure.

The warranty period starts from the date that your stroller is dispatched from our warehouse and is valid in the country of purchase only.

To make a claim email us at:
au.support@babybeeonline.com or
nz.support@babybeeonline.com

Babybee reserves the right to repair, exchange or replace the damaged item with a replacement part.

The warranty is not valid in the following cases:

- Defects or faults resulting from improper assembly, care, or use as outlined in our user manual.
- Defects or faults resulting from an accident, airline or transport damage.
- Normal wear and tear, including scratches to the frame or colour fading of the fabrics.
- Corrosion, mould or rust due to extreme environmental conditions, including high humidity, or due to lack of regular maintenance.
- Products that are purchased secondhand or from an unauthorised distributor.
- Using a part or accessory that is not approved for use by Babybee.
- Claims from anyone other than the original purchaser (i.e. no longer valid if gifted or sold to another individual).
- Damage resulting from extreme heat conditions (i.e leaving in car on hot days).

ENJOY THE RIDE!

team babybee



MODEL: BABYBEE ROVER3 VERSION: 3 | JAN 2023

Slight variations in the design of your stroller to the images shown in this manual may be present. Most recent versions can be found on our website.

[babybeeonline.com](https://www.babybeeonline.com)