

# Oltre

Sofa & Sectional



# Oltre

## SPECS

### Side Detail

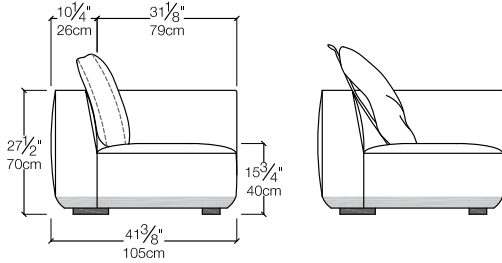

### Metal Backrest

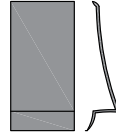

### Cushions

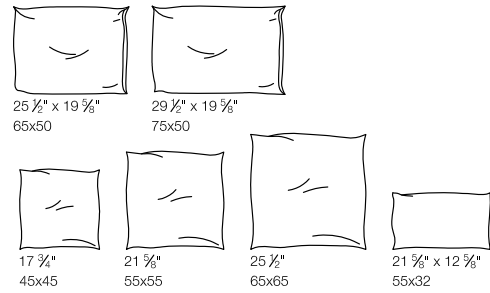

### Top View

Sofa - Available in 4 widths

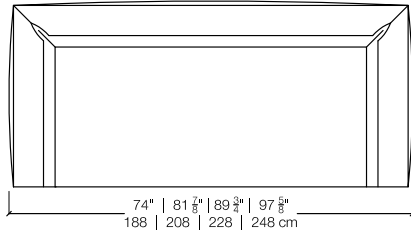

1 Arm Element / Ending chaise - Available in 5 widths and right versions

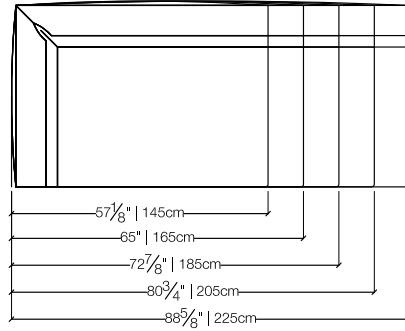

Center Element  
 Available in 2 widths

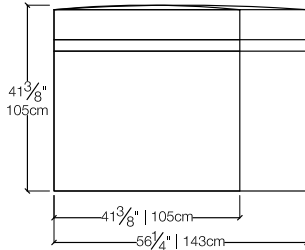

Ottoman 105

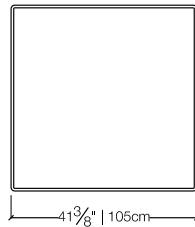

Ottoman - Available in 2 widths

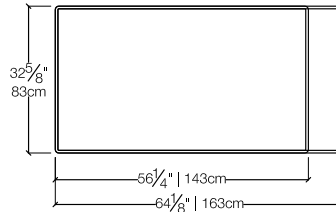

## FINISHES

Available in a variety of fabrics and leathers.  
 Fabric is completely removable, leather is fixed.