

---

# User Manual



Air Bone Conduction Headphones

## Summary of button functions

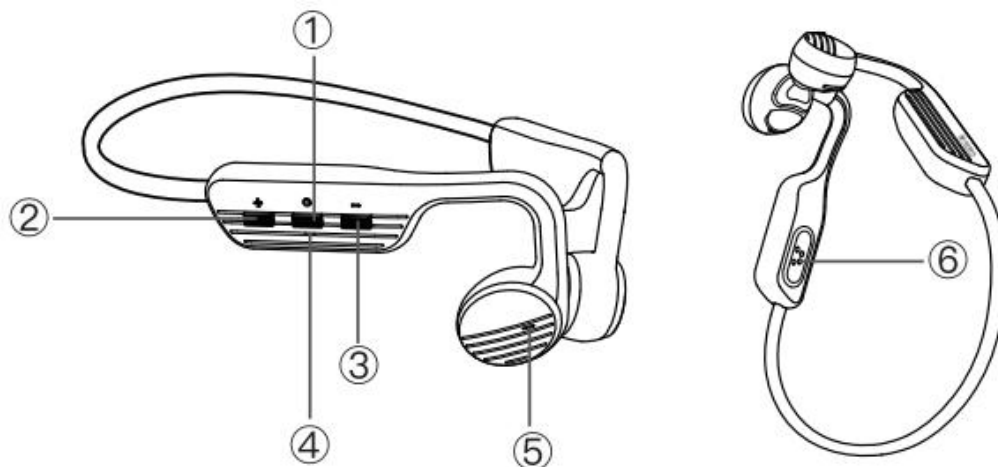

- 
- ① Multifunctional buttons: Power on/Power off/Pause/Play/  
Answer phone call/End phone call/Voice assistant
- ② Volume up(+)      ③ Volume down(-)      ④ LED indicator
- ⑤ Microphone      ⑥ Magnetic charging port
- 

## Packing list



Bone Conduction  
Headphones



Charging Cable



User Manual

## How to wear

Hang the headphone behind your neck with both speakers clinging to your cheekbones. After that, adjust it until you feel comfortable.

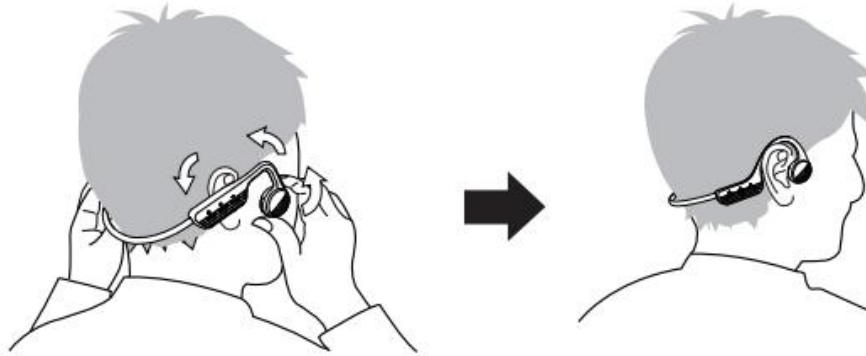

## Controls

### Power on

When the headphone is in a power-off status, press and holds the power button for 2 seconds with blue and red LED flickering alternately 3 times, reminding tone "Power on".

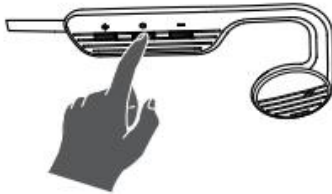

### Power off

When the headphone is in a power-on status, press and holds the power button for 2 seconds with red LED flickering 3 times, reminding tone "Power off".

## How to connect:

### When the headphone is off

- 1) Press and hold the power button for 2 seconds to turn on the headphone, the headphone will automatically pair and flash red and blue lights alternately.
- 2) Find the headphone name with “AC889” on the Bluetooth list, and click connect. After the connection is successful, the blue LED flickers with a reminding tone “Connected”.
- 3) When using the headphone again. Just turn on the headphone and it will be automatically connected with the Bluetooth device. (The last connected device)

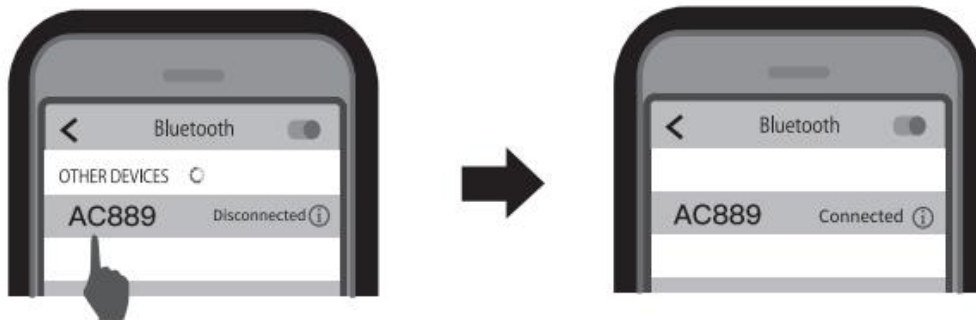

### How to connect other devices:

Disconnect the Bluetooth of the currently paired device, the headphone will flash red and blue lights alternately with reminding tone “Disconnected”. After that, find the headphone name “AC889” on another device’s Bluetooth list and click connect.

## Operating function

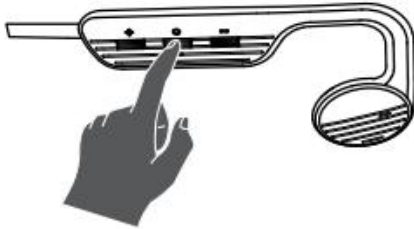

### Headset off state

Long press for 2 Seconds  
headphone power on.

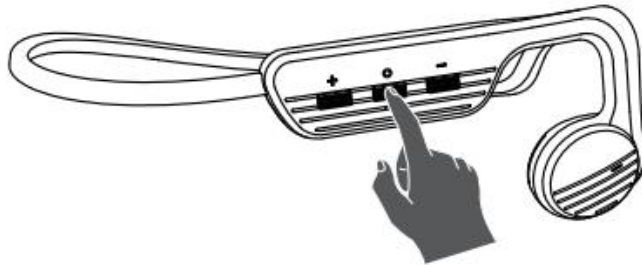

### Multi-function button

#### Play status

- Single-click to play/pause music.
- Double-click Switch to the memory card music or bluetooth mode.
- Triple-click to enter voice assistant mode.

#### Incoming call status

- Single-click to answer and hang up.

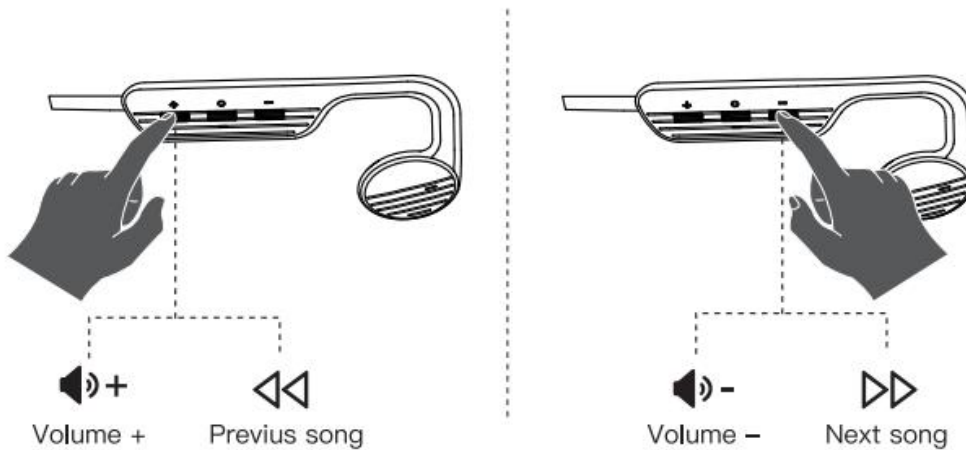

## Volume +/-

- Single click volume up(+) to turn the volume up.
- Single click Volume up(-) to turn the volume down.

## Previous song/Next song

- Long press volume up(+) to the next song.
- Long press volume down(-) to the previous song.

---

## Indicator light Instruction

- Red and blue light flickering: Paired
- Red light on: Charging
- Blue light on: Fully charged



## How to charge

When the headphone connects to the phone, the phone will display the battery level of the headphone. If the battery level is displayed in red, it means that it needs to be charged. Just plug in the USB charging cable to the USB charging port to charge.

## How to download or delete the songs

Connected the original charging data cable to the computer and headset, the computer will display U disk after 5 seconds, you can download or delete the songs on your computer.

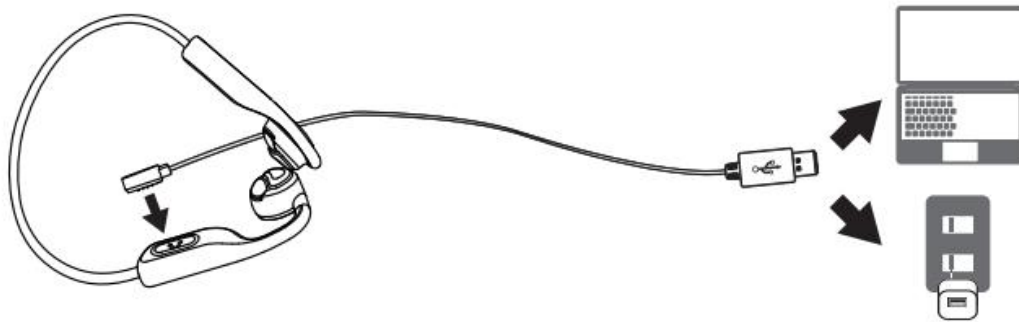

(※ **Note:** Please download music in HD lossless format for better sound quality experience.)

## Specifications

Product model	AC889
BT version	V5.2
Product weight	32.2g
Headphone battery	280mAh
Memory card	32G
Charging time	2.5 hours
Music play time	Around 24 hours
Speaker impedance	-42dB
Waterproof	IPX5
Connect distance	10 meters
Input	5V-1A
Support format	WAV/FLAC/MP3



## Attentions

- Please wear the headphones at your cheekbones before your ears and do not put them in your ears.
- Our headphones with built-in 32GB memory card, with two modes: Bluetooth mode and MP3 mode (local player)

Charging – Charge your headphones with the included magnetic charger.

Upload music – Please use the provided data cable USB port to connect to the computer and drag and drop the songs downloaded directly to the headphone memory card.

**Note:** Only supported media formats are MP3 and FLAC; Please convert other incompatible formats before downloading.

## Warning!

If there is any injury or property loss due to violation of the above contents, we will not bear any responsibility.

## Customer service

We provide all our customers a 365–days warranty from the date of purchase.

Any problem, please contact our after–sales for solutions.

- ① Open the Product Details Page → Find and Click Sold by “XXX” Store (Seller Name) → Click “Ask a question” to contact us.
- ② Open your Amazon Account → Click “Your Orders” → Find the problematic Order → Click “Get Help with Order” to Contact us.