

ISSUE 12
2023

metalcraft™

Accessories Booklet 2023

A comprehensive range
of items to adorn your
Metalcraft projects

JCR
WOOD

To see the full range visit our website:
www.metalcrafttools.com

Welcome to our Accessories Booklet

which showcases our full range of
existing decorative accessories and
sundry items

Don't forget that this booklet is an accompaniment to our What's New Catalogue (Issue 12) which features all of our newly introduced accessories for 2023 as well as all the latest developments in our Metalcraft tools and workshop packages, plus our packs of steel, fixings, and learning and teaching aids.

Together this booklet and our What's New Catalogue show the complete range of Metalcraft products and both can be downloaded for free in PDF format from our 'Free Stuff' page on our webstore (which you can see once you have successfully registered for a Login Account).

www.metalcrafttools.com

Alternatively, should you require one or both booklets sending by email or by post, contact us today on +44 (0)1482 345067 or at

info@jandcrwood.co.uk



Contents

| | |
|----------------------------------|-----|
| Candle Accessories | 04 |
| Easyfix Craft Accessories | 012 |
| Self Fix Craft Accessories | 014 |
| Decorative Features | 020 |
| Gate Hardware | 026 |
| Clock Components | 030 |
| Letters and Numbers | 038 |
| Back/Base Plates and Accessories | 039 |
| Connector Plates and Collars | 040 |
| Sundries Section | 042 |
| Gift Vouchers | 043 |
| How to Order | 044 |
| UK Order Form | 045 |

6 EASY WAYS TO BUY



Mail to: J & C R Wood Ltd
66 Clough Road, Hull HU5 1SR

Call our order line on: 01482 345067

Fax: 01482 441141

E-mail: sales@jandcrwood.co.uk

(unsecure – so it is advisable to request confirmation of order value to pay and on receipt of this contact us by phone to confirm credit/debit card details)

From our factory:

J & C R Wood Ltd
66 Clough Road, Hull
HU5 1SR

(for demonstrations or to collect orders please contact us well beforehand to check availability)

On-line store:

www.metalcrafttools.com

Candle Accessories

Our ever popular and impressive range of candle holders, drip trays, glassware and accessories create endless possibilities for candle and lighting related projects.





Please see overleaf for our current range of great looking candle accessories.

Candle Accessories

Metalwork and candles have complemented each other for centuries and remain as popular today as ever.

With our large range of candle accessories you can incorporate many types of candle into your designs.



W1, W1A and W1B can be combined to create a flower effect. Then with a touch of paint you can really bring it to life.

Candle Holders with Punched Hole

All of the holders in this section are designed to take the thinner style dinner candles. The holders are pre-punched with a central 3mm diameter hole to allow fixing to metalwork using our nut and bolt fixings.



Code MC068 W1 Candle Holder

30 Dia x 33 H x 1mm Thick
£1.46 ex VAT
£1.75 inc VAT



Code MC069 W1A Candle Holder

64 Dia x 21 H x 1mm Thick
£1.46 ex VAT
£1.75 inc VAT



Code MC070 W1B Candle Holder

78 Dia x 5 H x 1mm Thick
£1.46 ex VAT
£1.75 inc VAT

Chunky Candle Trays with Punched Hole

These can be used together with our candle holders as an extra decorative feature or can be used directly to stand much larger candles on. Also, the extra thickness and weight make them useful as bases or indeed connector plates (see page 41). All trays are pre-punched with a central 3mm diameter hole to allow fixing to metalwork using our nut and bolt fixings.



Code MC954 T40 Chunky 3" Candle Tray

76 Dia x 8 H x 2mm Thick
£0.91 ex VAT
£1.09 inc VAT



Code MC1160 T41 Chunky 4" Candle Tray

100 Dia x 10 H x 2mm Thick
£0.99 ex VAT
£1.19 inc VAT



Code MC955 T42 Chunky 5" Candle Tray

125 Dia x 12 H x 2mm Thick
£1.24 ex VAT
£1.49 inc VAT



Code MC956 T43 Chunky 6.5" Candle Tray

165 Dia x 16 H x 2mm Thick
£1.41 ex VAT
£1.69 inc VAT

All sizes stated are approximate and in mm

Candle Accessories

Candle Trays with Punched Hole

These candle trays can be used in conjunction with the candle holders as an extra decorative feature. Alternatively, they can be used directly to stand ball candles and church candles on.

Candle trays are pre-punched with a central 3mm diameter hole to allow fixing to metalwork using our nut and bolt fixings.



Code MC079
W15 Candle Tray
79 Dia x 8 H x 1mm Thick
£1.16 ex VAT
£1.39 inc VAT



Code MC715
C6 Candle Tray
65 Dia x 8 H x 1mm Thick
£0.91 ex VAT
£1.09 inc VAT



Code MC1412
T10 Candle Tray
63 Dia x 12 H x 1mm Thick
£1.74 ex VAT
£2.09 inc VAT



Code MC087
W25 Candle Tray
79 Dia x 8 H x 1mm Thick
£1.16 ex VAT
£1.39 inc VAT



Code MC088
W26 Candle Tray
63 Dia x 4 H x 1mm Thick
£0.91 ex VAT
£1.09 inc VAT

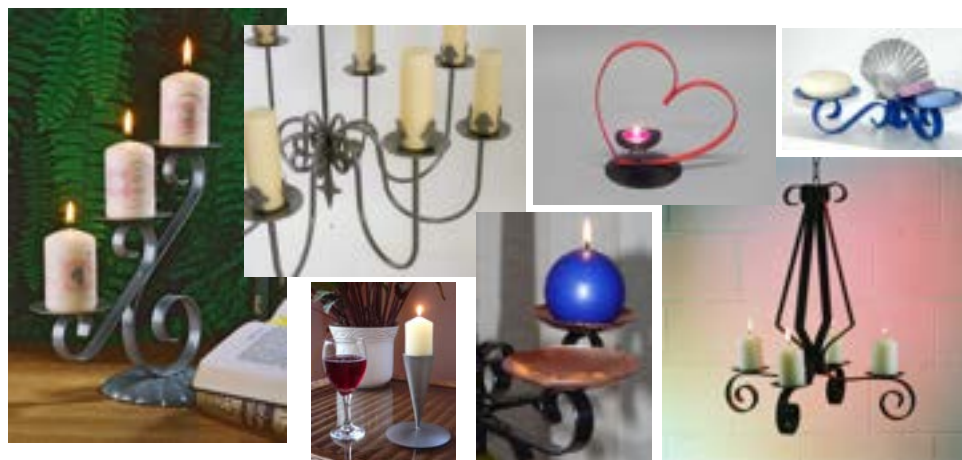

All sizes stated are approximate and in mm

Candle Accessories

Punched or Unpunched Trays and Holders (please specify when ordering)

These candle holders and trays are available with a central 3mm diameter hole pre-punched to allow fixing to metalwork using our nut and bolt fixings. However, for those wishing to weld or use the items where the hole is not required, we can provide these items unpunched.

When ordering make sure you state/select the version with the letter 'P' on the end if you want the item punched.

As you can see, these candle holders and trays offer a range of holders for a variety of candle sizes from tea lights to large church candles. Some of the items can also be used as bowls or bases too as shown in some of the images on pages 4 and 5.



Code MC1200
E1 Tealight Holder
 50 Dia x 20 H x 1mm Thick
£0.66 ex VAT £0.79 inc VAT
Punched MC1200P
£0.71 ex VAT £0.85 inc VAT



Code MC1201
E3 Sunburst Candle Tray
 85 Dia x 12 H x 1mm Thick
£1.66 ex VAT £1.99 inc VAT
Punched MC1201P
£1.79 ex VAT £2.15 inc VAT



Code MC1202
E4 Bottle Top Candle Tray
 45 Dia x 10 H x 1mm Thick
£1.08 ex VAT £1.29 inc VAT
Punched MC1202P
£1.21 ex VAT £1.45 inc VAT



Code MC1204
E6 Slim Tulip Candle Holder
 25 Dia x 26 H x 1mm Thick
£0.99 ex VAT £1.19 inc VAT
Punched MC1204P
£1.10 ex VAT £1.32 inc VAT



Code MC1205
E7 Fleur De Lys Candle Holder
 50 Dia x 50 H x 1mm Thick
£1.33 ex VAT £1.59 inc VAT
Punched MC1205P
£1.46 ex VAT £1.75 inc VAT



Code MC1206
E8 Bowl Candle Tray
 125 OD x 75 Base Dia x 35 H x 1mm Thick
£3.33 ex VAT £3.99 inc VAT
Punched MC1206P
£3.46 ex VAT £4.15 inc VAT



Code MC1207
E10 Flat Cone Tealight Holder
 84 OD x 48 Base Dia x 25 H x 1mm Thick
£2.33 ex VAT £2.79 inc VAT
Punched MC1207P
£2.38 ex VAT £2.85 inc VAT

All sizes stated are approximate and in mm

Candle Accessories

Miscellaneous Items

Here we can offer other items to incorporate in candle projects or possibly more general projects. Our LED Tealights are the safe alternative to real tealights.

Our cradles can complement some of the glassware on the following pages (for example MC1251, MC1250, MC1414, MC1416R on pages 10 and 11). The arms can be easily bent upwards to connect to chains to suspend the glassware as shown here.

Our Pot Saucer can be used as a leakproof drip tray for plant pots or candles and our small cone can be used as a weldable tealight/candle holder or as a decorative embellishment.



Code MC1268
Cradle for Mushroom Base Tealight Holders and Plain Sided Frosted Votive Holders

70 Outer Dia x 55 Inner Dia x 1mm Thick

£1.08 ex VAT

£1.29 inc VAT



Code MC1288
Small Cone

60 OD x 150 H x 2mm Thick

£2.49 ex VAT

£2.99 inc VAT



Code MC095

W33 Pot Saucer

87 Dia x 8 H x 1mm Thick

£1.66 ex VAT

£1.99 inc VAT

All sizes stated are approximate and in mm

Candle Accessories

Glassware

Glass candle holders are primarily designed for tealights but allow glassware to be added to metalwork projects in a variety of ways. Usually this is achieved by sitting them in metal rings rolled or bent by Metalcraft tools.

However, the Thistle Peg Glass is designed to fit in the narrow style candle holders and work well with our candle holders MC068 (as shown below), MC089 and MC1204P.



Code MC1250
Frosted Flowerpot Votive Glass

70 OD x 47 Base Dia x 60 H
x 6mm Thick

£2.49 ex VAT

£2.99 inc VAT



Code MC1414
Clear Flowerpot Votive Glass

70 OD x 47 Base Dia x 60 H
x 6mm Thick

£2.49 ex VAT

£2.99 inc VAT



Code MC1417
Glass Hurricane Lamp Chimney

64 Dia Base x 215 H

£4.24 ex VAT

£5.09 inc VAT



Code MC1302
Plain Sided Frosted Votive Glass

52 OD x 46 Base Dia x 65 H
x 6mm Thick

£1.66 ex VAT

£1.99 inc VAT



Code MC1427
Plain Sided Clear Votive Glass

55 OD x 49 Base Dia x 65 H
x 6mm Thick

£1.66 ex VAT

£1.99 inc VAT



Code MC1425
Square Tealight Votive Glass - Clear

50 W x 50 D x 55 H x 6mm Thick

£2.33 ex VAT

£2.79 inc VAT



Code MC1415
Glass Saucer For Oil Burners

120 Dia x 30 H

£1.66 ex VAT

£1.99 inc VAT



Code MC1252
Mushroom Base Tealight Holder - Frosted

90 OD x 50 Base Dia
x 40 H x 4mm Thick

£1.41 ex VAT

£1.69 inc VAT

Inspirational ideas



Easyfix Craft Accessories

A range of decorative accessories to give your metalwork project that something extra.



Easyfix Craft Accessories

A range of decorative accessories to give your metalwork project that something extra.

Items on this page are made from pressed steel (less than 1mm thick) and have a specially made tag welded to the back. The welded tag enables the items to be added to projects quickly and easily using either rivets or nut and bolt fixings as shown in the illustration below.

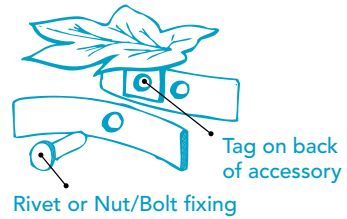

Code MC1313
L34 Easyfix Leaf
75 W x 75 H
£2.41 ex VAT
£2.89 inc VAT



Code MC090
W28 Easyfix Fleur De Lys
78 W x 100 H
£2.49 ex VAT
£2.99 inc VAT



Code MC094
W32 Easyfix Butterfly
55 Dia
£0.74 ex VAT
£0.89 inc VAT



A reminder that you can find our full range of tools & steel in our "Whats News Catalogue"



Useful Tip

When painting your finished metalcraft project, using a contrasting finish on the Easyfix accessory can really add a touch of quality and an extra dimension.



All sizes stated are approximate and in mm

Self Fix Craft Accessories

A comprehensive range of themed decorations that make your projects come alive.





Please see overleaf for our full range of great looking Self Fix Accessories.

Self Fix Craft Accessories

Celestial

All items shown on the following pages are made from pressed steel (approx 1mm thick).

Unlike the Easyfix range on page 13 they do not have the fixing tag on the back. However, with our ultra-strong **J-B Weld Epoxy Steel Resin** you make and attach your custom made fixing tag out of our 10mm x 1.6mm steel strip. When the fixing tag has bonded to the back of the accessory, you can then attach it anywhere you want on your finished project using rivets, nuts and bolts, or J-B Weld. Alternatively use our new powerful magnets MC1451, they can fix your chosen attachment in seconds, they are very discreet and can be re-used again and again.

Accessories can be made even more eye-catching when coloured up by paint, airbrush or even marker pen.



Code M1235

Pack of J-B Weld (Two Part – Liquid Steel) Adhesive

£9.99 ex VAT

£11.99 inc VAT

With our new ultra strong J-B Weld Epoxy Steel Resin you can attach your custom made fixing tags from our 10mm x 1.6mm (3/8" x 16 Gauge) material (see page 45).



Code MC708

M2 Star

120 W x 115 H

£3.16 ex VAT

£3.79 inc VAT



Code MC1210

M60 Sun

120 Dia

£3.33 ex VAT

£3.99 inc VAT



Code MC1211

M61 Moon

85 W x 95 H

£2.24 ex VAT

£2.69 inc VAT



Code MC1212

M16 Small Star

47 W x 50 H

£0.99 ex VAT

£1.19 inc VAT



Code MC755

Sun God

100 Dia

£2.49 ex VAT

£2.99 inc VAT



Code MC1451

Pack of 10 powerful N35 Neodymium Magnets

10mm Dia x 2mm H

£3.66 ex VAT

£4.39 inc VAT

All sizes stated are approximate and in mm

Self Fix Craft Accessories

Leaves, Fruit and Flowers



Code MC709

L27 Grapes

40 W x 80 H

£0.83 ex VAT

£0.99 inc VAT



Code MC720

L34 Maple Leaf

75 W x 75 H

£1.83 ex VAT

£2.19 inc VAT



Code MC1233

L51 Oak Leaf

38 W x 74 H

£2.08 ex VAT

£2.49 inc VAT



Code MC1234

**L29 Morning
Glory Leaf**

57 W x 65 H

£1.49 ex VAT

£1.79 inc VAT



Code MC1222

F3 Morning Glory

65 Dia x 55 Deep

£4.16 ex VAT

£4.99 inc VAT



Code MC1400

**F30 8 Petal
Flower**

55 Dia

£1.58 ex VAT

£1.89 inc VAT



Code MC1401

**F33 10 Petal
Flower**

94 H x 85 W

£1.99 ex VAT

£2.39 inc VAT



Code MC1437

Large Sunflower

135 Dia

£3.74 ex VAT

£4.49 inc VAT



Code MC1439

F21 Small Flower

55 Dia

£1.99 ex VAT

£2.29 inc VAT



All sizes stated are approximate and in mm

Self Fix Craft Accessories

Birds, Insects and Animals



LASER CUT

Code MC705
B2 Kingfisher
 108 W x 100 H
 £1.24 ex VAT
£1.49 inc VAT



Code MC707
B3 Owl
 75 W x 125 H
 £2.46 ex VAT
£2.95 inc VAT



Code MC1225
B4 Rooster
 123 W x 135 H
 £3.33 ex VAT
£3.99 inc VAT



Code MC1226
B7 Hen
 105 W x 110 H
 £3.24 ex VAT
£3.89 inc VAT



Code MC717
B10 Small Butterfly
 60 W x 43 H
 £1.66 ex VAT
£1.99 inc VAT



Code MC718
B11 Large Butterfly
 134 W x 97 H
 £3.08 ex VAT
£3.69 inc VAT



Code MC1213
B9 Medium Butterfly
 92 W x 64 H
 £2.16 ex VAT
£2.59 inc VAT



LASER CUT

Code MC1221
B12 Large Dragonfly
 150 W x 110 H
 £1.24 ex VAT
£1.49 inc VAT



Code MC1214
A27 Golden Retriever
 188 W x 130 H
 £4.08 ex VAT
£4.89 inc VAT



Code MC752
Cat
 145 W x 105 H
 £3.16 ex VAT
£3.79 inc VAT

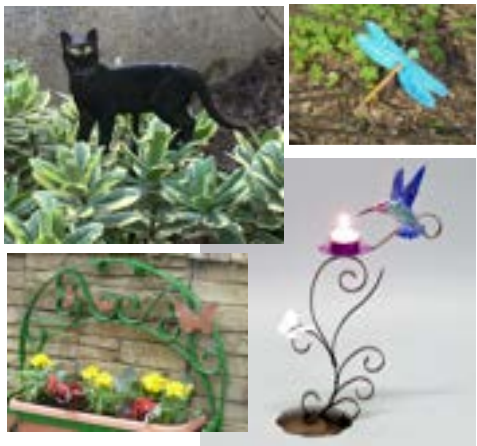

All sizes stated are approximate and in mm

Self Fix Craft Accessories

Emblems, Motifs and Christmas



LASER CUT

Code MC716
M9 Large Fleur de Lys
 78 W x 100 H
 £1.74 ex VAT
£2.09 inc VAT



Code MC719
M51 Griffins and Shield
 213 W x 83 H
 £3.99 ex VAT
£4.79 inc VAT



Code MC722
LS1 Heraldic Shield
 113 W x 137 H
 £1.83 ex VAT
£2.19 inc VAT



LASER CUT

Code MC757
Arrow Head
 60 W x 115 H
 £0.99 ex VAT
£1.19 inc VAT



LASER CUT

Code MC758
Arrow Vane
 55 W x 115 H
 £0.99 ex VAT
£1.19 inc VAT



LASER CUT

Code MC1216
Scottish Thistle
 110 W x 102 H
 £0.99 ex VAT
£1.19 inc VAT



Code MC1218
M44 Heart
 56 W x 60 H
 £1.16 ex VAT
£1.39 inc VAT



Code MC756
Xmas Bells
 108 W x 80 H
 £2.49 ex VAT
£2.99 inc VAT



Code MC1432
Xmas Tree
 85 W x 125 H
 £2.49 ex VAT
£2.99 inc VAT



All sizes stated are approximate and in mm

Decorative Features

Weldable decorative embellishments to add elegance to gates, fences and other projects.

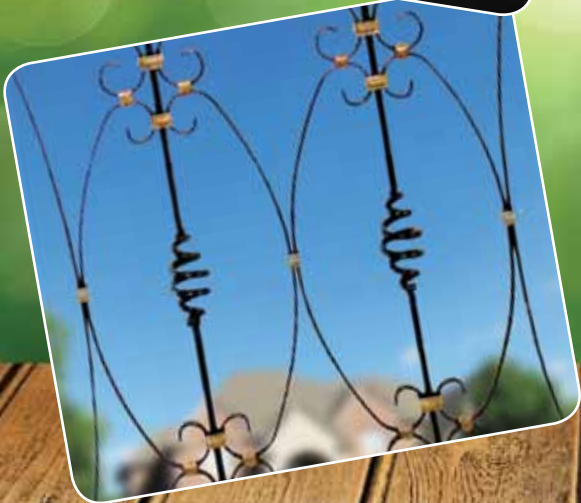
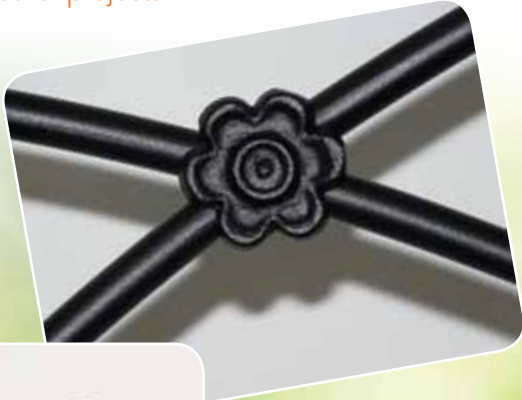



See overleaf for our full range of weldable decorative features.

Decorative Features

Railing Tops in two sizes

We provide a comprehensive range of railing and post tops, as well as solid or hollow weldable balls.

In addition, our bushings and more elaborate decorative baskets, provide great features to fence and gate pickets. However, it's not just gates and fences that these features can be added to. When you look through the pages of our Catalogue and Accessories Booklet you will see a whole host of ideas that you can affix these items to if you have welding equipment.



Code MCWR151

Railing Top
£0.58 ex VAT

£0.69 inc VAT

Code MCWR152

Railing Top
£1.08 ex VAT

£1.29 inc VAT



Code MCWR66

Railing Top
30 W x 125 H x 10 Base
£0.74 ex VAT

£0.89 inc VAT

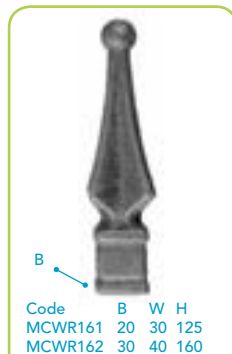

Code MCWR161

Railing Top
£0.66 ex VAT

£0.79 inc VAT

Code MCWR162

Railing Top
£2.08 ex VAT

£2.49 inc VAT

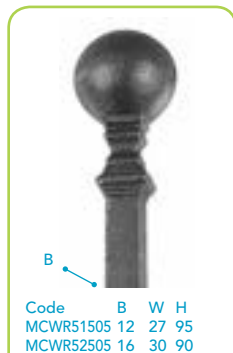

Code MCWR51505

Railing Top
£0.49 ex VAT

£0.59 inc VAT

Code MCWR52505

Railing Top

DISCONTINUED

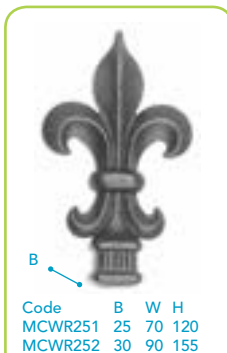

Code MCWR251

Railing Top
£1.24 ex VAT

£1.49 inc VAT

Code MCWR252

Railing Top

DISCONTINUED

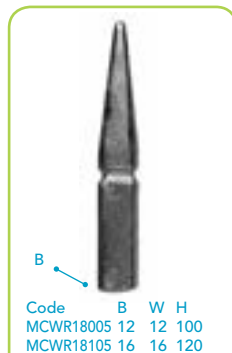

Code MCWR18005

Railing Top
£0.83 ex VAT

£0.99 inc VAT

Code MCWR18105

Railing Top
£0.99 ex VAT

£1.19 inc VAT

All sizes stated are approximate and in mm

Inspirational ideas



Decorative Features

Pre-Fabricated Post Tops

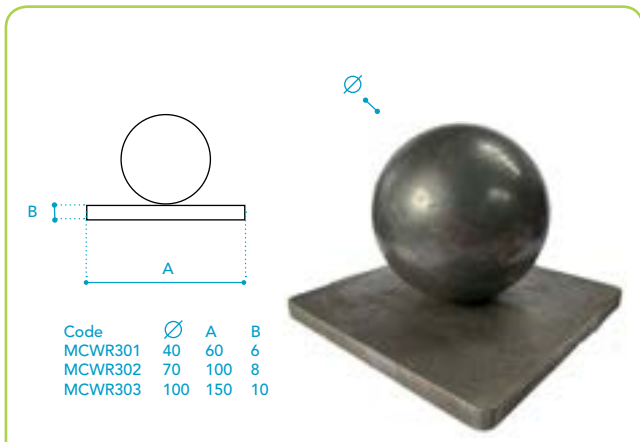

| Code | ∅ | A | B |
|---------|-----|-----|----|
| MCWR301 | 40 | 60 | 6 |
| MCWR302 | 70 | 100 | 8 |
| MCWR303 | 100 | 150 | 10 |

Code
MCWR301

Post Top
£3.74 ex VAT
£4.49 inc VAT

Code
MCWR302

Post Top
£6.24 ex VAT
£7.49 inc VAT

Code
MCWR303

Post Top
£14.16 ex VAT
£16.99 inc VAT

Balls



Code MCWR501

Solid Sphere 40 Dia

Weight – 0.27kg

£1.16 ex VAT £1.39 inc VAT

Code MCWR502

Solid Sphere 70 Dia

Weight – 1.41kg

DISCONTINUED

Code MCWR503

Solid Sphere 100 Dia

Weight – 4.14kg

£10.83 ex VAT £12.99 inc VAT

Code MCWR504

Solid Sphere 20 Dia

Weight – 0.03kg

£0.33 ex VAT £0.39 inc VAT

Code MCWR04003

Hollow Sphere 40 Dia

Weight – 0.13kg

£0.91 ex VAT £1.09 inc VAT

Code MCWR07003

Hollow Sphere 70 Dia

Weight – 0.38kg

£2.49 ex VAT £2.99 inc VAT

Code MCWR10003

Hollow Sphere 100 Dia

Weight – 0.71kg

£5.41 ex VAT £6.49 inc VAT

Other sizes of sphere are available on request (subject to minimum order).

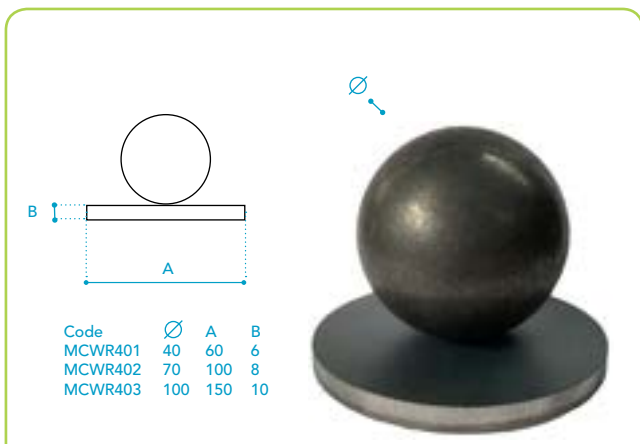

| Code | ∅ | A | B |
|---------|-----|-----|----|
| MCWR401 | 40 | 60 | 6 |
| MCWR402 | 70 | 100 | 8 |
| MCWR403 | 100 | 150 | 10 |

Code
MCWR401

Post Top
£3.74 ex VAT
£4.49 inc VAT

Code
MCWR402

Post Top
£6.24 ex VAT
£7.49 inc VAT

Code
MCWR403

Post Top
£14.16 ex VAT
£16.99 inc VAT

Decorative Features

Bushings for Fence Pickets



Code \varnothing H
 MCWR10613 40 40
 MCWR10615 40 40

Code MCWR10613

Round Bushing for 12mm Round Pickets

£0.99 ex VAT **£1.19 inc VAT**

Code MCWR10615

Round Bushing for 16mm Round Pickets

£0.99 ex VAT **£1.19 inc VAT**

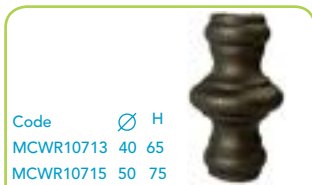

Code \varnothing H
 MCWR10713 40 65
 MCWR10715 50 75

Code MCWR10713

Round Bushing for 12mm Round Pickets

£0.91 ex VAT **£1.09 inc VAT**

Code MCWR10715

Round Bushing for 16mm Round Pickets

£2.08 ex VAT **£2.49 inc VAT**

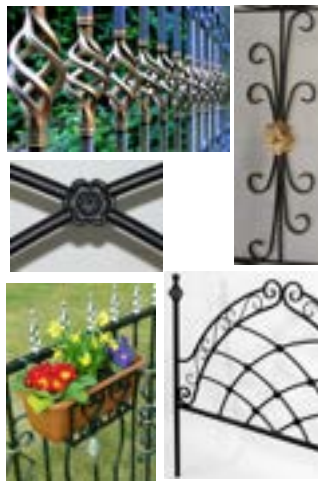

Decorative Baskets



Code MCWR04011

18mm Square Base 8 Strand Decorative Basket
 130 H x 80 Dia

£2.74 ex VAT **£3.29 inc VAT**



Code MCWR02211

12mm Round Base Single Strand Coil Basket
 330 H x 60 Dia

£4.58 ex VAT **£5.49 inc VAT**

Rosettes



Code MC1292 Open Petal Rosette

4 Thick x 90 Dia

£1.49 ex VAT
£1.79 inc VAT



Code MC1293 Rosette with Stalk

3 Thick x 70 Dia (Stalk
 length at back 20)

£1.41 ex VAT
£1.69 inc VAT



Code MC1294 Small Rosette

3 Thick x 45 Dia

£0.58 ex VAT
£0.69 inc VAT



Code MC1295 Closed Rosette

3 Thick x 40 H x 50 Dia

£0.91 ex VAT
£1.09 inc VAT

All sizes stated are approximate and in mm

Gate Hardware

Latch Components

A range of essential gate furniture which allows you to make and install gates of all sizes.

Our selection includes strong steel latches, catches and hinges to give your gate a professional finish.



Code MCGR105
Latch
 £1.99 ex VAT
£2.39 inc VAT



Code MCGR106
Latch Pivot
 £0.91 ex VAT
£1.09 inc VAT



Code MCGR107
Latch Support
 £0.58 ex VAT
£0.69 inc VAT



Code MCGR122
Double Gate Catch
 £1.16 ex VAT
£1.39 inc VAT



Code MCGR123
Gate Latch Fastener
 £2.49 ex VAT
£2.99 inc VAT

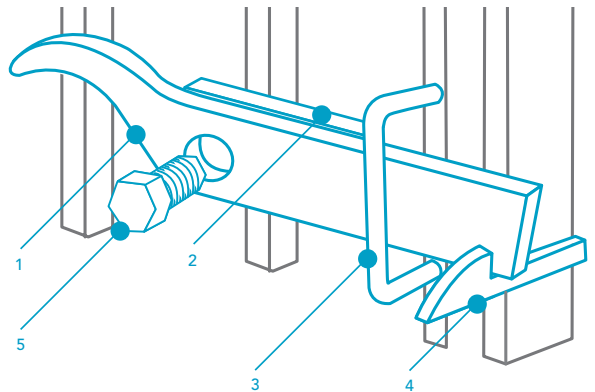
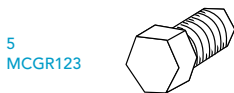
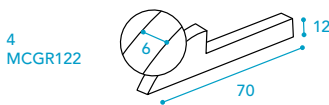
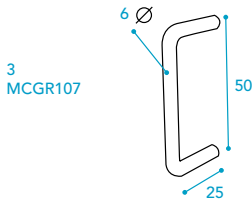
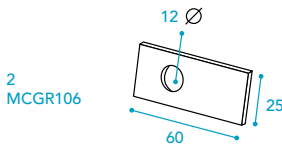
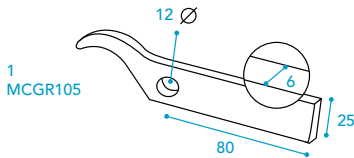

All sizes stated are approximate and in mm

Gate Hardware

Hinge Pin Components

Hinge Pin with Fixing Plate perfect for fixing gates to masonry and sturdy wooden gateposts.



| Code | Ø | A1 | A2 | B | C | D |
|---------|----|-----|-----|-----|----|---|
| MCGR110 | 12 | 130 | 110 | 110 | 20 | 8 |
| MCGR111 | 16 | 150 | 120 | 120 | 25 | 8 |
| MCGR112 | 20 | 160 | 120 | 130 | 30 | 8 |

Code MCGR110
12mm Hinge Pin with Fixing Plate
£3.49 ex VAT
£4.19 inc VAT

Code MCGR111
16mm Hinge Pin with Fixing Plate
DISCONTINUED

Code MCGR112
20mm Hinge Pin with Fixing Plate
£5.16 ex VAT
£6.19 inc VAT

Weldable Hinge Pins (for fixing gates to metal posts and frames)

| Ø | A1 | A2 | B1 | B2 | B3 | D |
|----|----|----|----|----|----|----|
| 25 | 60 | 35 | 50 | 20 | 30 | 50 |

Code MCGR126
25mm Weldable Hinge Pin
£5.99 ex VAT
£7.19 inc VAT

| Code | Ø | A1 | A2 | B |
|---------|----|----|----|----|
| MCGR113 | 12 | 33 | 20 | 25 |
| MCGR114 | 16 | 40 | 25 | 30 |
| MCGR115 | 20 | 50 | 30 | 40 |

Code MCGR113
12mm Weldable Hinge Pin
£0.91 ex VAT
£1.09 inc VAT

Code MCGR114
16mm Weldable Hinge Pin
£1.41 ex VAT
£1.69 inc VAT

Code MCGR115
20mm Weldable Hinge Pin
£1.83 ex VAT
£2.19 inc VAT

All sizes stated are approximate and in mm

Gate Hardware

Hinge Components

Adjustable Hinges makes fitting and aligning gates easy.

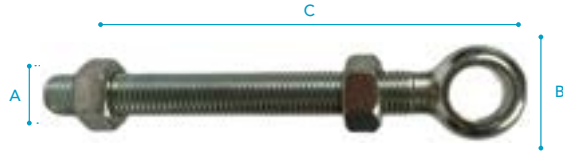

| Code | Fits over hinge pin size | | |
|---------|--------------------------|----|-----|
| | A | B | C |
| MCGR116 | 12 | 25 | 113 |
| MCGR117 | 16 | 32 | 166 |
| MCGR118 | 20 | 40 | 170 |
| MCGR127 | 25 | 45 | 200 |

Code MCGR116
12mm Adjustable Hinge
£1.83 ex VAT
£2.19 inc VAT

Code MCGR117
16mm Adjustable Hinge
£1.91 ex VAT
£2.29 inc VAT

Code MCGR118
20mm Adjustable Hinge
£2.91 ex VAT
£3.49 inc VAT

Code MCGR127
25mm Adjustable Hinge
£6.66 ex VAT
£7.99 inc VAT

Weldable Hinges for attaching directly to gate frames.

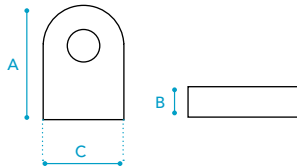

| Code | Fits over hinge pin size | | |
|---------|--------------------------|----|----|
| | A | B | C |
| MCGR119 | 12 | 10 | 25 |
| MCGR120 | 16 | 10 | 30 |
| MCGR121 | 20 | 12 | 40 |
| MCGR128 | 25 | 20 | 50 |

Code MCGR119
12mm Weldable Fixed Hinge
£0.74 ex VAT
£0.89 inc VAT

Code MCGR120
16mm Weldable Fixed Hinge
£2.99 ex VAT
£3.59 inc VAT

Code MCGR121
20mm Weldable Fixed Hinge
£1.24 ex VAT
£1.49 inc VAT

Code MCGR128
25mm Weldable Fixed Hinge
£3.59 ex VAT
£4.31 inc VAT

All sizes stated are approximate and in mm

Gate Hardware

Drop Bolt Sets and Hold Back Components

Our 5-piece Drop Bolt Set keeps your gates fixed in the closed (or open) position.

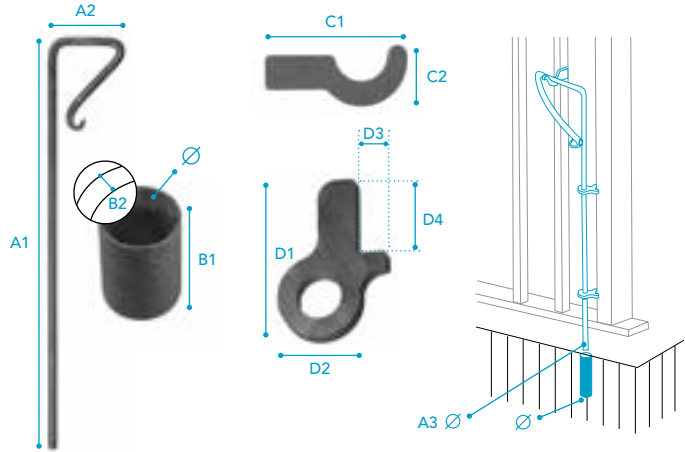

| Code | A3 | ∅ | A1 | A2 | B1 | B2 | ∅ | C1 | C2 | D1 | D2 | D3 | D4 |
|---------|----|-----|-----|----|----|----|----|----|----|----|----|----|----|
| MCGR124 | 12 | 700 | 120 | 50 | 3 | 20 | 65 | 26 | 47 | 32 | 8 | 22 | |
| MCGR125 | 16 | 700 | 135 | 50 | 4 | 25 | 65 | 26 | 56 | 37 | 8 | 27 | |
| MCGR129 | 20 | 700 | 140 | 50 | 3 | 27 | 65 | 26 | 60 | 41 | 8 | 27 | |

Code MCGR124
5 Pc. Drop Bolt Set
(for small-medium
sized gates) – SM
£7.49 ex VAT
£8.99 inc VAT

Code MCGR125
5 Pc. Drop Bolt Set
(for larger sized
gates) – L
£9.99 ex VAT
£11.99 inc VAT

Code MCGR129
5 Pc. Drop Bolt Set
(for extra large sized
gates) – XL
£12.91 ex VAT
£15.49 inc VAT

Hold Back
for holding your
gates open. Simply
fix into the ground
at the required
height.

Code MCGR109
Hold Back
£9.99 ex VAT
£11.99 inc VAT

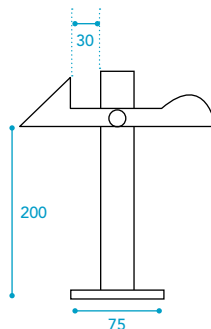

All sizes stated are approximate and in mm

Clock Components

Our great range of clock inserts, movements, hands, dials, clock faces and back plates enable you to design and create an endless variety of classical and contemporary timepieces.





See overleaf for all of our clock components and prices.

Clock Components

Clock Inserts

For those looking for speed and convenience we supply these ready-made battery powered 65mm diameter clock inserts which simply fix into your design as shown in this carriage clock project.

These clock inserts are *normally provided with three flexible steel spring clips as shown here which are designed to grip to the right sized aperture (58-62mm Dia). To fit into a Metalcraft design you can roll rings approx. 58-62mm diameter using steel strip to hold these inserts. Both inserts are designed take 1.55V LR-1, AM5 or UM5 or N Size or equivalent batteries (not included).

*note that due to suppliers changes the springs can sometimes be replaced by an alternative rubber gasket which works in a similar manner."



Code MC1353W

65mm Round Clock Insert (White Dial)

65 Outer Dia x 30 Deep

(Designed to fit aperture diameter of 58-62 and 17 Deep)

£12.49 ex VAT

£14.99 inc VAT



Code MC1353G

65mm Round Clock Insert (Gold Dial)

65 Outer Dia x 30 Deep

(Designed to fit aperture diameter of 58-62 and 17 Deep)

£12.49 ex VAT

£14.99 inc VAT

All sizes stated are approximate and in mm

Clock Components

Quartz Clock Movements



Code MC1240
Quartz Clock Movement
(Spindle Length 14mm)
 55 W x 55 H x 15 Deep plus 14mm
 long spindle
£3.74 ex VAT
£4.49 inc VAT



Code MC1241
Quartz Clock Movement
(Spindle Length 23mm)
 55 W x 55 H x 15 Deep plus 23mm
 long spindle
£3.74 ex VAT
£4.49 inc VAT

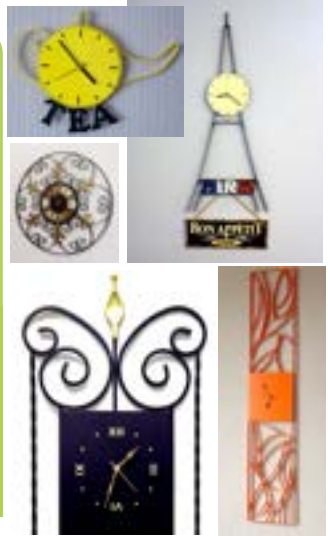

Our quartz clock movements featured here run on a single 1.5V AA battery (not supplied) and are provided with the necessary components to construct your own clock projects.

The basic movement is available with either a short spindle (14mm long), which is designed for clock faces 0.5mm to 4mm thick or a long spindle (23mm long), which is designed for clock faces 10-12.5mm thick.

Note, if a small piece of packing material or thick washer is fixed to the back of the clock face, the long spindle version can be used for clock face thicknesses between 4mm and 10mm.

The spindles themselves require an 8.5mm hole in the clock face to fit through. For convenience why not use one of our purpose made clock back plates (see page 35) which can be riveted into surrounding metal frames.

As an alternative, we can also provide a pendulum movement with a 23mm spindle length. This comes with an attractive pendulum bob and rod, and this works with our Grandfather Clock Face (also on page 35).

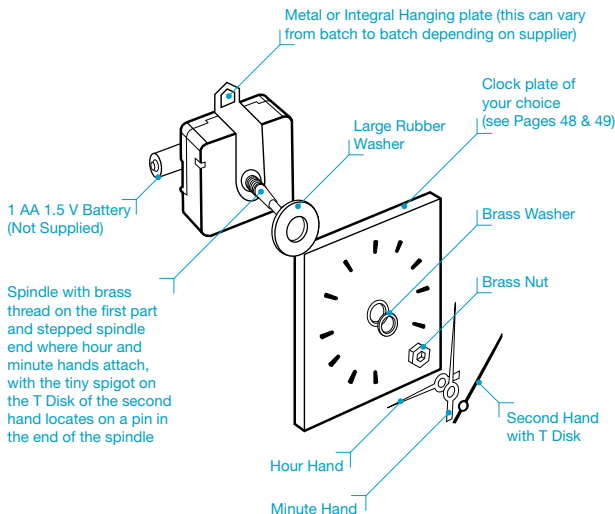

All sizes stated are approximate and in mm

Clock Components

Hands and Chapter Rings

For those wishing to provide a classical brass effect numbered clock face we offer two chapter ring sizes (5" and 7") to match the available hand sizes. Alternatively, we now offer laser cut clock faces on the next page.

Three different style of hands are available in black or gold. The MC1245/MC1245G hands are better suited for use with a 5" (126mm) diameter clock dial (chapter ring) or our smaller clock face/plates (on page 35). The other two styles are better suited for use with a 7" (176mm) diameter clock dial (chapter ring) or larger clock face/plates.

The second hand is fitted with a small brass "T Disk" in the centre which keeps the other hands securely in place. If the second hand is not required its arms can be trimmed off with scissors so the T Disk is fitted as a simple cap to ensure an attractive finish. (Please note due to supplier sourcing, the style of the hands shown here may vary slightly from the image shown).



Code MC1243
5" Chapter Ring (Roman Numerals)

126 Outer Dia
 x 70 Inner Dia
 x 1mm Thick

£4.58 ex VAT
£5.49 inc VAT

Code MC1246
7" Chapter Ring (Roman Numerals)

176 Outer Dia
 x 100 Inner Dia
 x 1mm Thick

£4.83 ex VAT
£5.79 inc VAT



Code MC1244
5" Chapter Ring (Standard Numerals)

126 Outer Dia
 x 70 Inner Dia
 x 1mm Thick

£4.58 ex VAT
£5.49 inc VAT

Code MC1247
7" Chapter Ring (Standard Numerals)

176 Outer Dia
 x 100 Inner Dia
 x 1mm Thick

DISCONTINUED

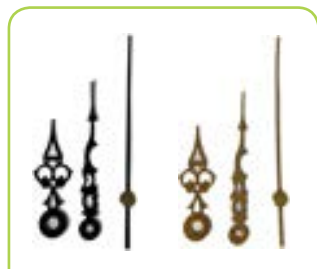

Code MC1245/MC1245G
 (Black) (Gold)
Hour, Minute and Second Hand Set for 5" Chapter Ring

60mm Minute Hand, 42mm Hour Hand, 68mm Second Hand

£0.83 ex VAT
£0.99 inc VAT

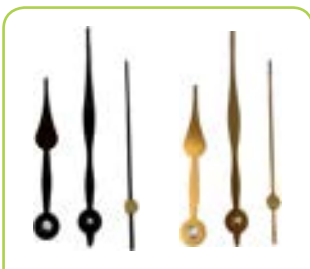

Code MC1248/MC1248G
 (Black) (Gold)
Hour, Minute and Second Hand Set for 7" Chapter Ring

80mm Minute Hand, 58mm Hour Hand, 80mm Second Hand

£0.83 ex VAT
£0.99 inc VAT

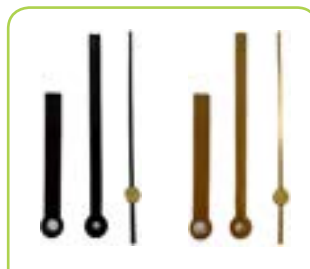

Code MC1354/MC1354G
 (Black) (Gold)
Modern Style Hour, Minute and Second Hand Set for 7" Dials

80mm Minute Hand, 55mm Hour Hand, 75mm Second Hand

£0.83 ex VAT
£0.99 inc VAT

All sizes stated are approximate and in mm

Clock Components

Clock Plates

Precision laser cut clock faces and matching back plates in a self-colour finish.

Designed for use with our collection of clock movements and hands shown on the previous pages to make fantastic looking clocks.



1. First select your preferred clock and then select the matching sized back plate. To make the dial stand out paint the back plate in a contrasting colour to the clock face.



2. Then fit one of our quartz clock movements together with the preferred style of clock hands. This can be riveted to any supporting metalwork frame to make a wall clock.



3. Our special grandfather clock face can be used with our MC1264 of MC1266 backplate and our MC1242 Pendulum movement. To make a great looking grandfather clock which can then be incorporated into your metalwork by riveting or nut and bolt fixings.



Code MC1264
Large Round
Clock Back Plate

194 Dia with 8.5mm Dia
Hole x 2 Thick

£2.49 ex VAT
£2.99 inc VAT

Code MC1265
Small Round
Clock Back Plate

140 Dia with 8.5mm Dia
Hole x 2 Thick

£1.66 ex VAT
£1.99 inc VAT

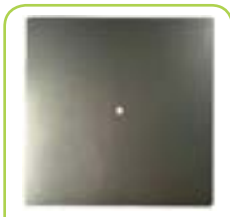

Code MC1266
Large Square
Clock Back Plate

194 Sq with 8.5mm Dia
Hole x 2 Thick

£2.49 ex VAT
£2.99 inc VAT

Code MC1267
Small Square
Clock Back Plate

140 Sq with 8.5mm Dia
Hole x 2 Thick

£1.66 ex VAT
£1.99 inc VAT



Code MC1402
Modern Square
Clockface (Large)

194 Square x 1 Thick
Works best with MC1248/
MC1248G or MC1408/
MC1408G Hands.

£2.91 ex VAT
£3.49 inc VAT



Code MC1403
Modern Round
Clockface (Large)

194 Dia x 1 Thick
Works best with MC1248/
MC1248G or MC1408/
MC1408G Hands.

£2.91 ex VAT
£3.49 inc VAT



Code MC1404
Roman Square
Clockface (Small)

140 Square x 1 Thick
Works best with MC1245/
MC1245G Hands.

£2.08 ex VAT
£2.49 inc VAT



Code MC1405
Roman Round
Clockface (Small)

140 Dia x 1 Thick
Works best with MC1245/
MC1245G Hands.

£2.08 ex VAT
£2.49 inc VAT

All sizes stated are approximate and in mm

Letters & Numbers, Back & Base Plates, Connector Plates & Collars

Some inspirational laser cut ideas that will help your projects hang together.





See overleaf for our full range of products for our full range of features.

Letters and Numbers

Letters and numbers for signs, weathervanes and house number plates.

Available in a choice of three different fonts and two different sizes for each font.

The smaller 60mm high letters are 3mm thick and can be joined into metalwork by welding, using our new powerful magnets or riveting (with holes punched on Practical, Master Punch/Shears and XL5+ Power Bender). The larger 120mm high letters are 5mm thick and can be joined into metalwork by welding, magnets, or riveting (with holes punched on the Master Punch/Shear and XL5+ Power Bender).

When ordering any of these items using our order form complete the Order Code in the code column and then write which letters/numbers are required with quantity of each letter in brackets next to it.

e.g. MCLN005 M(1), E(1), T(2), A(2), L(1), C(1), R(1), F(1) put 10 in Quantity Column.

All sizes stated are approximate and in mm

METALCRAFT
ABCDEFGHIJKLMN
OPQRSTUVWXYZ
1234567890 @ - ‘.

Code MCLN001

Rustic Letters and Numbers (Small)

60 H x 3 Thick

£1.33 ex VAT £1.59 inc VAT

Code MCLN002

Rustic Letters and Numbers (Large)

120 H x 5 Thick

£2.91 ex VAT £3.49 inc VAT

METALCRAFT
ABCDEFGHIJKLMN
OPQRSTUVWXYZ
1234567890 & - ‘.

Code MCLN003

Classic Letters and Numbers (Small)

60 H x 3 Thick

£1.33 ex VAT £1.59 inc VAT

Code MCLN004

Classic Letters and Numbers (Large)

120 H x 5 Thick

£2.91 ex VAT £3.49 inc VAT

METALCRAFT
ABCDEFGHIJKLMN
OPQRSTUVWXYZ
1234567890 & - ‘.

Code MCLN005

Modern Letters and Numbers (Small)

60 H x 3 Thick

£1.33 ex VAT £1.59 inc VAT

Code MCLN006

Modern Letters and Numbers (Large)

120 H x 5 Thick

£2.91 ex VAT £3.49 inc VAT

Back/Base Plates and Accessories

Add a touch of class to your project with our range of shaped back and base steel plates.

The back and base plates come in three styles. Each style is available in large and small sizes. The larger versions are made from 3mm thick mild steel sheet and their smaller counterparts from 2mm. As you will see from the examples they can be used in a variety of ways for wall sconces, sturdy bases, and fixing plates. Don't forget you can also use the round and square clock back plates in a similar way (page 35) as well our new range of silhouettes in our What's New Catalogue.



Code MC1254

Large Classic Back/Base Plate

105 W x 210 H x 3 Thick

£2.49 ex VAT

£2.99 inc VAT

Code MC1255

Small Classic Back/Base Plate

76 W x 150 H x 2 Thick

£1.66 ex VAT

£1.99 inc VAT



Code MC1258

Large Bowed Split Back/Base Plate

54 W x 210 H x 3 Thick

£1.66 ex VAT

£1.99 inc VAT

Code MC1259

Small Bowed Split Back/Base Plate

30 W x 160 H x 2 Thick

£0.83 ex VAT

£0.99 inc VAT



Code MC1262

Large Diamond Back/Base Plate

153 W x 189 H x 3 Thick

£2.49 ex VAT

£2.99 inc VAT

Code MC1263

Small Diamond Back/Base Plate

103 W x 127 H x 2 Thick

£1.24 ex VAT

£1.49 inc VAT

Code MC1274

Large Self Adhesive Clear Rubber Bumper Feet (Pack of 10)

10 Dia x 3.1 Thick

£0.91 ex VAT

£1.09 inc VAT

Code MC1275

Small Self Adhesive Clear Rubber Bumper Feet (Pack of 10)

8 Dia x 2.1 Thick

£0.83 ex VAT

£0.99 inc VAT



Where plates may come into contact with wood, glass or painted surfaces, we offer two sizes of adhesive backed rubber bumper feet (sold in strips of ten) to protect surfaces from scratches.

All sizes stated are approximate and in mm

Connector Plates and Collars

Connector Collars

Allows you to create complex 3D metalwork, quickly and easily.

Three sizes of collar are available enabling you to connect multiple metalwork components together by riveting or nut and bolt fastening instead of having to weld.

Any punch/shear tool in our range can be used to punch the necessary fixing hole in the collar.



Code MC1289
Small Connecting Collar

25 Outer Dia x 16 Long
£0.49 ex VAT
£0.59 inc VAT



Code MC1290
Medium Connecting Collar

32 Outer Dia x 20 Long
£0.66 ex VAT
£0.79 inc VAT



Code MC1291
Large Connecting Collar

38 Outer Dia x 25 Long
£0.83 ex VAT
£0.99 inc VAT



Collar with riveted end fixing.



Collar with nut and bolt fixing.



All sizes stated are approximate and in mm

Connector Plates and Collars

Connector Plates



Code MC1269
Large Half Disc
Connector Plates
150 Dia x 3 Thick
£1.66 ex VAT
£1.99 inc VAT



Code MC1270
Small Half Disc
Connector Plates
100 Dia x 2 Thick
£1.24 ex VAT
£1.49 inc VAT

Our Candle Trays on pages 6-7 (Ref: MC079, MC088, MC954, MC1160, MC955 and MC956) can be used when you are making a circular wrought iron basket, bowl or cauldron.

Any punch/shear tool in our range can be used to punch the necessary fixing hole in the plate. Metal strips can then be riveted or bolted to the plate to form the basket, bowl or cauldron.



Half Disc connector plate used to make half basket.



Candle tray connector plate.

For half baskets we also offer a large and small half connector plate which is useful when making things like wall mounted haybaskets as shown here.



All sizes stated are approximate and in mm

Sundries Section

We also offer this great range of Raaco Organiser Boxes with or without bundles of our fixings.

Enthusiastic Metalcrafters will appreciate that a workbench can soon get into a mess. Hunting for vital components and fixings is time consuming and lost components can be costly to replace, which is why these organiser boxes are a must.

Our Small Organiser box is the ideal way to keep nuts and bolts, rivets, allen keys and small components close at hand. With four removable inner trays, you can also use the empty organiser box as a safe place to keep your operating instructions, spare parts drawings etc. Check out these pages for great bundle deals on our small and medium organiser boxes complete with packs of rivets and nuts and bolts.

Our Medium Organiser Box contains 15 removable trays* and is suited to storing larger components and accessories making it a useful accompaniment to Practical and Master ranges.

* Please note that due to supplier changes colour may vary to that shown and number of trays may change to 14 depending on stock availability.



Code MC1271
Small Organiser Box c/w 4 Removable Assorter Boxes

241 W x 56 H x 195 D

£8.33 ex VAT

£9.99 inc VAT



Code MC1272
Medium Organiser Box c/w 15 * Removable Assorter Boxes

338 W x 57 H x 261 D

£11.66 ex VAT

£13.99 inc VAT



Code MC1271R
Small Organiser Box (MC1271) plus bulk pack of 5mm Rivets

241 W x 56 H x 195 D

Contains: 1 Pack each 5mm Rivets MC054L, MC055L, MC056L, MC057L

£37.49 ex VAT

£44.99 inc VAT



Code MC1271NB
Small Organiser Box (MC1271) plus bulk pack of 5mm Nuts and Bolts

241 W x 56 H x 195 D

Contains: 1 Pack each 5mm Nyloc Nuts and Button Head 3mm Hex Socket M5 Bolts MC062, MC063, MC064, MC065

£37.49 ex VAT

£44.99 inc VAT



Code MC1272IWCC
Medium Organiser Box (MC1272) plus bulk pack of 3mm Nuts and Bolts and Rivets

338 W x 57 H x 261 D

Contains: 1 Pack each 3mm Rivets MC050L, MC051L, MC052L, MC053L and 1 Pack each 3mm Nuts and Bolts MC058L, MC059L, MC060L, MC061L

£36.66 ex VAT

£43.99 inc VAT

All sizes stated are approximate and in mm

Gift Vouchers

If you are shopping for a Metalcrafter in your family why not give Metalcraft Gift Vouchers (for UK Customers only) for birthdays, saying thanks, rewards or at Christmas.



Not sure what to get the Metalcrafter in your life?

Why not try our Metalcraft vouchers!

Available in denominations of:

| | |
|------------------|-------------|
| £5 Gift Voucher | Code MC1181 |
| £10 Gift Voucher | Code MC1182 |
| £20 Gift Voucher | Code MC1183 |
| £50 Gift Voucher | Code MC1184 |

Don't forget to check out our webstore

www.metalcrafttools.com

As we have a special page for clearance sale items plus special deals, promotions and even ex-demo metalcraft tools.

Also bear in mind that if you register for a 'Login Account' on our webstore you will also get special access to our 'Free Stuff' page which is packed full of great PDF downloads.

How to Order

How to Order (UK ONLY)

If based in the UK, you can order from us via our website at www.metalcrafttools.com or complete the double sided Order Form opposite, remembering to state the order code, quantity, description, and inc VAT price each and total price inc VAT for each line. Then total up all the figures in the Total Price inc VAT column and enter the result in the Sub Total (inc VAT) box.

Work out the postage and packing from the table below and put the relevant figure into the Postage and Packing box on the Order Form. Add postage and packing amount from table below to Sub Total (inc VAT) and complete Order Total box to work out amount payable.

On reverse side of Order Form, complete customer name, address and phone number details clearly and accurately including delivery address and delivery contact numbers if different. If time permits, help us to improve our product range and service in future by completing the short questionnaire.

| UK Packing and Delivery Charges | |
|---|-------------------------------------|
| Any order for £150 or over | Free |
| Orders for £15 or over and less than £150 | Add £9.99 to P&P Box on order form |
| Orders for less than £15 | Add £6.99 to P&P Box on order form |
| All orders received before 2.00 pm are usually delivered on a 'next working day service' (subject to stock availability) to UK mainland addresses. Note - Delivery to Isle of Wight, Isle of Man, Channel Isles, N Ireland, and Scottish Highlands and Isles may take an extra 1-2 days. To guarantee next day delivery (UK Mainland only) add this amount to your order irrespective of the order value. | Add £12.99 to P&P Box on order form |

Methods of Payment (UK ONLY)

Payment with order unless agreed otherwise

CHEQUE/POSTAL ORDER These should be made payable to 'J & C R WOOD LTD' and sent with order.

CREDIT/DEBIT CARD Visa/Mastercard/Visa Delta/Electron/JCB and UK Maestro cardholders can order directly by phone, fax or by post. We need your full card details, name and address and telephone number of cardholder, expiry date and security code (the last 3 digits on the signature strip on the reverse side of the card).

In the case of Maestro (not UK) we can only accept payment from visitors who present the card at our premises and can enter their Pin Number.

CASH We cannot accept responsibility for loss of cash sent through the post.

GIFT VOUCHERS If you wish to use any gift vouchers as part or full payment, the original voucher must be submitted by post and must be a valid and fully completed voucher.

ONLINE Please note our online store at www.metalcrafttools.com accepts credit/debit card payments or if preferred, you have the option to pay via the Paypal website if you have a Paypal account or by Credit/Debit card through the Paypal website's guest facility.

How to Order (EUROPE)



If based in Europe, we can supply the majority of products from our range direct to your door at sensible delivery costs. If a product is marked with the icon (left) it means that we are unable to supply at the quoted delivery price and costs to ship to Europe are likely to be prohibitive.

These costs vary depending in which country you are based and are subject to VAT where applicable. To establish the cost to send any of our goods to your preferred delivery address, we strongly recommend visiting our website www.metalcrafttools.com. At the top of the page you can create a no obligation 'Login Account' and once you have registered you can select the products of interest into your shopping basket and use the 'Checkout' to identify delivery costs to your shipping address. Alternatively, you can phone us on +44 (0)1482 345067 or email us at info@jandcwood.co.uk with your telephone number and the relevant product (MC...) codes and quantities and we will provide a quotation for a delivered cost.

Methods of Payment (EUROPE)

Payment with order unless agreed otherwise

ONLINE Please note our online store at www.metalcrafttools.com accepts credit/debit card payments or if preferred, you have the option to pay via the Paypal website if you have a Paypal account or by credit/debit card through the Paypal website's guest facility.

PAYPAL If you don't wish to use our website and have requested a quote by telephone or email you can pay in advance through Paypal directly to barry.wood@jandcwood.co.uk

BANK TRANSFER If you don't wish to use our website and have requested a quote by telephone or email you can pay in advance by bank transfer to our bank account (details available on request).

How to Order (OUTSIDE OF EUROPE)

We can supply to selected countries outside of Europe, provided they are not covered by our network of distributors around the world. To find out more go to www.metal-craft.co.uk/international, follow the instructions and if necessary complete the online form with your contact details and we will either refer you to your nearest distributor or we will respond to you with a quotation if your country is not covered by our distribution network.

Alternatively, you can phone us on +44 (0)1482 345067 or email us at info@jandcwood.co.uk with your contact details and country of origin.

Methods of Payment (OUTSIDE OF EUROPE)

Payment with order unless agreed otherwise

ONLINE Please note our online store at www.metalcrafttools.com only processes orders from the UK and Europe.

PAYPAL If you have received an official quotation from us you can pay in advance through Paypal directly to barry.wood@jandcwood.co.uk

BANK TRANSFER We can accept payment by bank transfer in GB Pounds (£) or if necessary by US Dollars (\$) (bank account details available on request).

UK Order Form



VAT Reg. No GB167 9166 23

Issue 12 (2023)

I wish to pay by the following method:

Visa/Mastercard Visa Delta/Electron/JCB UK Maestro

Card No.

Expiry Date /
M M / Y Y

Security Code (i.e. the last 3 digits on the signature strip)

Card Holder's Signature: _____

Date Of Order: _____

Cheque/Postal Orders/Cash (Payable to J & C R Wood Ltd)

Total Order Value £ _____

Invoice Address: Customer Details

Account Ref (if known): _____

Mr/Mrs/Miss: _____

_____ Post Code _____

Tel No.: _____

Delivery Address (If different from Invoice Address)

Mr/Mrs/Miss: _____

_____ Post Code _____

Tel No.: _____

We would appreciate it if you could help us by sparing the time to answer the following questions:

1. Have you purchased items from us before? No Yes If Yes, 6 Digit – Account Reference if known: _____

2. Where did you first hear about Metalcraft? Advert Title of Publication: _____

Internet Exhibition Which event: _____ Recommendation

Other (please specify) _____

3. Are the goods listed overleaf to be used for: A Hobby Business Education/Training

4. What do you actually plan to make and/or repair with 'Metalcraft' tools or materials _____

Thank you for taking the time to complete this section, your information will be used for marketing purposes only, if you DO NOT wish to receive future mailings from us, please tick here



The Essential Range of Equipment for Crafting Metal



This catalogue showcases our existing range of accessories. To see our new range of Tools, materials and newest additions to our accessories contact us today to ask us to send our free

Metalcraft What's New Catalogue Issue 12

OR

Visit our webstore

www.metalcrafttools.com

where you can see the latest full range of products, including any special deals, promotions, or ex demo tools. If you register for a no obligation 'Login account' you will also get access to our 'Free stuff' page of downloadable project sheets, sales literature and tool instruction books.



CONTACT US TODAY AT



Registered Office

66 Clough Road, Hull HU5 1SR

t 01482 345067

f 01482 441141

e info@jandcrwood.co.uk

Registered in England and Wales No. 07573833

 /MetalcraftUK

 @MetalcraftUK

 /MetalcraftUK

 /MetalcraftUK

 /metalcrafttools