

LOUDERTHANLIFTOFF

# SILVER BULLET mk2 PLUGIN USER MANUAL

Rev. 3



# TABLE OF CONTENTS

<b>INTRODUCTION</b>	<b>4</b>
<b>INSTALLATION</b>	<b>5</b>
System Requirements and Supported Platforms	5
Install and Activate your New Plugin:	5
<b>QUICKSTART – Main Panel</b>	<b>7</b>
<b>QUICKSTART – Aux Panel</b>	<b>9</b>
<b>BLOCK DIAGRAM</b>	<b>10</b>
<b>CONTROL DETAILS</b>	<b>11</b>
<b>MODE Selection</b>	<b>12</b>
POWER	12
POLARITY	12
<b>MOJO Amps</b>	<b>13</b>
MOJO A•N	13
MOJO C / COLOUR	14
Mojo Intensity	14
<b>Tone Shaping (EQ) Section</b>	<b>15</b>
TIGHT High Pass Filter	15
TIGHT Frequency	15
Baxandall TONE EQ	15
VINTAGE Mode	16
ASPECT RATIO	16
<b>Aux Panel</b>	<b>17</b>
Preset Manager	17
GAIN LINK	18
CIRCUIT BEND	18
MOJO C Select	18
DYNA REALISM™	20
DYNA REALISM MODES	21
DEPTH	21
RATE	21
HEADROOM	22
OUTPUT TRIM	22
<b>METERS</b>	<b>22</b>

<b><i>Rear Panel</i></b>	<b>22</b>
<b><i>Void Corp Mode</i></b>	<b>23</b>
<b><i>CREDITS</i></b>	<b>23</b>

# INTRODUCTION

Thank you for purchasing the Silver Bullet mk2 plugin. We are truly grateful for your support here at Louder Than Lifftoff!

It's incredible to think that more than 10 years have passed since Brad McGowan and I embarked on the journey of creating the iconic Silver Bullet, a renowned piece of Audio Outboard Hardware. While both Brad and I come from an analog background, we have wholeheartedly embraced the modern hybrid workflow as the industry standard. When we contemplated the viability of a Silver Bullet plugin, it was essential for us to capture the analog sound while leveraging digital capabilities that surpass what the hardware can offer. We firmly believe that both the hardware Silver Bullet mk2 and its digital counterpart, the Silver Bullet mk2 plugin, have a place in every studio.

As you instantiate the plugin for the first time, prepare to embark on an amazing sonic journey! Each day, I continue to discover new and exciting features that this plugin has to offer. Interestingly, I've found that I interact with the plugin's knobs in a slightly different manner compared to the hardware, leading to enjoyable and often unexpected results!

At the start of this journey, we were concerned about capturing the lifelike and vibrant quality that analog units possess—a sense of depth and dimension that many plugins fail to deliver. So we challenged ourselves to push the state of the art of analog modeling. After extensive discussion and collaboration, we developed a unique and innovative approach called Dyna Realism™ (patent-pending) for generating a user-selectable spectrum of analog realism. This goes beyond the standard approach that typically involves circuit schematics and component level modeling. Behind the seemingly "simple" design of this plugin, there is some intensive code at work. We have implemented some interesting ways to incorporate Dyna Realism™. I encourage you to read about it in this manual and experiment with it. We believe that careful experimentation with Dyna Realism™ will bridge the gap between this plugin and the analog world more effectively than other options available.

Beyond the exceptional Saturation, EQ, Filters, Aspect Ratio, and Harmonic Mojo you would expect from a hardware Silver Bullet, don't forget to explore the Aux Panel for a few unique and unconventional capabilities that are exclusive to the plugin...including a few Easter eggs. Feel free to unleash your creativity, tweak the knobs, and push the boundaries of what you can achieve with this plugin! And, of course, let your creativity flow through your music, which you can share with the rest of our community.

Welcome to the Mission!

William Pearson — aka drBill

# INSTALLATION

## System Requirements and Supported Platforms

For latest system requirements & supported platforms, please visit the product list page on the Plugin Alliance website to see particular details for this product.

## Install and Activate your New Plugin:

For offline activation instructions and additional information, please refer to the Activation Manual (activation\_manual.pdf) included in the installation folder of this plugin. For more information, visit: [www.plugin-alliance.com](http://www.plugin-alliance.com)

### Option #1 – Installation Manager

Plugin Alliance Installation Manager Installation instructions:

1. Run the appropriate installer for your system found in its corresponding folder.

**Mac:** pa\_installation\_manager\_mac\_1\_2\_3.dmg  
**Windows:** InstallationManagerSetup.exe

2. Run the PA Installation Manager application. Create a free Plugin Alliance account if you do not already have one. Log into your account.

3. Search for Silver Bullet mk2 in the product list, select it, and click "Download & Install." This will download and install Silver Bullet mk2 and its preset files.

### Option #2 – Standalone Installers

1. Run the appropriate installer for your system found in its corresponding folder.

**Mac:** "LTL Silver Bullet mk2.app"  
**Windows:** "LTL Silver Bullet mk2.exe"

## Activating Your License

1. Create a free Plugin Alliance account if you do not already have one using this link:

<https://www.plugin-alliance.com/en/registration.html>

2. Redeem the product voucher code you received via email by following the instructions at this link:

<https://www.plugin-alliance.com/en/activate.html>

After the voucher code has been added, please be sure to complete the checkout process. The plugin license will not be added to your account until you click the "Place order" button at the end of the process.

3. Run the Silver Bullet mk2 plugin from inside of any DAW. Follow the activation prompts and login to your Plugin Alliance account from within Silver Bullet mk2. Once this is completed a static license file will be added to your computer and the plugin will work on or offline without having to log in.

# QUICKSTART – Main Panel



**POWER** switch enables processing for the plugin.

**POLARITY** switch reverses polarity of the input signal.

**MODE Selector switch** chooses which sections of the plugin are active for processing. MIX enables all processing. PRE EQ enables only processing before the TONE EQ, up to and including TIGHT. POST TIGHT enables only processing after, but not including TIGHT. Bypassed sections will be grayed out. These two selections effectively split the plugin in half and allow two instances of the Silver Bullet to be placed before and after another plugin in the DAW channel. This workflow emulates the Insert Mode of the hardware (i.e. the other plugin is inserted in the middle of the Silver Bullet's processing).

**MOJO Selector switch** chooses which MOJO amp is processing the signal. Inactive MOJO amp controls are grayed out. The A and N amps may be cascaded for maximum MOJO.

**MOJO A•N switch** engages the A and N amps at the heart of the TONE-AMP™. When engaged, A and/or N LEDs will illuminate to show the active selection.

**MOJO C / COLOUR switch** activates the C Mojo Amp expansion slot, as selected by the MOJO C SELECT drop-down on the Aux Panel. When the “C” module is active, the C LED will illuminate. The LED next to the switch illuminates with a unique color determined by the chosen module.

**GAIN knobs** drive the input of the A and N MOJO stages.

**OUTPUT knobs** attenuate the output level of the A and N MOJO stages.

**SWAP LED** illuminates when MOJO selector is set to N>A.

**C-DRV knob** simultaneously controls both input gain of the C module and post-module attenuation to maintain a musical loudness taper (approximately unity gain). The control goes from -6 dB to +18 dB of drive; the red hashmark denotes 0 dB. The exception is for the Helical Scan Colour module where C-DRV controls the warble depth instead.

**C-MIX knob** controls intensity of C module effect by blending processed and dry signal. Turning the knob clockwise mixes in more of the C module's effect. The exception is for the VHS AF Colour module where C-MIX controls the intensity of warble instead.

**TIGHT switch** engages a 12 dB/oct high pass filter.

**TIGHT Frequency switch** selects between two high pass filter options: 12 dB/oct at 25 Hz with a slight resonant bump at 40 Hz which gives tape-like response for mixes, or 12 dB/oct Butterworth at 50 Hz which is well suit-suited for tracking.

**TONE switch** engages the 3-band Baxandall EQ circuit. The LED illuminates when engaged.

**LF knob** sets the amount of low frequency boost/cut for the Baxandall TONE circuit up to +/- 9 dB.

**LF Selector switch** selects between SUB 1, SUB 2, BASS, and BODY frequencies.

**HF knob** sets the amount of high frequency boost/cut for the Baxandall TONE circuit up to +/- 9 dB.

**HF Selector switch** selects between MIDS, PRES, BRITE, and SHEEN frequencies.

**AIR knob** sets the amount of Air boost/cut circuit up to +/- 9 dB.

**VINTAGE switch** alters high frequency response to emulate vintage British consoles.

**ASPECT RATIO switch** alters the relationship between width and height of the stereo image to give a more enhanced stereo image.

**20 segment meters** show output level of processed signal for all Modes. When the plugin is bypassed no signal will be present.

**Gain Reduction meter** shows gain reduction level for applicable MOJO C modules. It is hidden when not used. Each LED indicates 2 dB of gain reduction.



# QUICKSTART – Aux Panel



**GAIN LINK switch** enables linking between the GAIN and OUT knobs for the A and N MOJO amps for simplified gain-staging. When the switch is pressed the knobs will link at their current settings. Turning up the GAIN turns down the OUT in an inverse manner. Hold down the Option or Alt key while moving the GAIN or OUT knobs to temporarily defeat the Gain Link.

**CIRCUIT BEND Selector switch** selects settings that rewire the digitally modeled analog circuits as if the hardware had been “circuit bent”. BEND 1 and BEND 2 short out power rails in various parts of the processing and produce distorted and broken textures that can be exploited for creative use. A, N, and C MOJO will each exhibit unique behaviors as a function of BEND setting. Exploration is rewarded.

**MOJO C SELECT drop-down** selects which Colour module is active for MOJO C.

**DYNA REALISM™ Selector switch** controls how much left/right channel and unit-to-unit variations occur throughout all circuits in the digital model including Mojo, EQ, and Aspect Ratio. These subtle differences can enhance the depth and width of the stereo image.

**DEPTH knob** sets the amount of amount of analog variation when FLUX is enabled. High settings can cause extreme level and frequency shifts.

**RATE knob** sets the rate at which the FLUX processor varies the digital model. At higher settings a lot of musical variation can be created in a stereo source. The LED next to the knob pulses in sync with the oscillations in both FLUX and BPM modes.

**HEADROOM knob** adjusts the internal operating level so that the plugin produces saturation. Turning the control counterclockwise decreases headroom and increases the amount of saturation from the MOJO amps. Turning the control clockwise increases headroom and decreases the amount of saturation produced by the MOJO amps. There is +/-10 dB of range. The default setting is at 0 (12 o'clock).

**OUT TRIM knob** sets the final output level of the plugin using a digitally modeled gain stage up to +/- 10 dB.

**SILVER BULLET mk2:** Click to access the serial number and credits on the rear panel.

# BLOCK DIAGRAM

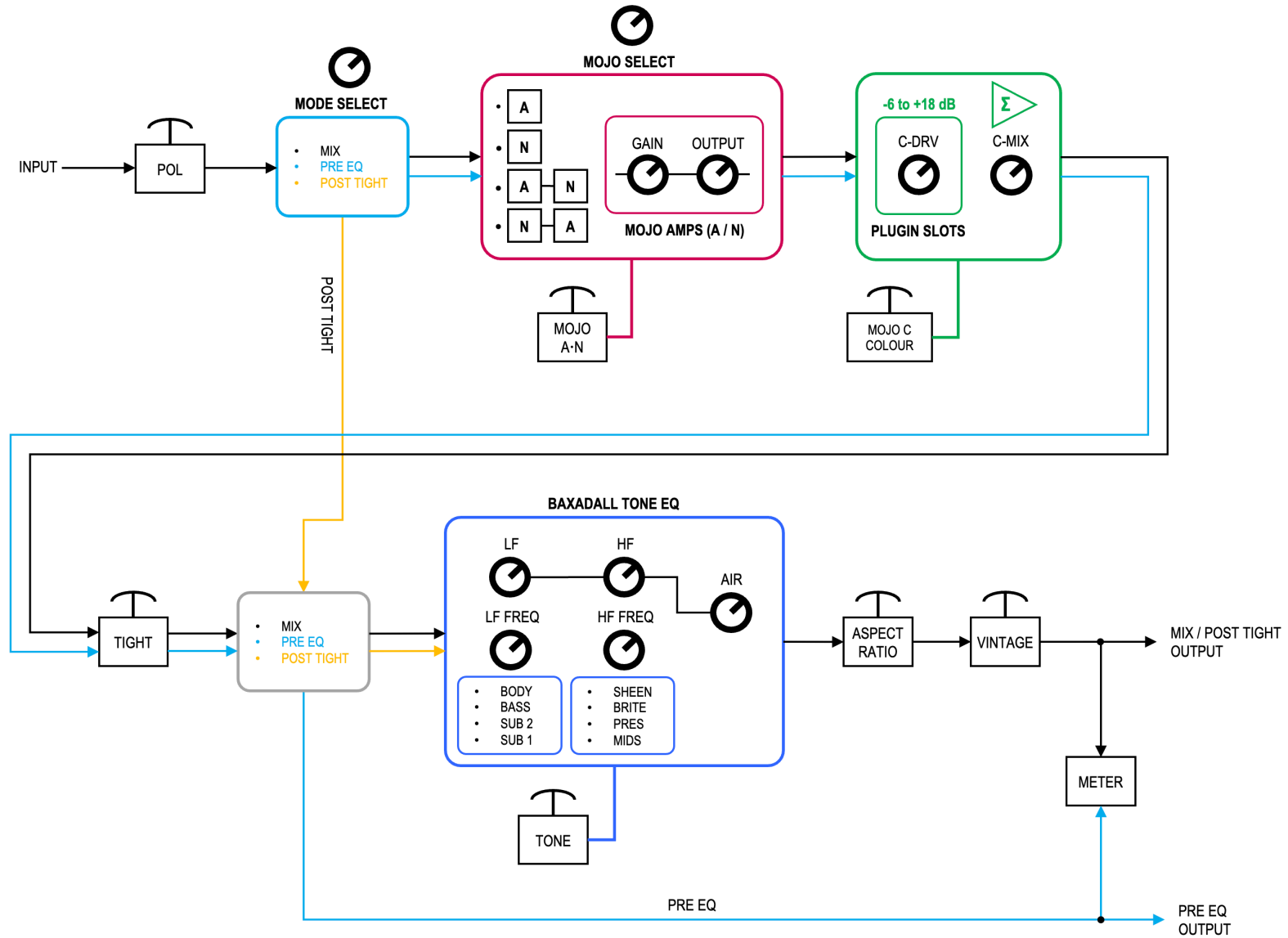

# CONTROL DETAILS

The Silver Bullet mk2 is a true stereo plugin with one common set of controls for both left and right channels when used on stereo audio tracks. Mono instances of the plugin can be used on mono audio tracks within your DAW. All Mojo potentiometers feature 21 detents to facilitate recall. All Tone Shaping potentiometers feature 41 detents.

The Silver Bullet mk2 is comprised of four main sections on the **Main Panel**:

1. **MODE** Selection – facilitates different workflows that allow the plugin to be used in full or split in half so other plugins can be instantiated in between the MOJO and Tone Shaping sections.
2. **MOJO** Amps – impart harmonic distortion, saturation, and analog “mojo”; this section includes a third C Mojo that can be selected from the drop-down on the Aux Panel.
3. **Tone Shaping (EQ)** section – enables you to shape and enhance the tone of the signal.
4. **Aspect Ratio** – musical image enhancement processor.

There is an **Aux Panel** with additional functions that expand the capability of the digital model beyond what the analog hardware could do:

1. **Preset Manager** – A, B, C, D buttons allow you to toggle between four preset settings. The drop-down menu has options to load/save presets, resize/reset the GUI window, disable tooltips, and save/reset the Serial Number on the rear panel.
2. **Gain Link** – inversely links the GAIN and OUT knobs for each of the three Mojo Amps for unity gain control.
3. **Circuit Bend** – breaks the digital model of the Mojo Amps to emulate hardware circuit bending.
4. **MOJO C Select** – choose different Colour module emulations to load into MOJO C.
5. **Dyna Realism™** – analog realism modes that add increasingly greater static and dynamic stereo variation to the digital model (patent-pending).
6. **Depth** – sets the amount of amount of analog variation when FLUX is enabled.
7. **Rate** – sets the rate at which the FLUX processor varies the digital model.
8. **Headroom** – adjusts the internal operating level so that the plugin produces saturation.
9. **Output Trim** – sets the final output level of the plugin.

# MODE Selection

The MODE Selector Switch controls which sections of the plugin can be activated. The signal flow for each Mode is best understood by referencing the Block Diagram and Signal Flow / Routing Diagram above.

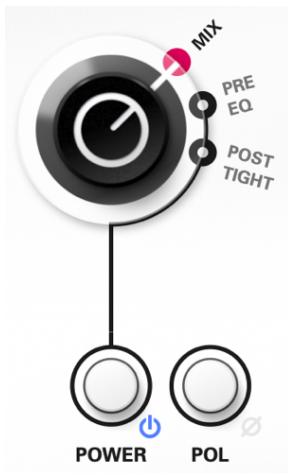

MIX mode allows all processing blocks of the plug to be enabled. This is the default mode.

PRE EQ enables all MOJO and TIGHT filter processing only. The Tone Shaping EQ, VINTAGE Filter, and ASPECT RATIO are disabled. Their controls will be grayed out.

POST TIGHT enables Tone Shaping EQ, VINTAGE Filter, and ASPECT RATIO only. The three MOJO Modules, and TIGHT Filter are disabled. Their controls will be grayed out.

Using the PRE EQ and POST TIGHT modes provides a convenient way to for other plugins to be inserted virtually into the middle of the Silver Bullet's signal path between the TIGHT filter and the Tone Shaping EQ. This is analogous to using the inserts on the hardware unit. For example, if you wanted to use a compressor plugin in the middle of the Silver Bullet, you would set up the following three plugin instances in your DAW:

SILVER BULLET mk2 (Mode = PRE EQ) → Compressor Plugin → SILVER BULLET mk2 (Mode = POST TIGHT)

## POWER

This button enables or bypasses all plugin processing. When the plugin is enabled the LED illuminates blue. When the plugin is bypassed using this switch all controls will be grayed out and the meter will stop indicating output level.

## POLARITY

The POL switch reverses the polarity of the input signals. If the plugin is a stereo instance, then both left and right input signals are reversed. When mixing drums, it's a good practice to check the polarity of all sources against each other so that you have a full and punchy low end.

# MOJO Amps

The MOJO section is the heart of the unit. The A and N MOJO Amps are modeled after the exact circuits used in the original Silver Bullet mk1 and Silver Bullet mk2. A third Mojo Amp has been added in series with these for even more tonal flexibility and nuance. The C Mojo Amp can be customized by selecting virtual Colour Modules from the drop-down menu on the Aux Panel.

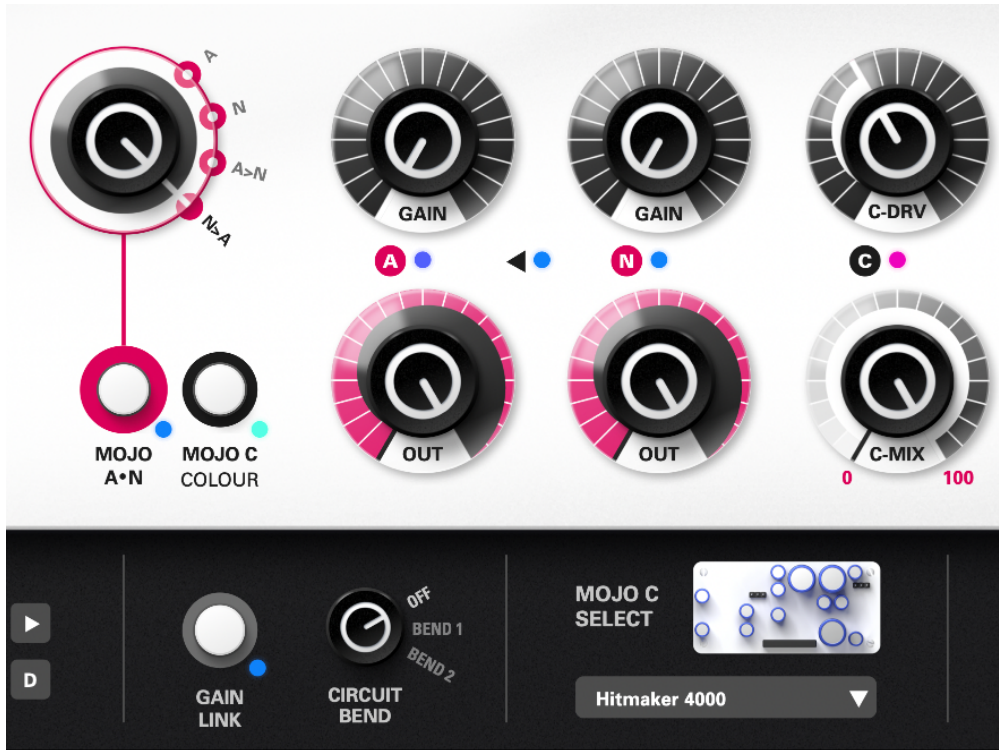

## MOJO A•N

To activate either or both A/N MOJO Amps press the MOJO A•N pushbutton switch. The active Amps will be indicated by the Mojo LED labelled “A” or “N”. The active MOJO Amp or cascaded combination of Amps is selected with the rotary MOJO Selector switch. You can choose to use just one Amp, or both A and N Amps in series. The fourth setting swaps the serial order; the “SWAP” LED will illuminate to indicate this setting.

The GAIN and OUT controls each provide 24 dB of gain. In either the A>N or N>A cascaded selections, up to 48 dB of gain is available. Needless to say, that's a crap-ton of gain to use on a full mix. The potential to completely mangle program material into sonic soup is high when both GAIN and OUT are at maximum. Unity gain is always approximately achieved by setting GAIN and OUT to mirrored settings. For example, GAIN at 9 o'clock, and OUT at 3 o'clock will be close to unity gain. GAIN at 1 o'clock and OUT at 11 o'clock will also yield an output close to unity gain. Use the meters for reference and fine tune the OUT to taste. GAIN LINK on the Aux Panel is enabled by default to help automatically gain stage in this manner (see the section below).

The output level of each MOJO Amp channel is calibrated for unity gain when the GAIN is set to minimum, and the OUT is set the maximum. This ensures well-matched left/right channel gain and a balanced stereo image. Double click the GAIN or OUT knobs to reset them to their min and max settings respectively.

## MOJO C / COLOUR

To activate the Colour Module selected from drop-down on the Aux Panel, press the MOJO C / COLOUR pushbutton switch. An RGB Colour LED next to it illuminates when the MOJO C / COLOUR pushbutton is engaged. The “C” Mojo LED will also illuminate. The LED color is dependent on the module selected—each module will have a unique hue to help identify it.

The C-DRV knob provides -6 to +18 dB of input drive. The red hash mark denotes unity gain. It simultaneously increases input gain into the module and attenuates the output level so that there is only a small increase in RMS gain throughout the range of the knob. The overall feel is very musical and intuitive: as C-DRV is turned up the RMS level increases slightly while peak levels are attenuated. This can be seen on the meter. Depending on the module installed, this control will affect the amount of saturation, distortion, or compression.

The C-MIX knob allows the user to blend the MOJO C / COLOUR effected signal with the signal taken before MOJO C and post A/N MOJO. Setting the knob fully counterclockwise at “0” will give only the “dry” signal. Setting the knob fully clockwise at “100” will give only the effected signal. This allows one to fine-tune the intensity of the effect, or to achieve parallel compression depending on what’s installed in the expansion slot.

## Mojo Intensity

Control Right clicking the C-MIX knob or text will transform the C-MIX knob into a Mojo Intensity control for the entire A>N>C Mojo signal path. In this mode the dry signal is taken before the A•N MOJO section, but after POLARITY. This allows you to lower the intensity of the entire chain of saturation by blending in dry signal when C-MIX is turned down.

Note: when VHS AF is selected for MOJO C the warble intensity will be set to a tasteful preset amount in this special mode.

## Mojo LEDs – A, N, C

The LEDs for the A, N, and C MOJO Amps illuminate blue when the corresponding MOJO switch is engaged, and rotary MOJO Selector switch is set. If the N>A setting is selected the SWAP LED will illuminate as well to indicate the signal is flowing into the N Amp before the A Amp. To help gauge the level of saturation in each MOJO Amp the blue LEDs will turn pink and then red as the Gain knob is turned up. When the LEDs turn red the audio will probably sound severely mangled.

## GR LED

This RGB LED indicates Gain Reduction for C Mojo Modules that offer compression or limiting. The different colors correspond to the following levels of gain reduction:

- Blue = 0-2 dB
- Green = 2-4 dB
- Yellow = 4-6 dB
- Red = >6 dB

# Tone Shaping (EQ) Section

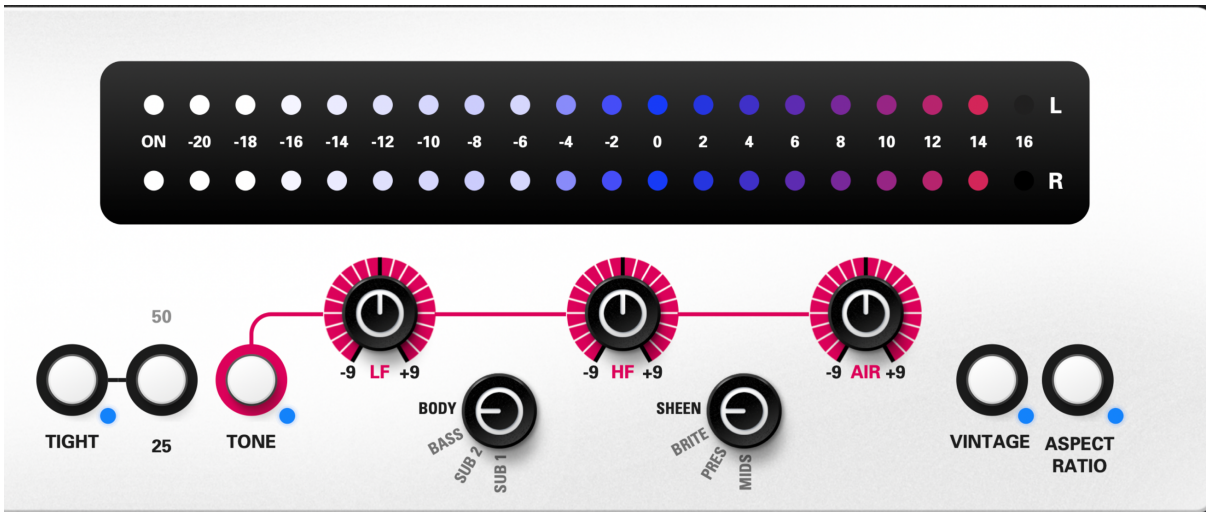

## TIGHT High Pass Filter

Engage the TIGHT pushbutton switch to activate a 12 dB/oct high pass filter with a corner frequency (-3 dB) at 20 Hz. The filter is slightly resonant so there will also be a tasteful 0.6 dB bump at 40 Hz. TIGHT works well for clearing up subsonic mud that can reduce headroom in a mix without adversely affecting the perception of low-end size and extension. This feature can be used in conjunction with or separately from all other processing.

## TIGHT Frequency

The pushbutton next to TIGHT selects between the original Silver Bullet TIGHT corner frequency and an alternate setting that is better suited for tracking individual instruments. Engage this switch to active a 12 dB/oct Butterworth response high pass filter with a corner frequency at 50 Hz.

## Baxandall TONE EQ

Engage the TONE pushbutton switch to insert the 3-band Baxandall EQ into the signal path. The LED next to the pushbutton will illuminate blue to indicate that the EQ is activated. The left knob controls the amount of boost or cut for the Low Frequency (LF) shelf. The rotary switch to its right selects between four frequency settings: SUB (30 Hz), SUB (45 Hz), BASS (60 Hz), and BODY. The middle knob controls the amount of boost or cut for the High Frequency (HF) shelf. The rotary switch to its right selects between four frequency settings: MIDS, PRESENCE, BRITE, and SHEEN. The right knob controls the amount of boost or cut for the AIR shelving filter. The amount of boost/cut for each band is +/- 9 dB.

The LF and HF bands each have four (4) frequencies that can be selected by rotary frequency selector knobs. The frequency values increase as the knob is turned clockwise. The lowest frequency is the choice at 6 o'clock on the selector switch. The AIR band has two (2) frequencies that can be selected by right clicking the knob or "AIR" label. The text will change to blue when the lower 30 kHz corner frequency is selected.

**LF:** SUB 1 (30 Hz), SUB 2 (45 Hz), BASS (60 Hz), BODY

**HF:** MIDS, PRESENCE, BRITE, SHEEN

**AIR:** The original Air band from the Silver Bullet mk1 is the default setting (red text). An alternate lower frequency option (blue text) is available via internal jumper on the hardware Silver Bullet mk2, but we made it accessible on the plugin by right clicking the knob. This band technically occurs in series with the LF and HF bands, so it can be used to create some amazingly smooth high frequency filter shapes. You can

The boost/cut gain knobs all have 41 detents for precise recall.

Because the TONE EQ can be engaged separately from all other processing, the Silver Bullet mk2 can be used just for its tone shaping capabilities if desired.

## Designer's Note

The Silver Bullet mk2 EQ is the evolution of the original Silver Bullet 2-band EQ. While extremely musical and smooth, it was limited in its frequency options. The new EQ doubles the number of frequency selections in the LF and HF bands and splits off the beloved AIR setting to its own dedicated control. It can now be used in conjunction with other HF settings to tailor the top end of your tracks and mixes in ways other EQs just can't touch.

## VINTAGE Mode

Engage the VINTAGE pushbutton switch to apply a 6 dB/oct low pass filter to the extreme high frequencies. One of the trademark characteristics of vintage Neve consoles is the soft and silky top end, especially when the EQ is engaged in the channel. The VINTAGE switch applies this characteristic coloration to the signal path. When combined with the high shelves of the TONE section, unique equalization curves can be created to expand the palette of treble tone shaping possibilities.

Like the TIGHT filter and Baxandall TONE EQ, VINTAGE can be used independently from the MOJO Amps. The plot in the TIGHT section above shows the frequency response of VINTAGE Mode without the Baxandall TONE EQ engaged.

## ASPECT RATIO

ASPECT RATIO is a proprietary analog processor that musically enhances the stereo width, height, and clarity of your mix. This isn't one of those cheap sounding, phasey widening effects that leaves you wondering if you are messing up your soundstage or balance. ASPECT RATIO delivers masterful results at the touch of a single button. No fussy tweaking or second guessing required. We spent the last year perfecting this circuit so you can get on with perfecting your mix.



# Aux Panel

The controls on this lower panel provide additional functionality that goes beyond the capability of the original hardware unit. Presets and gain staging can be managed, but there are also controls that invite the user on a journey of sonic discovery of new creative textures.



## Preset Manager

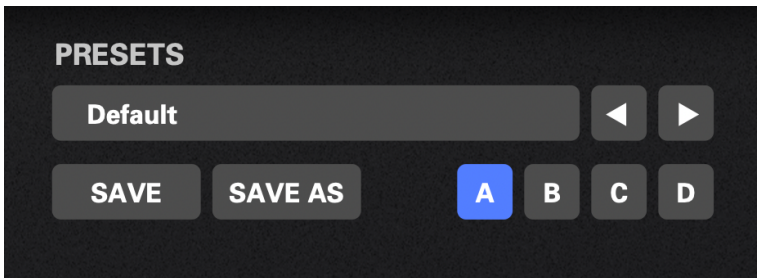

The drop-down menu has options to load/save presets, resize/reset the GUI window, disable tooltips, and save/reset the Serial Number on the rear panel. The A, B, C, D buttons allow you to toggle between four preset settings per plugin instance for the active session. The right and left arrows scroll through preset options.

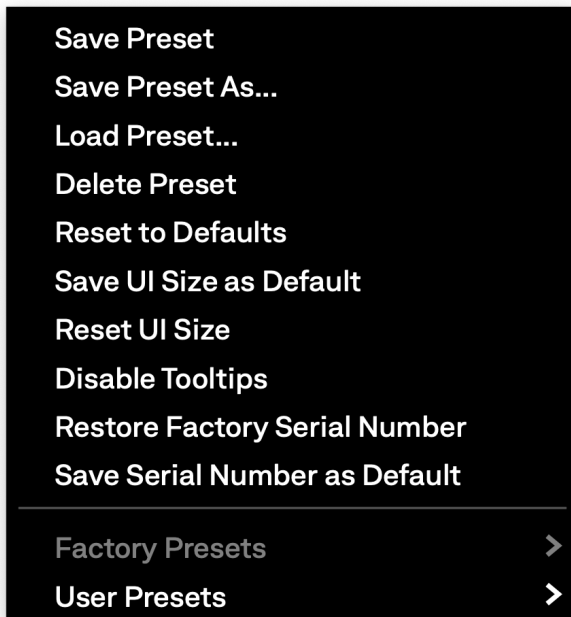

- **Save Preset:** overwrites active preset with current settings.
- **Save Preset As:** saves current settings to a new preset.
- **Load Preset:** loads the settings from a saved User Preset.
- **Delete Preset:** removes the active preset from the User Presets bank.
- **Reset to Defaults:** resets all knobs, switches, and buttons to the default settings.

- **Save UI Size as Default:** click to save the plugin window size as default after you expand its size by dragging the lower right corner.
- **Reset UI Size:** resets the plugin window to 1366 x 381 pixels.
- **Disable Tooltips:** hide pop-up tooltips from showing when you hover the mouse cursor over a control.
- **Restore Factory Serial Number:** click this option to restore the serial number to the one originally assigned to your user license. Note that this option only appears once the serial number has been changed on the rear panel.
- **Save Serial Number as Default:** after typing in a new serial number on the rear panel you may click this option to save it as the new default for the plugin.

## GAIN LINK

This pushbutton enables linking between the GAIN and OUT knobs for the A and N MOJO amps for simplified gain-staging. When the switch is pressed the knobs will link at their current settings. Turning up the GAIN turns down the OUTPUT in an inverse manner. Hold down the Option or Alt key while moving the GAIN or OUT knobs to temporarily defeat the Gain Link.

## CIRCUIT BEND

The CIRCUIT BEND rotary switch selects settings that rewire the digitally modeled circuits as if the hardware had been “circuit bent”. BEND 1 and BEND 2 short out power rails in various parts of the processing and produce distorted and broken textures that can be exploited for creative use. BEND 2 tends to produce more intense and obtrusive results. A, N, and C MOJO will each exhibit unique behaviors as a function of BEND setting. Exploration is rewarded.

Note: when CIRCUIT BEND is enabled for the Helical Scan Colour, there will be a low-level droning buzz. This is an intended behavior for that combination of modes.

## MOJO C Select

This drop-down menu selects which Colour module is active for MOJO C:

- **Hitmaker 4000:** modeled after the Louder Than Liftoff Colour module of the same name and produces analog saturation inspired by classic VCA recording consoles from the 1980’s

### drBill’s Note

The sound of early sampling 12-bit drum machines—the 12 and subsequently the 1200 became an iconic part of “my sound” in the late 80’s and early 90’s. The digital recording mediums improved quickly and dramatically, but there was always something “organically digital” about the 12/1200 samplers. I love that a bit—or 12—of that character coupled with the console of the day has found its way into the mk2 plugin. Enjoy the destruction.

- **Bitmaker 1200:** 12-bit, sample rate reduced version of Hitmaker 4000 with brick wall input filtering and aliasing artifacts inspired by a legendary late-80’s sampling drum machine.

- **Vinyl Saturation (designed by Unfiltered Audio):** produces warm vinyl saturation based on their plugin Needlepoint.
- **Helical Scan (designed by Unfiltered Audio):** features VHS tape inspired warble algorithms based on their plugin LO-FI-AF. Turning up C-DRV increases the depth and intensity of the pitch variations. Turning down C-MIX from 100 will blend warble and dry signals to create a chorusing effect. At full C-MIX = 100 the wet signal is delayed 8 ms from the dry signal. At all other C-MIX settings the wet signal is delayed 20 ms. These delay times are not delay compensated by your DAW so if maintaining the track's timing is important to you then you will need to adjust track delay manually in your DAW.
- **VHS AF (designed by Unfiltered Audio):** a serial combination of vinyl saturation and VHS warble algorithms that increase saturation intensity as C-DRV is turned up and increase warble depth as C-MIX is turned up.

## Designer's Note

When I started my recording journey in the mid-1990's I was primarily using a Tascam Portastudio cassette 4-track. I discovered that I could mix down to the audio inputs of my family's VHS video recorder and bounce the stereo mix to a fresh cassette tape to get an additional two tracks...six tracks in total. Helical Scan and VHS AF Colour modules evoke the nostalgic sounds of those two marginally stable and lo-fi recording systems that I relied upon for my early productions.

## DYNA REALISM™

The Silver Bullet mk2 plugin is more than just an analog emulation of an acclaimed hardware unit. It's an exploration of the question "what is analog"? To answer that question, we created Dyna Realism, our remarkable patent-pending analog realism generator. Dyna Realism harnesses the innovative Virtual Parts Bin and Serial Number systems, meticulously constructing unique static and dynamic models of analog circuits across a broad spectrum of variation and realism. Through a simple knob adjustment, each setting unveils more intense variations within and between channels. Experience cutting-edge analog realism modeling. It breathes life into static emulations, surpassing their inherent limitations to deliver hyper-real dynamic emulations where the circuits feel alive.

### Virtual Parts Bin™

Critical circuit components driving channel to channel variation in real hardware units have been painstakingly measured and cataloged into Virtual Parts Bins. This means that when you instantiate the plugin, you receive a "built-to-order" version of the analog emulation, assembled using discrete components selected from the Virtual Parts Bin and associated to your license.

### Serial Number

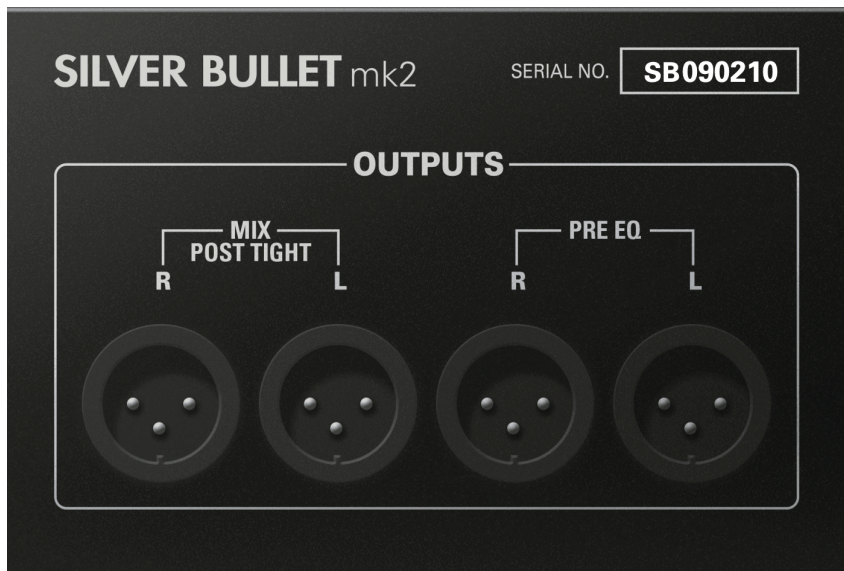

Click the SILVER BULLET mk2 logo on the right side of the Aux Panel to reveal the rear panel and you will see a serial number. The six-digit serial number on the rear panel is not just for graphical authenticity, however. These six digits serve an integral function to the Virtual Parts Bin system and Dyna Realism modes. Just like a real hardware unit, each license of the plugin is given a unique serial number. That serial number identifies a unique build of the digitally modeled analog circuit.

Every time you instantiate a new instance you will get the same serial number. By changing your serial number on the rear panel, you can explore other subtly unique builds. Imagine coming to our factory and choosing your unit from a 1000 different hardware Silver Bullets. Simply type a new six-digit number into the field and you have a new unit at your disposal. The DYNA REALISM modes yield processing variations unique to each serial number just like one would experience with individual hardware units.

If you'd like to save this new serial number as your default, you can do that on the plugin's Preset Menu. You can also revert to your factory provided serial number as well.

## DYNA REALISM MODES



The DYNA REALISM Mode Selector switch sets how much left/right channel, and unit-to-unit variations occur throughout all circuits in the digital model including Mojo, EQ, and Aspect Ratio by choosing component values from the appropriate Virtual Parts Bin. These subtle differences can enhance the depth and width of the stereo image.

- **SYM (Symmetric):** has the most amount of left/right symmetry because it uses identical digital models on both the left and right channels of a stereo instance. In other words, it has the least left/right channel variation throughout all circuits. The Mojo section potentiometers use actual measured pot values with realistic and uneven detent spacing. C-MIX also uses measured detent spacings but has a more idealized left/right tracking for wet/dry mix. The EQ, however, uses idealized potentiometers with evenly spaced 0.45 dB steps between detents, which is helpful for mastering applications when maintaining a perfect left/right image is desired. Frequency response between channels in a stereo instance will be well matched. Note: this mode is still giving you a realistic analog emulation just with less stereo variation than other modes.
- **ANLG 1 (Analog 1):** is the closest to the real hardware unit we modeled. There is variation between individual potentiometer gangs and detents throughout the model. The C-MIX potentiometer more accurately represents stereo imbalances in the wet/dry mix. There can be stereo frequency response variation between channels in the EQ due to different resistances at each pot detent. This is the default mode for the plugin.
- **ANLG 2 (Analog 2):** is less subtle than ANLG1 and uses components from “B-stock” Virtual Parts Bins for some components. The stereo variation between channels is more exaggerated and can be reminiscent of an out of spec hardware unit.
- **FLUX:** allows all these variations to be animated in a randomized, but musical way as if the circuits themselves are moving with the music. The DEPTH and RATE knobs are activated when FLUX is enabled. There is an LED to visual timing.
- **SYNC:** is a FLUX enabled mode that syncs the RATE to the DAW tempo. Circuit variations occur at musical multiples of the set tempo. The RATE knob is disabled in this mode, but the LED will still be active for visual reference of tempo sync.

## DEPTH

The DEPTH knob sets the amount of amount of analog variation when FLUX is enabled. High settings can cause extreme level and frequency shifts.

## RATE

The RATE knob sets the rate at which the FLUX processor varies the analog model. At higher settings a lot of musical variation can be created in a stereo source. The LED next to the knob pulses in sync with the variations in both FLUX and BPM modes. A blue pulse is punctuated with a change to red at the maximum amplitude of each cycle to help emphasize the timing visually.

# HEADROOM

The HEADROOM knob adjusts the internal operating level so that the plugin produces saturation. Turning the control counterclockwise decreases headroom and increases the amount of saturation from the MOJO amps. Turning the control clockwise increases headroom and decreases the amount of saturation produced by the MOJO amps. There is +10 dB of range. The default setting at 0 (12 o'clock) matches the internal gain staging to the hardware we modeled when converters calibrated for -18 dBFS = 0 dBVU = 1.23 VAC.

# OUTPUT TRIM

The OUT TRIM knob sets the final output level of the plugin using an analog modeled gain stage. Up to +/- 10 dB of gain is available. Unlike a simple digital gain stage, this output stage behaves like other analog circuits in the plugin and clips more musically.

# METERS

The stereo meter provides modified PPM ballistics to give visual indication of average levels and loudness on full mixes, while also registering transients with a floating peak LED. The meter is marked with a dBVU scale where 0 dBVU is equal to -18 dBFS. Keep your output levels from hitting +16 on the Silver Bullet mk2's meter and you'll likely avoid clipping your converters. Signals over +16 dBVU will trigger an "over" where the +16 LED will flash for a couple seconds to warn of potential clipping.

The signal feeding the meters is always taken at the output of all processing. It monitors the signal level of the active Mode. Note that no signal will be present on the meters in bypass (POWER button disengaged). For mono signals the meter will only illuminate on the Left side, including the "ON" LED. For stereo signals both Left and Right sides will be used.

# Rear Panel

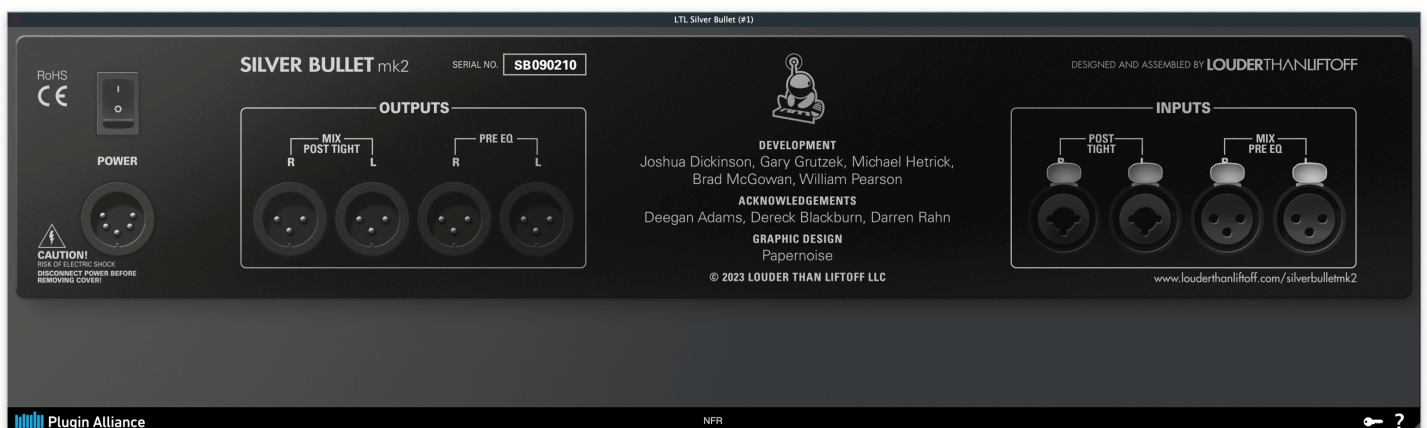

Click the SILVER BULLET mk2 logo on the right side of the Aux Panel to see the credits and Serial Number on the rear panel. As mentioned above, you may type in a new six-digit number to have the new Dyna Realism generator create a new unique build of the model for you.

# Void Corp Mode

Double click the Spaceman logo on the left side of the Main Panel to enable Void Corp mode. The color scheme of the plugin changes to the black faceplate used on Void Corp Edition Silver Bullet mk2 hardware units. All other features of the plugin remain the same.

## CREDITS

The Silver Bullet mk2 plugin is the collaborative work of a team of talented and dedicated music lovers over the course of many years. The concept for the original Silver Bullet hardware began in 2013 and was launched as a product in 2014. This evolved into the Silver Bullet mk2 which was released in 2021. The following people contributed to creating this badass digital version of the Silver Bullet mk2:

Joshua Dickinson  
Gary Grutzek  
Michael Hetrick  
Brad McGowan  
William “drBill” Pearson

### Graphic Design

[Papernoise](#)

### Acknowledgements / Presets contributed by:

DMA - [Deegan Mack Adams](#)  
QH - [Dereck Blackburn](#) / [Quiethouse Recording](#)  
BG - [Benny Grotto](#) / [Mad Oak Studios](#)  
DR - [Darren Rahn](#)

©2023 Louder Than Liff LLC. All rights reserved.

Please use this plugin to make music that you share with the galaxy.

