

**BELFORNO**  
WOOD-FIRED PIZZA OVENS

# Patio Ovens

DESIGNED AND ENGINEERED IN ITALY



Grande 100 model shown in Vintage Pistachio with optional glass door

## INTRODUCING OUR NEW WOOD-FIRED PATIO OVENS FOR YOUR BACKYARD

- = Cooks up to four 10" pizzas in just two minutes - perfect for a fun family night or a gathering with friends
- = Engineered to provide professional results
- = Weather-resistant, powder-coated steel exterior stands up to the elements
- = No structural changes to your property required
- = Available in countertop or portable models
- = Also available in natural gas or propane-fired

## OFFERED IN SIX STYLISH COLORS



VINTAGE SKY



VINTAGE LINEN



VINTAGE PISTACHIO



CLASSIC BLACK



CLASSIC RED



CLASSIC COPPER

*A passion for pizza & Italian quality*



# PRODUCT DETAILS

## WOOD-FIRED PATIO OVENS

### *Piccolo 60*

TWO PIZZAS

PORTABLE

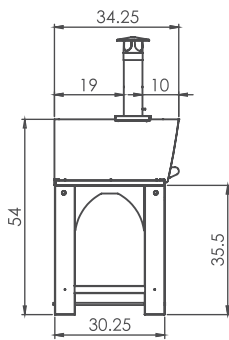
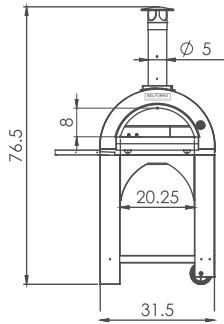

PRICE: \$2,695  
WEIGHT: 286 lbs.

COUNTERTOP

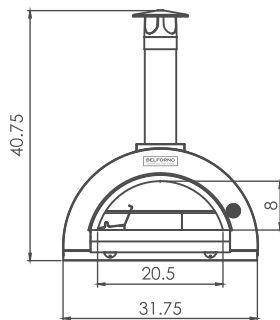

PRICE: \$2,295  
WEIGHT: 209 lbs.

### *Medio 80*

THREE PIZZAS

PORTABLE

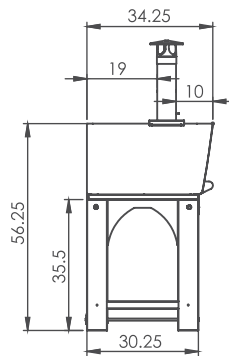
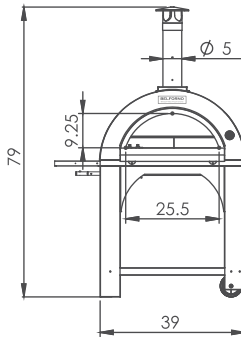

PRICE: \$3,595  
WEIGHT: 345 lbs.

COUNTERTOP

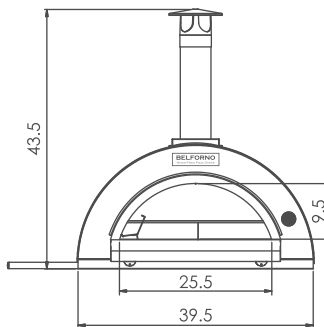

PRICE: \$3,195  
WEIGHT: 246 lbs.

### *Grande 100*

FOUR PIZZAS

PORTABLE

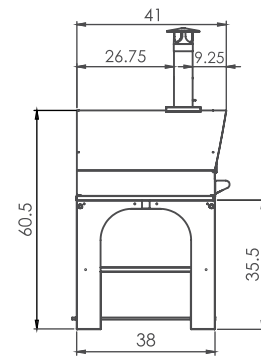
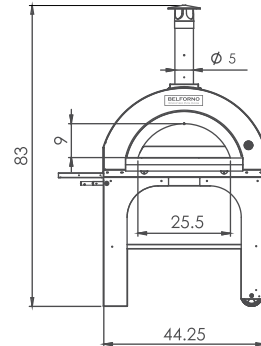

PRICE: \$4,495  
WEIGHT: 605 lbs.

COUNTERTOP

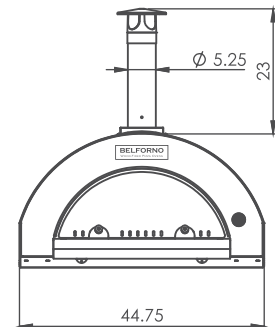

PRICE: \$4,095  
WEIGHT: 506 lbs.