

**BELFORNO**  
WOOD-FIRED PIZZA OVENS

# Patio Ovens

DESIGNED AND ENGINEERED IN ITALY



Grande 100 model shown in Vintage Sky  
with optional glass door

## INTRODUCING OUR NEW GAS-FIRED PATIO OVENS FOR YOUR BACKYARD

- = Cooks up to four 10" pizzas in just two minutes - perfect for a fun family night or a gathering with friends
- = Engineered to provide professional results
- = Weather-resistant, powder-coated steel exterior stands up to the elements
- = No structural changes to your property required
- = Available in countertop or portable models
- = Also available in wood-fired

## OFFERED IN SIX STYLISH COLORS



VINTAGE  
SKY



VINTAGE  
LINEN



VINTAGE  
PISTACHIO



CLASSIC  
BLACK



CLASSIC  
RED



CLASSIC  
COPPER

*A passion for pizza & Italian quality*



# PRODUCT DETAILS

## GAS-FIRED PATIO OVENS

AVAILABLE IN NATURAL GAS OR PROPANE-FIRED

### *Piccolo 60*

TWO PIZZAS

PORTABLE

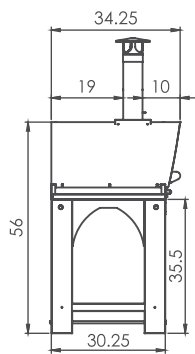
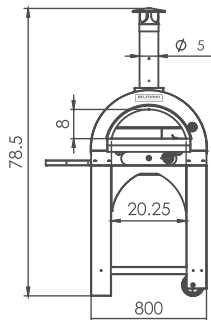

PRICE: \$3,495  
WEIGHT: 330 lbs.  
BTU: 51,182

COUNTERTOP

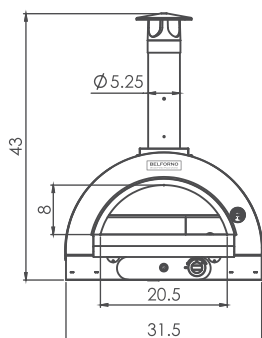

PRICE: \$3,095  
WEIGHT: 253 lbs.  
BTU: 51,182

### *Medio 80*

THREE PIZZAS

PORTABLE

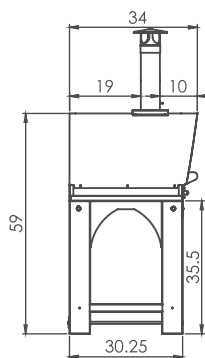
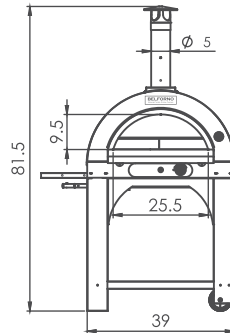

PRICE: \$4,395  
WEIGHT: 418 lbs.  
BTU: 51,182

COUNTERTOP

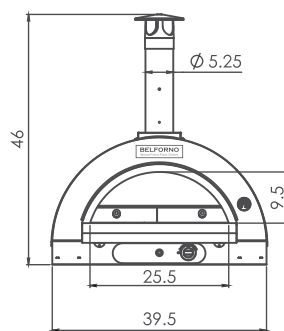

PRICE: \$3,995  
WEIGHT: 297 lbs.  
BTU: 51,182

### *Grande 100*

FOUR PIZZAS

PORTABLE

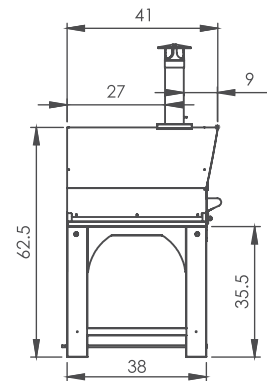
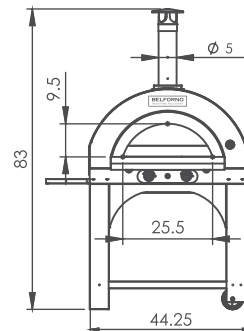

PRICE: \$6,095  
WEIGHT: 649 lbs.  
BTU: 102,364

COUNTERTOP

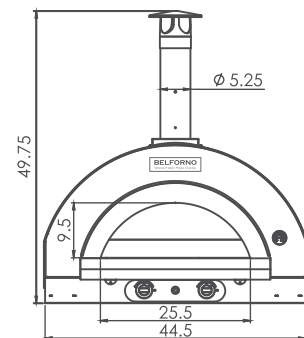

PRICE: \$5,695  
WEIGHT: 529 lbs.  
BTU: 102,364