

Dekala LightFlow™ Smart Linkable Neon Rope Lights

(SLS02-0528)

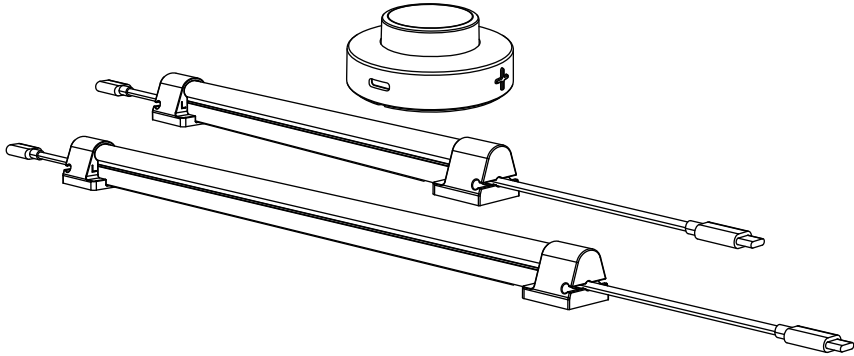

User Instructions

Please read the instructions carefully before use and keep it with proper storage
(V1.0)



Download App



Instruction Videos

Support@dekalastore.com

if you need any assistance please feel free to contact us

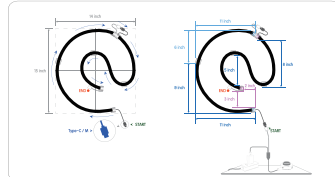
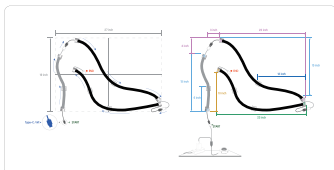
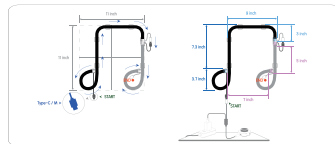
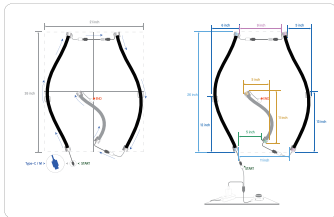
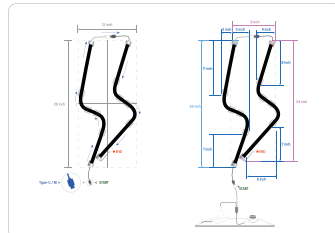
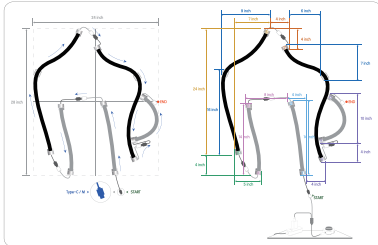
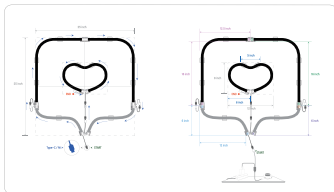
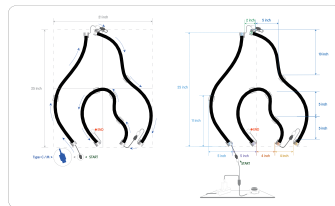
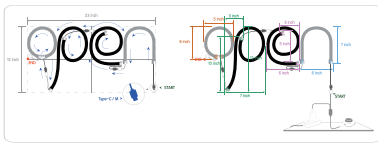

Scan QR Code to Get DIY Guide for More Shapes

Product Features

With gradient technology and flexible design, Dekala LightFlow™ linkable gradient lightstrip offers a powerful blend of colorful light in any shape for any decoration. It can be controlled via controller, app and vocal assistants such as Alexa or Google Assistance. LightFlow™ can be shaped any way you want, bringing new levels of lighting design and creativity.



16 Million Colors



App Control



Voice Control



Sync with Music



9 Gradient Scene



Easy To Link



Take Any Shape



Adjustable Brightness



Adjustable Speed



Wake-up Light

Safety Instructions

READ AND FOLLOW ALL SAFETY INSTRUCTIONS.

1. Please use Dekala original plug to ensure offering safe power.
2. It is not waterproof. Do not mount or place near water or outdoor use.
3. Do not mount or place near gas or electric heaters, fireplaces, candles, or other similar sources of heat.
4. This is an electric product — not a toy! It should not be played with or placed where small children can reach it.
5. The LED light is not replaceable. When the light is damaged, the entire light strip should be replaced.
6. This light strip can not be cut, otherwise it will cause a short circuit or unstable performance.
7. Do not cover the product with cloth, paper, or any material not part of the product when in use.
8. Do not place near flammable objects.
9. Unplug the product when leaving the house, or when retiring for the night, or if left unattended.

Package List

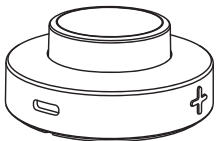

Controller *1

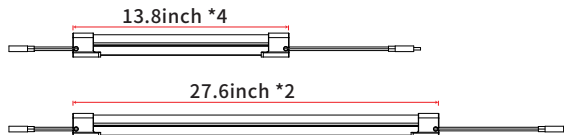

Smart Light Strip *6

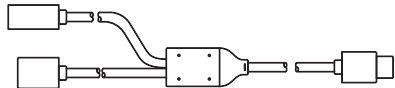

3in1 Charging Cable *1

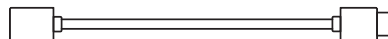

Type-C M/F Extension Cable*3

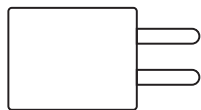

5V-2A Adapter *1

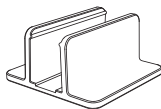

Mounting Clip *8



3M Sticker *2

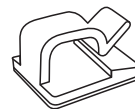

Cable Clip *10

Controller

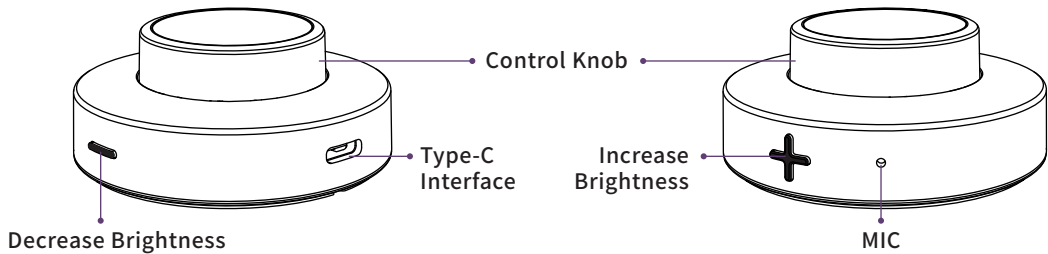

Note: Turn control knob to adjust lighting speed. Press control knob to toggle lighting effect.

Light Strip

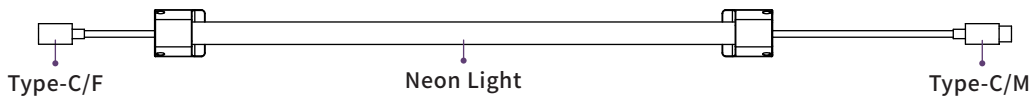







Controller Parameter

Model	SLS Pro-002	Materials	ABS
Size	61×60×35mm	Weight	29g
Color	Black	Input Power	5V-2A
Input Interface	Type-C	WiFi Connection	Bluetooth + 2.4G WiFi (Do not support 5G)

Light Strip Parameter

Model	SLS02-0528
Color	White
Length	9.2ft/2.8m
Input Interface	Type-C/M
Output Interface	Type-C/F
Control	Controller + App + Voice
RGBIC Lamp	168 pieces
Ra	Ra>80

Certification	      
---------------	---

Physical Setup

Take the "lightning" pattern as an example. Unit: inch

① Clean the wall for 3M sticker. Set the Type-C/M end of the light strip down for connecting power. Refer to guidelines to shape light strip position.

② Peel off sticker paper to stick on the wall.

Scan QR Code to Get
DIY Guide for More Shapes

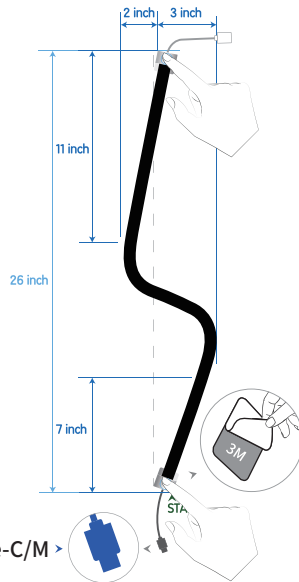
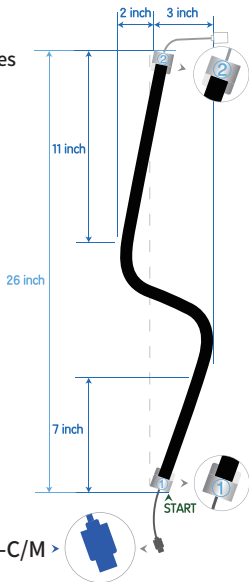

Note: Before sticking, please plan the power connection position. The end of type-C/M is using for connecting to power.

③ Choose right positions of the mounting clips on the surface to fix light strip.

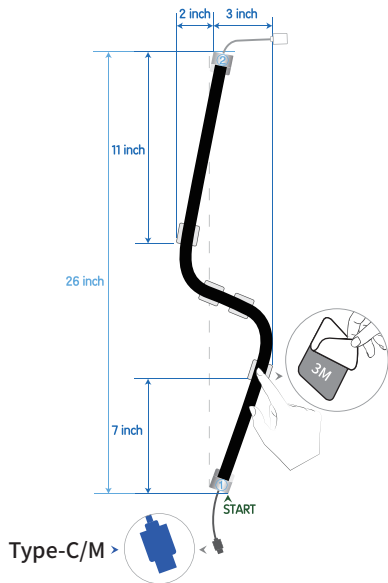

④ Place the other light strip. Please note that "Light strips connecting distance no more than 9 inches."

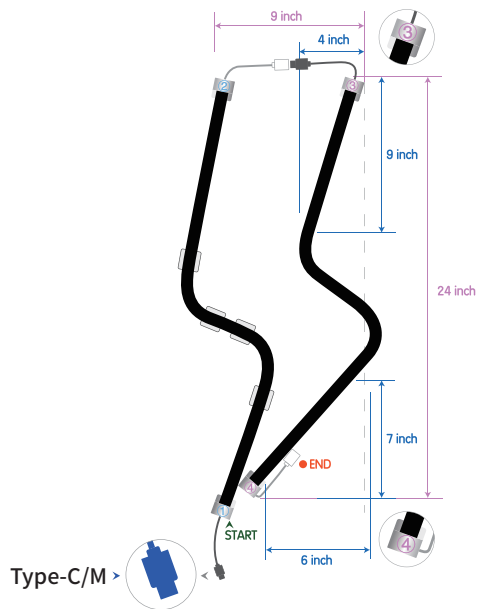

⑤ Choose right positions of the mounting clips on the surface to fix light strip.

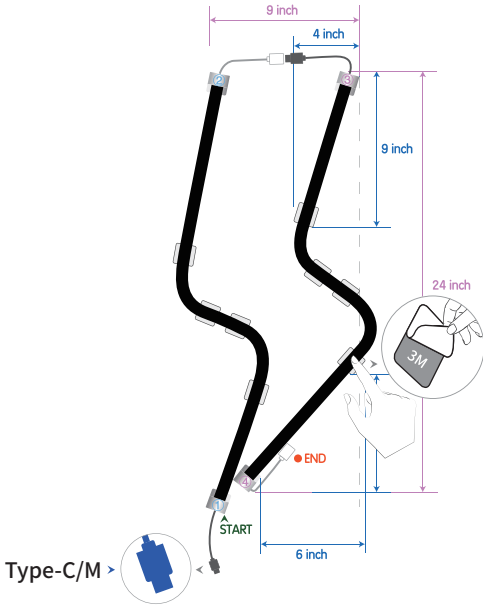

⑥ Use the provided adhesive cable clips to keep the lead cable steady and organized.

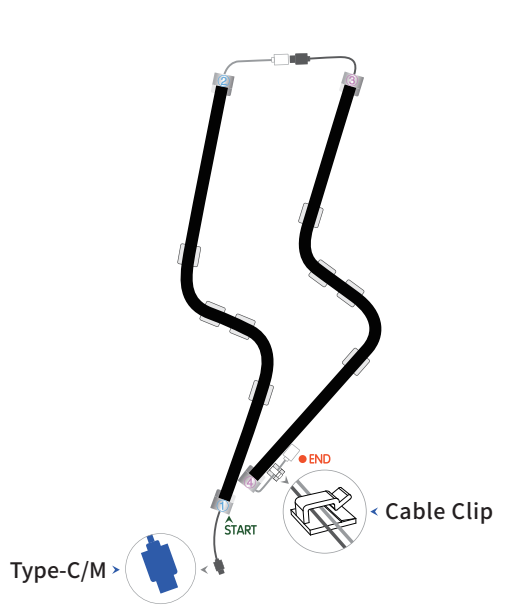

⑦ Use 3in1 charging cable to connect controller, light strip and adapter. Plug into the power adapter and connect to a power source.

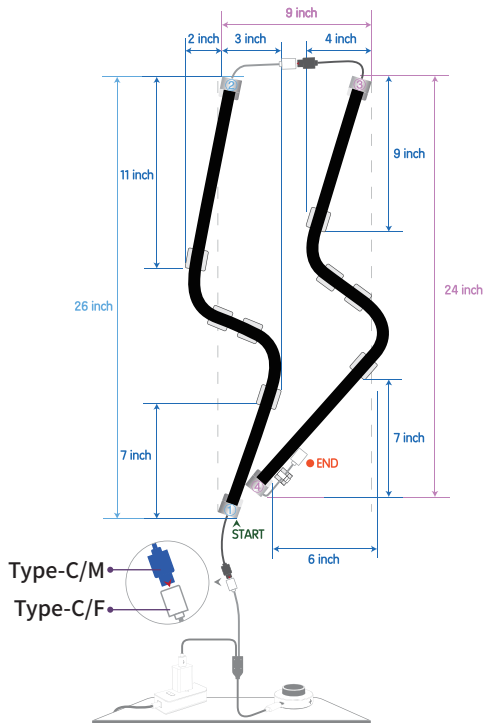

Scan QR Code to Get
DIY Guide for More Shapes



Controller Operation

1. Turn on/off lighting

① After plug into power, press control knob to turn on lighting;

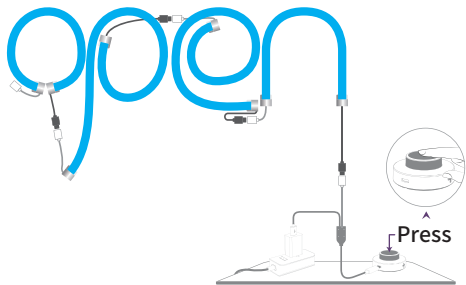

② Long press control knob for 3 seconds to turn off lighting.



2. Lighting Selection

After turn on light

① Press "**Control Knob**" to switch lighting mode, as followed Rainbow, Fire, Holiday, Firework, Spectrum, Chase, Breathe, Music, Random;

② Double press "**Control Knob**" to switch sub-mode.

Attention: Each time the light strip being turned on/off, the currently-selected lighting.

3. Speed Adjustment

① Turn controller knob in clockwise direction to speed up lighting;

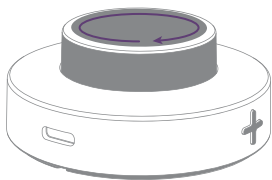

② Turn controller knob in a counter-clockwise direction to slow down lightning.

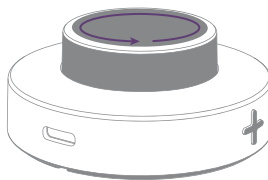

4. Brightness Adjustment

① Press "+" increase brightness;

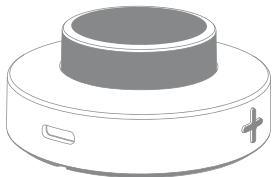

② Press "-" decrease brightness.

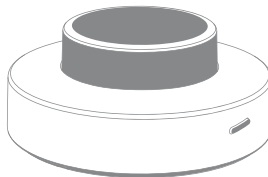

WiFi Connecting

1. Download the app

Download "**Dekala**" app from App Store/Google Play or Scan the QR code, sign up and log in.



Works with the
Amazon Alexa



Works with the
Google Assistant

Attention: Turn on GPS location, WiFi (2.4 GHz only) and Bluetooth before connecting the bars to your WiFi (2.4 GHz only), then you can choose auto-search connect or manually connect.

2. Operating on the bars

After plugging in to power, long press control knob for 5 seconds, light strip will flash in blue. It means light strip is ready to connect to WiFi.

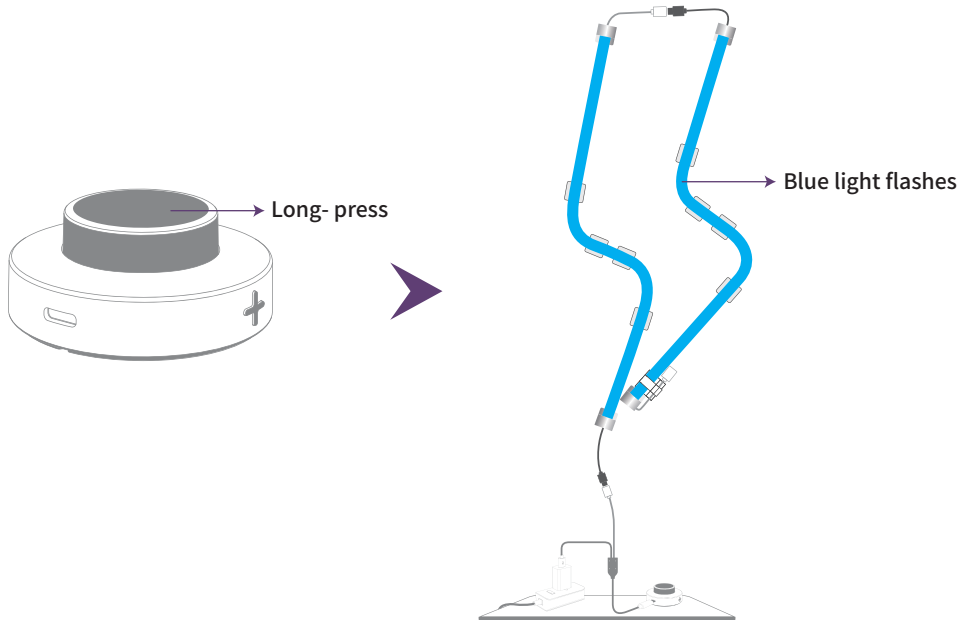

Attention: LightFlow™ Only Supports 2.4G WiFi.

APP Guidance

1. Connect device to app

① Open up "Dekala" app, click on "+ " or "Add Device";

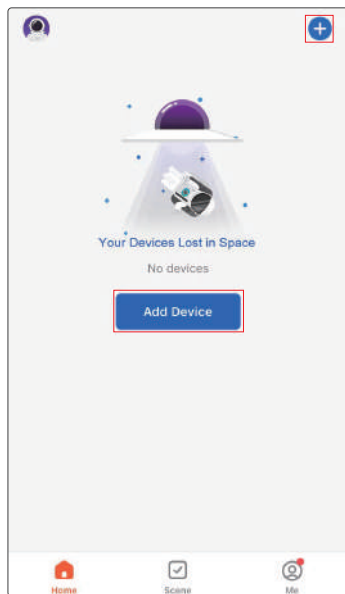

② App will search devices automatically through Bluetooth, then tap "Add";

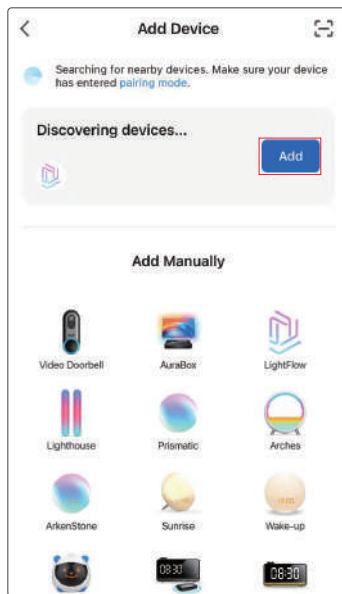

③ Tap "+ ";

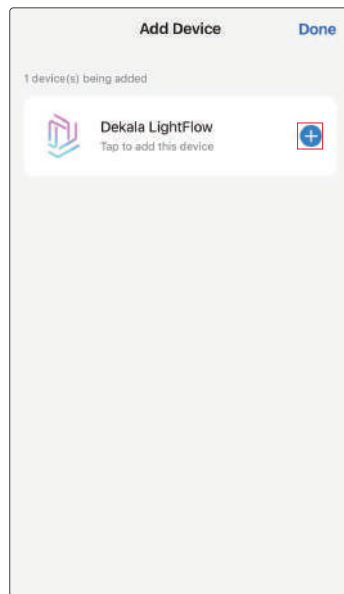

④ Choose 2.4G WiFi network and input password (Only 2.4G WiFi);

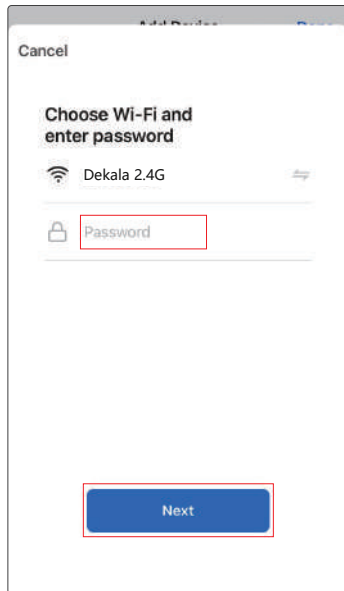

⑤ Wait for device access- ing to WiFi;

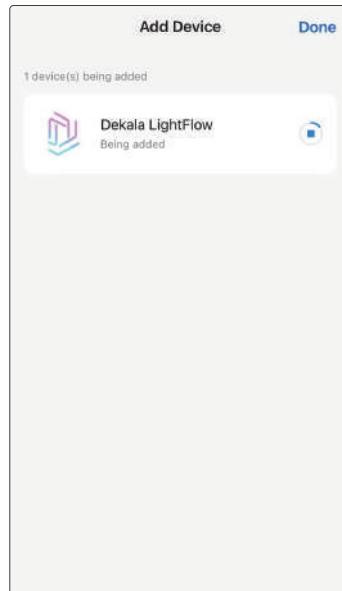

⑥ Tap "Done".



2. Home Page

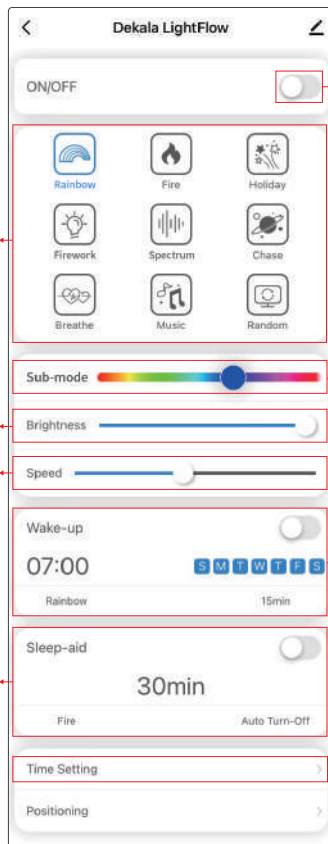

Light switch

Lighting effects
(Rainbow, Fire, Holiday, Firework, Spectrum,
Chase, Breathe, Music, Random.)

Sub-mode selecting
(Within the current lighting effect)

Brightness control

Speed control



Wake-up light setting

After choosing Music mode as wake-up light,
If there is no any sound during wake-up
alarm time, the light will not turn on.

Sleep-aid

Time format setting

3. Light switch and re-name

- ① Click "  " to turn on/off the light;
- ② For voice control purposes, you can click the "  " to re-name the device.

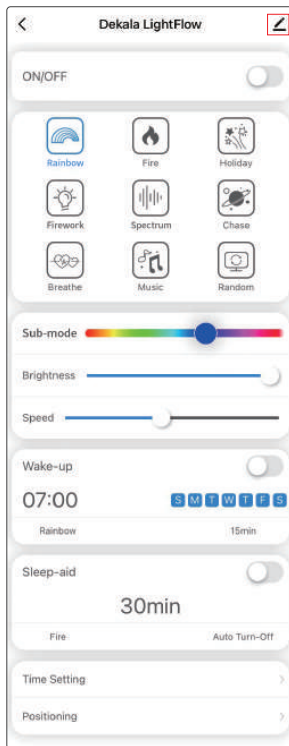
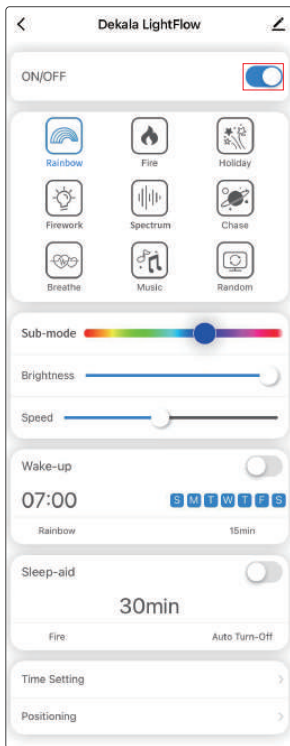



4. Lighting effects setting

① Swipe "  " to choose sub-mode of lighting effect;

Quantity of sub-modes in each lighting effect

Rainbow	Fire	Holiday	Firework	Spectrum	Chase	Breathe	Music
4	4	4	9	9	7	9	5



② Swipe "  " to adjust the brightness;

③ Swipe "  " to adjust the speed.

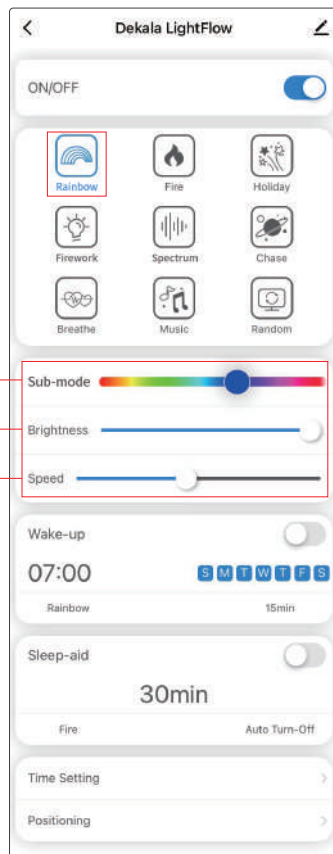
* Speed adjusting doesn't work under "Color".



5. Wake-up light setting

- ① Click "  " to turn on/off wake-up light;
- ② Tap on "Wake-up" section for more detailed setting, click " < " to save and exit;
- ③ The "Wake-up" light automatically turns off when it reaches the set time; When the "Wake-up" light is on, click "  " to turn off the light; Click "  " to deactivate "Wake-up" light.

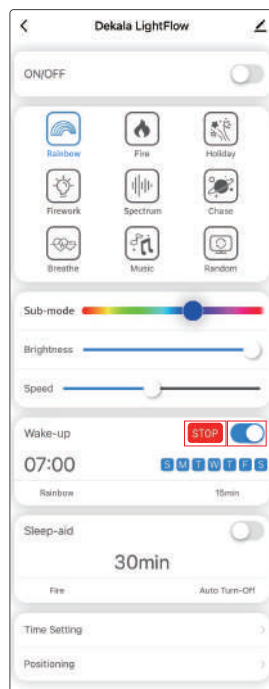
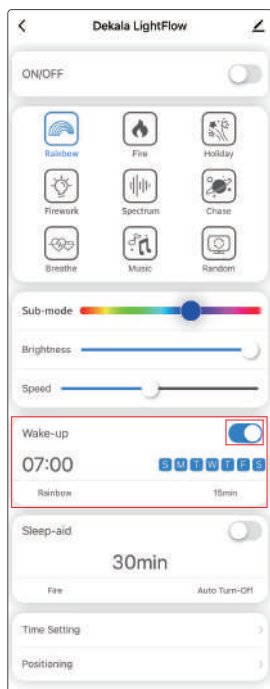

6. Sleep-aid setting

- ① Click "  " in the sleep-aid section to turn on/off sleep-aid light;
- ② Tap on "Sleep-aid" section for more detailed setting, click " < " to save and exit.

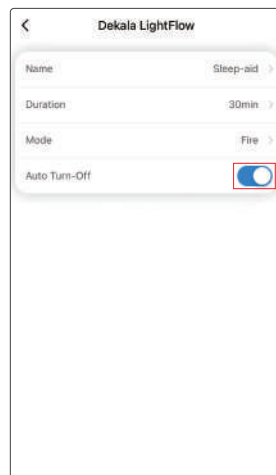
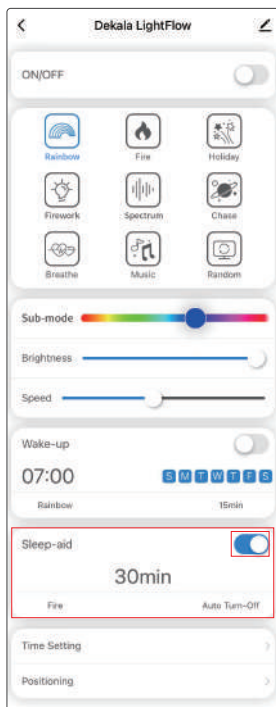

7. Time format setting

Click "Time Setting", switch on/off 24-hour system and network time synchronization (with WiFi only).

*Network time synchronization is suggested to leave on at all time.

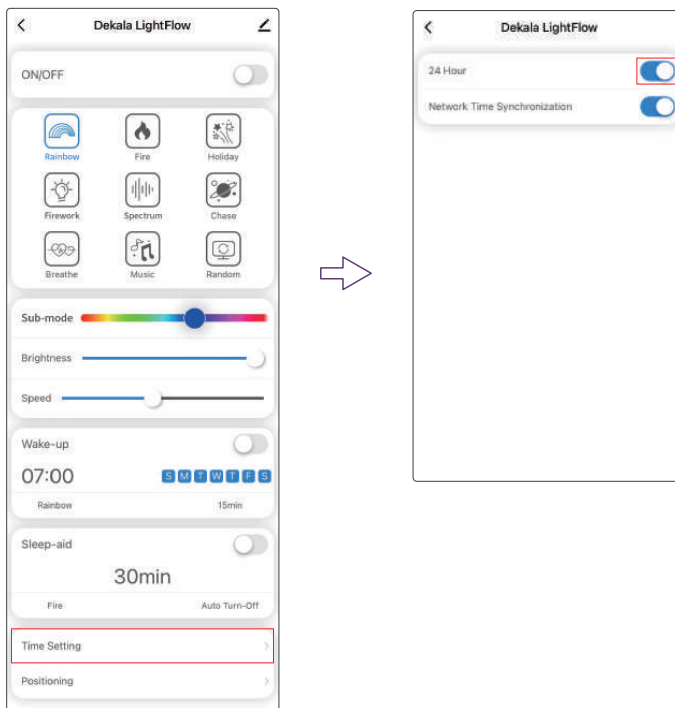

8. Other setting

Click "✎" in the upper right corner to enter, on this screen you can view device information. Third party control guidelines, offline notification, remove the device and so on.

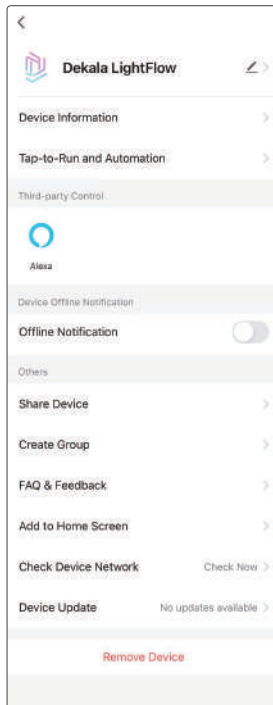
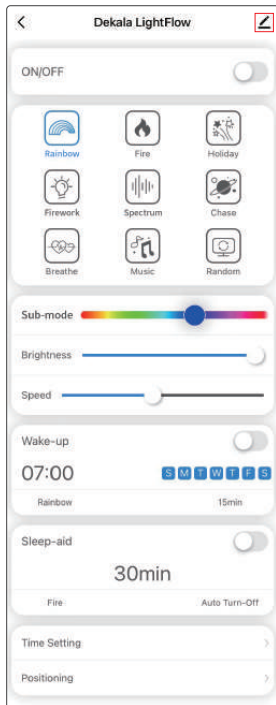

Voice Control

Take "Alexa" connecting setup as an example.

Attention: Make sure device has already linked with the Dekala App.

- ① Download **"Amazon Alexa"** from Google Play/App Store and sign up (If you are already an Alexa user, you can just open it).
- ② Choose **"Skills & Games"**, search Dekala and tap **"ENABLE TO USE"**.

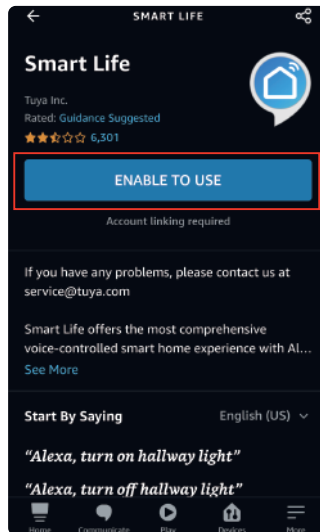
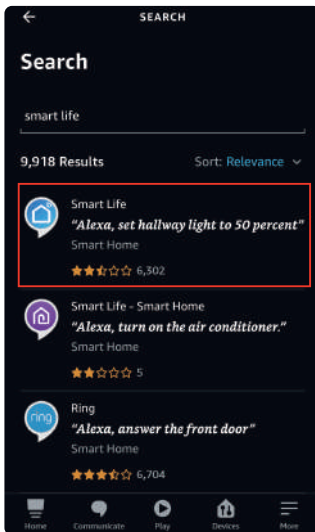
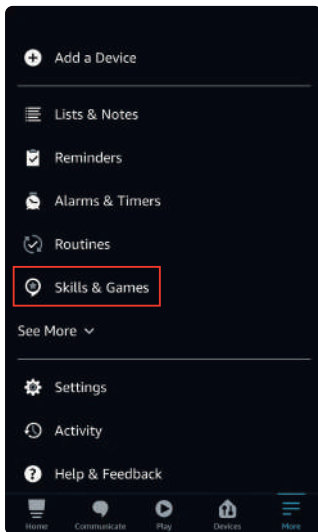

③ Tap on "Launch" and log in to Alexa Dekala with the same username and password you have for Dekala app and tap "Agree and link". You are able to voice control the device with Amazon Echo (Alexa) after seeing "Your Dekala account has been successfully linked."

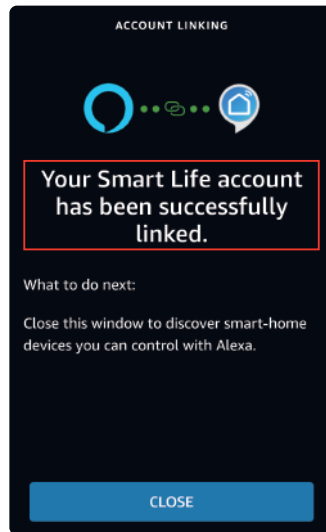
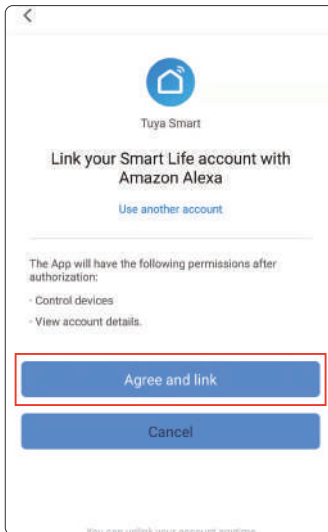
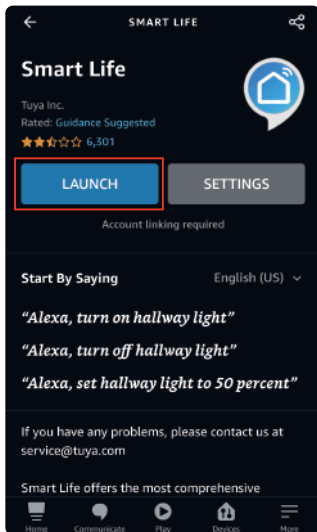

④ Open Dekala app to check if the third-party control has linked, if it shows yes, it means the two accounts has linked up on cloud. You can rename the device with Dekala app and Alexa will automatically synchronize the new name via cloud.

Attention: You can also have Alexa discover new devices and repeat the linking process to re-link with the re-named device via Dekala app. (only an optional operation)

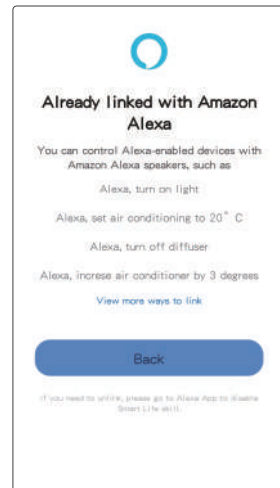
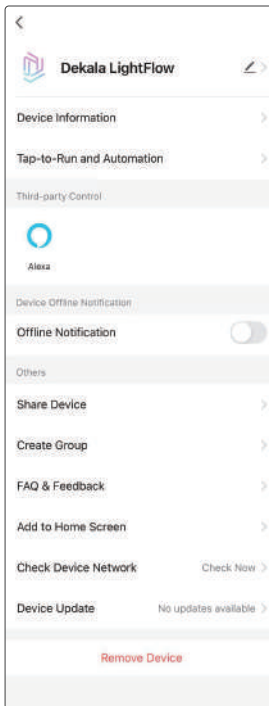
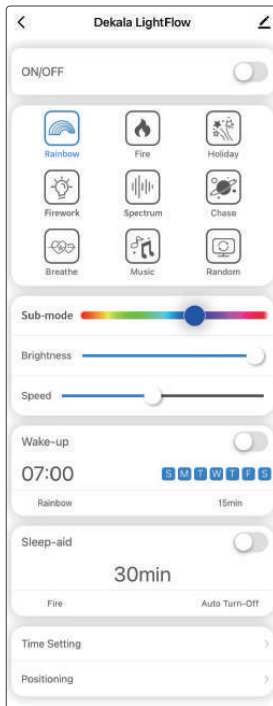

Voice control demonstration

You can re-name all the functions of device, Alexa will sync with the new names and recognize them as voice commands.

Works with Alexa/Google smart home.

Attention: Minor delay might occur due to various Wi-Fi speed and cloud processing system, when device or Alexa fail to react to voice control, please wait for a few minutes and try again.

Here are some things to try

“Alexa, Turn on/off the light flow”

“Alexa, Set the light flow to Rainbow/Flame/Holiday/Fireworks/Spectrum/Chase/Breath /Music/Random”

“Alexa, Set the light flow to 50%”

“Alexa, Change light flow to Red/Orange/Yellow/Green/Blue”

“Alexa, Turn on/of the Wake-up”

“Alexa, Turn on/off the Sleep-aid”

FAQ

1. The device cannot be connected to WiFi?

- ① Please put the router, device and mobile phone in the same area (as closely as possible);
- ② Please make sure your WiFi signal is strong or usable at least; (only 2.4 GHz WiFi network is supported)
- ③ To connect to a different smartphone or WiFi network, please long-press  to re-enter WiFi connecting mode;
- ④ Please make app access to Bluetooth and turn on Bluetooth of cellphone.

2. App suddenly loses control over the device?

It could be the network or the device is offline.

- ① Please make sure that the device is powered on;
- ② Check the strength of the WiFi signal (open a random web page on your phone as testing) and whether the device and your smartphone are connected under the same WiFi (2.4 GHz only);
- ③ Open Dekala app and stay on the home page for 3 minutes and see if the device is still online (connected);
- ④ Re-open Dekala app and try again.

3. How to reset WiFi connection on the device?

When the light is off, long-press the  until the blue light flashes to reset the WiFi connection.

4. Changes in setting on App don't sync with the device?

- ① Check WiFi connection (2.4 GHz only);
- ② Re-open Dekala app and try again;
- ③ check the internet (WIFI) speed is slow or not.

5. Smartphone loses control over the device when under separated locations (different WiFi)?

- ① Check WiFi connection (2.4 GHz only)
- ② Re-start the router and try connecting the device and your smartphone via Dekala app again. (under the same WiFi, 2.4 GHz only)