



## **Dekala Arches™ (Elite) Smart Ambient Lamp**

---

(SAC-WWBLR)

### **Instructions**

Please read the instructions carefully before use and keep it with proper storage  
(v2.0)

-Scan QR Code to Download User Manual-



## Content

General Description .....	02
Display Icons .....	02
Product Overview .....	03
Buttons .....	03
App Control .....	04
Voice Control .....	10
Button Control .....	12
Specification .....	14
FAQ .....	15
Cautions .....	16
Notes .....	16

## General Description

- This is a smart furnishing piece that combines the functionalities of a sunrise alarm clock, a LED ambient light, a Hi-Fi bluetooth speaker, a wireless charging station, a night light table lamp and a sleep-aid white noise machine.
- Aesthetically designed to a chic look that helps boosting you up at day and calming you down at night.
- 3.5-inch display screen, freely dimmable to darkness for those who are light-sensitive at night.
- Comes with two independent sets of alarm clock (8 great-nature simulating alarm sounds optional) .
- The relaxing night light and sleep-aiding white noises (8 sounds optional) simulates the fireplace, brings you harmony before turning in, both sound and light turn off automatically when reach the preset duration (up to 90 minutes) .
- Automatically synchronize and display local time and weather status when connecting to Wi-Fi.
- Time-Display system switched between decimal hour system (12-hour clock) and military time (24-hour clock) .
- Hi-Fi bluetooth speaker and immersive ambient light provide a party vibe with a trending RGB lighting-effect. Now your friends and family can enjoy yourselves at anytime.
- All functions are remote controllable by app, makes a great companion in the kid's room.
- Works with Amazon Alexa and Google Home Assistant, you can control the light freely by voice commands, totally hands free.

## Display Icons

### Weather Status

Real-time Local weather status shown when connected Wi-Fi.

Status: clear, cloudy, rain, snow, thunderstorm, cloud.



### Time Display

Real-time Local shown when connected to Wi-Fi; DST (summer time) auto-adjusting supported.

Switchable between 24H and 12H (am/pm) display.

AM  
08:30

### Alarm Clock 1/2

Dual alarm clocks available  
Alarm clock icons shown: activated;  
Alarm clock icons hidden: deactivated.



### Wi-Fi

Wi-Fi icon flashes: connecting;  
Wi-Fi icon stays solid: connected;  
Wi-Fi icon hidden: fail to connect. (Long press WiFi button to reset.)



### Bluetooth

Bluetooth icon flashes: pairing;  
Bluetooth icon stays solid: connected;  
Bluetooth icon hidden: bluetooth off.



### Wireless Charger

Wireless charger icon stays solid: charging;  
Wireless charger icon flashes: FOD ("Foreign body detection", please remove the non-wireless charging objects).



## Product Overview



Overview

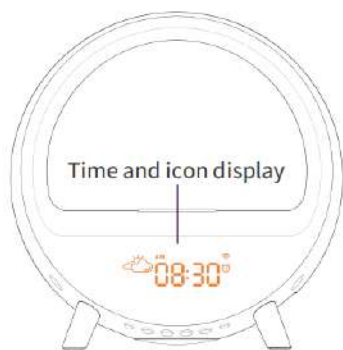

Front view

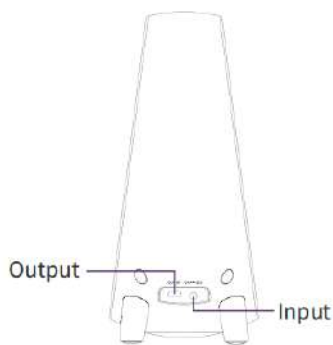

Right-side view

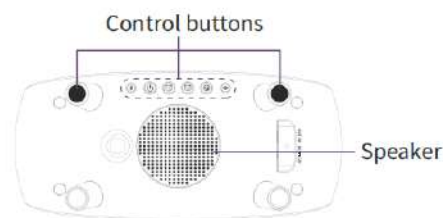

Bottom view

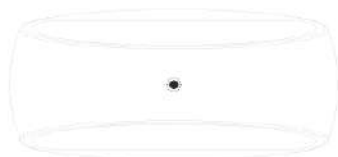

Top view

## Buttons

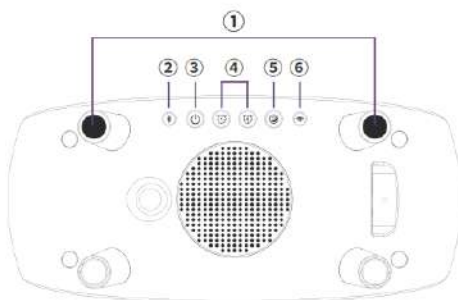

- |   |                 |   |
|---|-----------------|---|
| ① |                 | Snooze/Ambilight (Ambient light) switch |
| ② | Bluetooth icon  | Bluetooth                               |
| ③ | Power icon      | Light ON/OFF and brightness adjustment  |
| ④ | Alarm 1/2 icons | Alarm1/2                                |
| ⑤ | Sleep Mode icon | Sleep Mode                              |
| ⑥ | Wi-Fi icon      | Wi-Fi Connection                        |

Press down to switch among different ambient lighting (Ambilight) or turn on snooze mode.

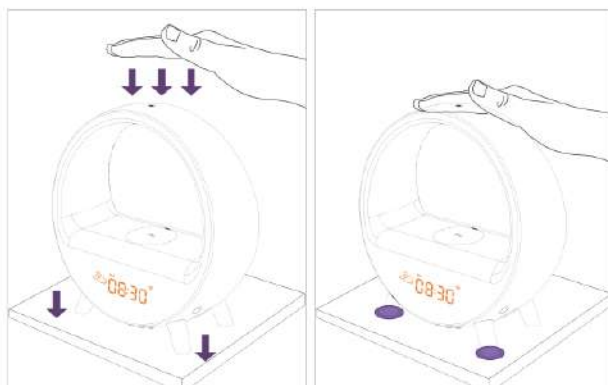

## App Control

### Wi-Fi connecting

#### 1. Download the app

Download "Smart Life" from App Store / Google Play or Scan the QR code, sign up and log in.



#### 2. Operating on cellphone

Turn on GPS location.



Turn on Bluetooth.

Connect your mobile device to a 2.4 GHz WiFi network during setup. (This is commonly indicated by a 2, 2.4, or 2G at the end of the network name.)

#### 3. Operating on device

Connect the device to the power source then long press to make the  flash.

 is flashing: Means the device is ready to connect to Wi-Fi (2.4 GHz only).

 is solid on: Please long press the  button more than 3 seconds to reset WiFi.

 is hidden: Means fail to enter into Internet. Then reset WiFi and make sure network is 2.4G WiFi (Not 5G), next input right WiFi name and password.

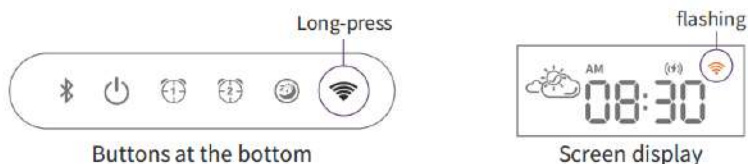

Buttons at the bottom

Screen display

## Connect device to app

### App auto-search and connect

① Open up "Smart Life" app, click "+" ;



② Click on "Go to add" ;

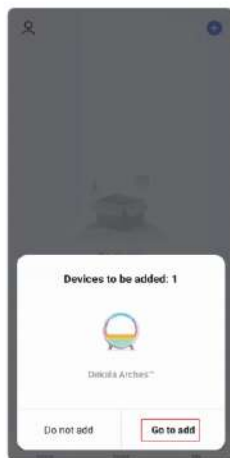

③ Click "+" after "Dekala Arches" shows up ;

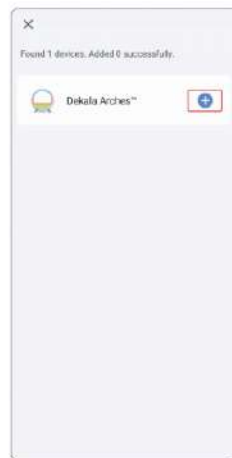

④ Type in the 2.4 GHz WiFi password and click on "Next" (make sure the smartphone and Smart Life app are both connected to 2.4 GHz Wi-Fi) ;



⑤ Put device, smartphone and the router in the same area when connecting (preferably in short distance) ;

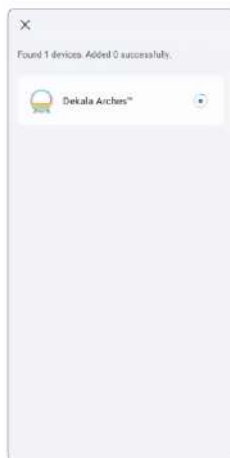

⑥ You can re-name the device after connected to 2.4 GHz Wi-Fi, click on "Done" to complete the Wi-Fi connecting process (The signal icon stays solid on the screen of the device) .



**Attention:** Once the initial connection is made between the device and your smartphone via 2.4 GHz Wi-Fi. The remote control access between the device and your smartphone will no longer require the initial 2.4 GHz Wi-Fi. Therefore, you can control the Dekala device with Smart Life app using cellular data, 5G Wi-Fi or any other networks later on .

## App home page

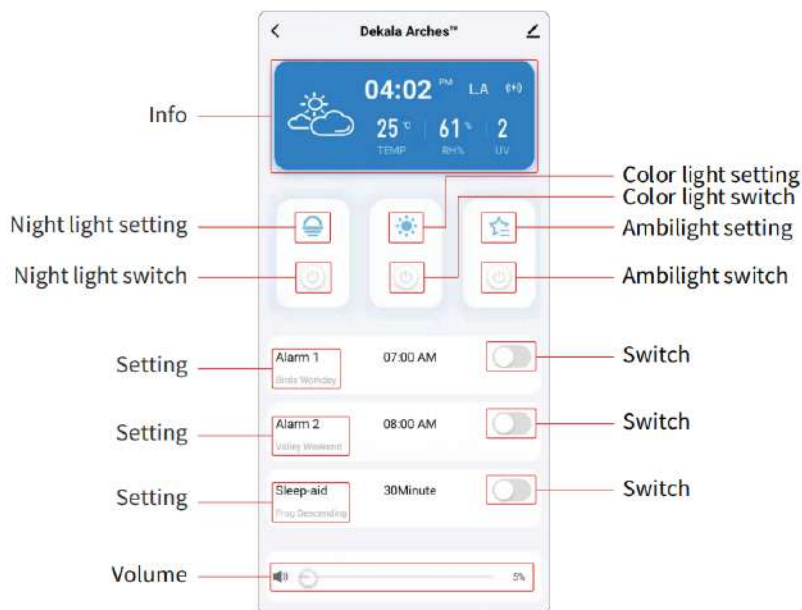

## Screen display setting

- ① Automatic time calibration once connected to Wi-Fi (12-hour clock by default) ;
- ② Click the "info" section to enter detailed settings;
- ③ Click "save" at the top right to apply and exit.

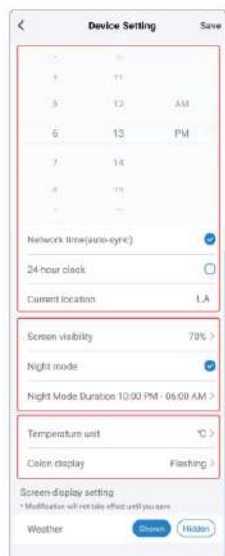

1. Deactivate "Network time" to manually calibrate the time;
2. 24-hour clock system available;
3. Auto-detected cellphone location, no manual setting required.

1. 5 levels of screen visibility available;
2. activate "Night mode" to set the screen visibility under "Night mode"; deactivate "Night mode" to set the screen visibility in general;
3. set the "Night mode" duration.

1. Temperature display: both Fahrenheit and Celsius available;
2. Choose whether the colon between "hour" and "minute" flashes or stays solid.

## Alarms setting

Dual alarm clocks available

"Alarm 1" is recommended to be used as a workday alarm, "Alarm 2" can be used as a weekend alarm or an event notification. Both alarms are set the same way;

The "🔔" "🔔" stays on when the alarms are activated.



① You can turn both "Alarm 1" and "Alarm 2" on/off directly on Smart Life app home page;

② Click "Alarm 1" or "Alarm 2" section to enter the detailed settings;

③ Click "save" at the top right to apply and exit.

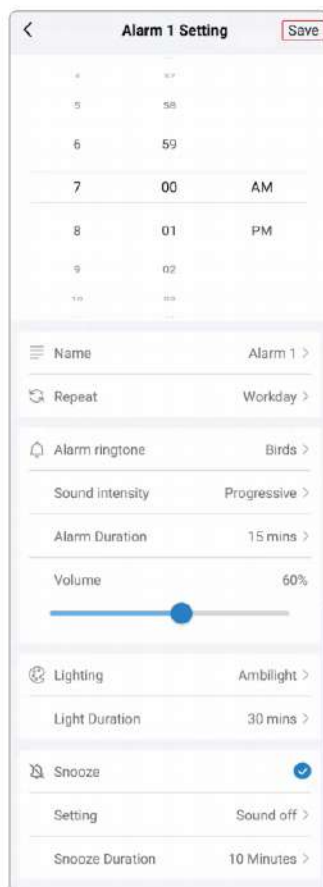
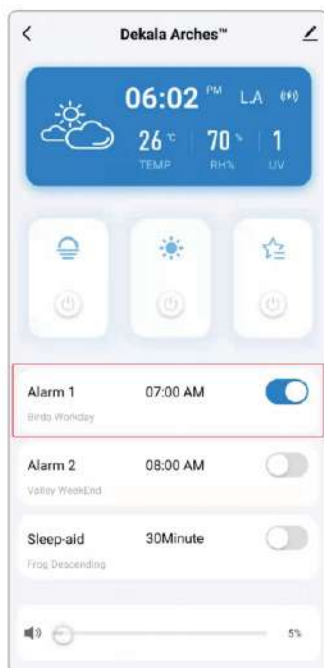



## Night light

- 1 Click "🌙" below "☁️" to turn on/off "Night light";
- 2 Click "🌙" to enter "Night light" setting page; You can re-edit the name (for voice command purposes) and adjust the brightness.

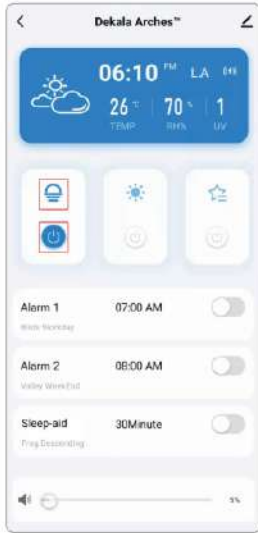

## Color light

- 1 Click "🌙" below "☀️" to turn on/off "Color light";
- 2 Click "☀️" to enter "Color light" setting page; You can re-edit the name (for voice command purposes), customize the color and adjust the brightness.



## Ambilight (Ambient light)

- 1 Click "🌈" below "🌟" to turn on/off "Ambilight";
- 2 Click "🌈" to enter "Ambilight light" setting page; You can re-edit the name (for voice command purposes), select the lighting effect and adjust the brightness;
- 3 Click "edit" to set the color or the speed of the lighting flow (certain lighting effects only);
- 4 Click "save" at the top right to apply and exit.



**Romantic Breathe:** Click "Romantic Breathe" to turn on breathe training. Adjust your breathing accordingly to the lights; when the red light is on, breathe in; when the red light fades, breathe out. Click "Edit" to set the speed (breathing rate).

## Sleep-aid

- 1 You can turn "Sleep-aid" on/off directly on Smart Life app home page;
- 2 Click "Sleep-aid" section to enter the detailed settings;
- 3 Click "save" at the top right to apply and exit.

**Note:** Cancel "Auto turn-off", sleep sounds play all the time.

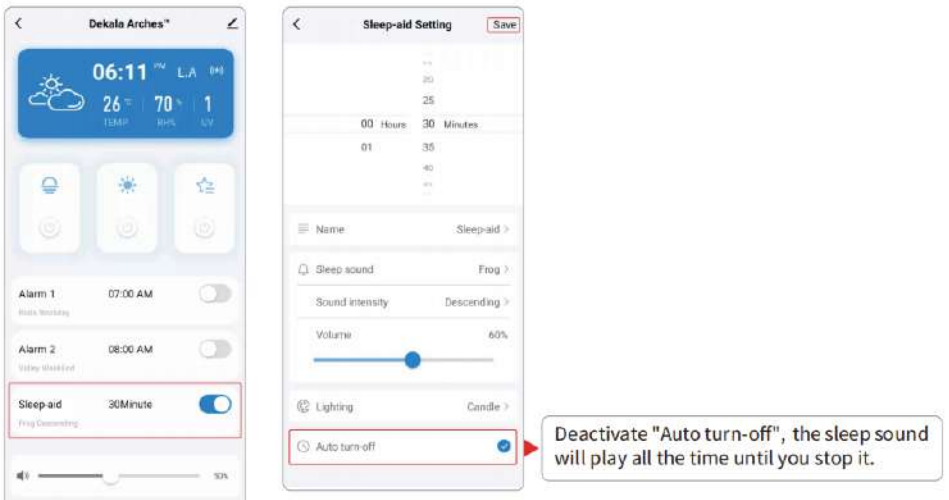

# Voice Control

## Take "Alexa" connecting setup as an example

**Attention:** Make sure device has already linked with the Smart Life app

- ① Download **"Amazon Alexa"** from Google Play / App Store and sign up (If you are already an Alexa user, you can just open it);
- ② Choose **"Skills & Games"**, search Smart Life and Click **"ENABLE TO USE"**.

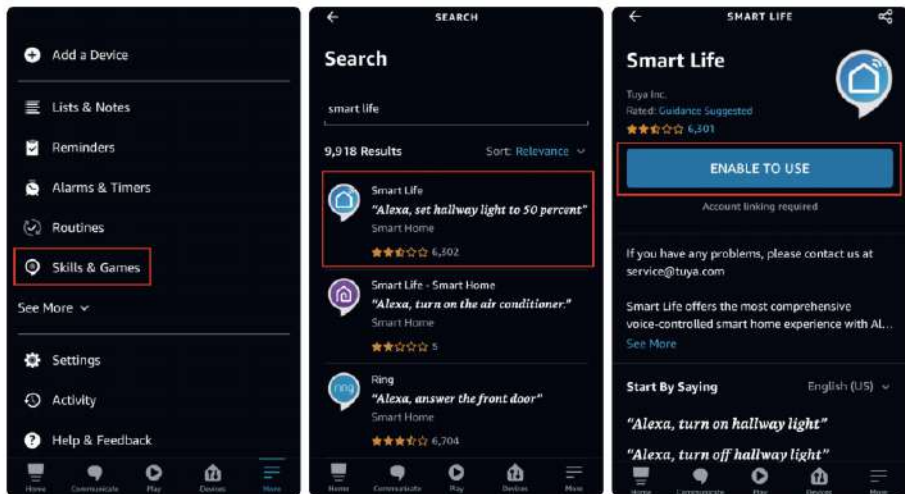

③ **"Launch"** and log in to Alexa Smart Life with the same username and password you have for Smart Life app and Click **"Agree and link"**. You are able to voice control the device with Amazon Echo (Alexa) after seeing **"Your Smart Life account has been successfully linked"**;

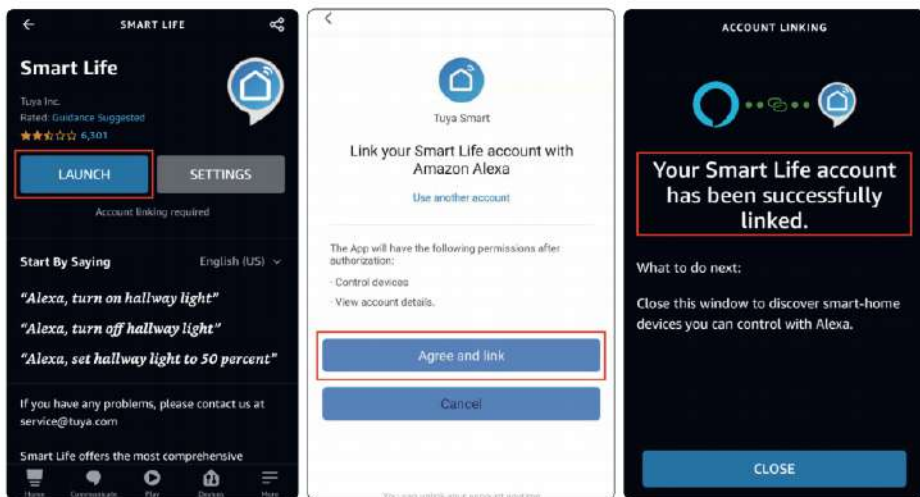

④ Open Smart Life app to check if the third-party control has linked, if it shows yes, it means the two accounts has linked up on cloud. You can re-name the device with Smart Life app and Alexa will automatically synchronize the new name via cloud.

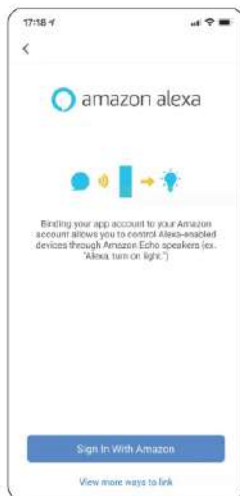
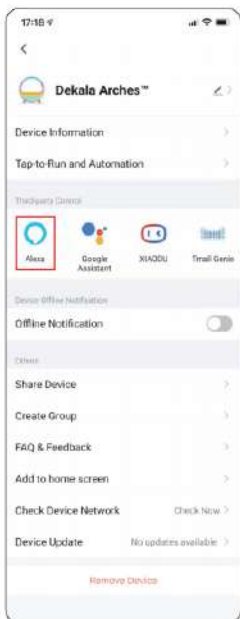

**Attention:** You can also have Alexa discover new devices and repeat the linking process to re-link with the re-named device via Smart Life app (only an optional operation) .

## Voice control

You can re-name all the functions of device, Alexa will sync with the new names and recognize them as voice commands.

Works with Alexa / Google smart home.

**Attention:** Minor delay might occur due to various Wi-Fi speed and cloud processing system, when device or Alexa fail to react to voice control, please wait a few minutes and try again.

## Here are some commands to try

"Alexa, Turn on/off the Night Light"

"Alexa, Set Night Light to 20%"

"Alexa, Turn on/off the Color Light"

"Alexa, Change Color Light to red"

"Alexa, Turn on/off the Alarm 1/Alarm 2"

"Alexa, Turn on/off the Sleep-aid"

## Button control

### Bluetooth

Press "🔌" to turn on/off the bluetooth speaker.

#### Bluetooth pairing

- Press "🔌" at the bottom of the device to turn on bluetooth, the bluetooth icon "🔌" shows up on the screen and flashes quickly with a notification sound, indicating the device is ready to pair with a smartphone.
- Turn on the bluetooth on your smartphone and select "Dekala Arches™" to start pairing; once a notification sound coming from the device with the flashing "🔌" on the screen turns solid, the bluetooth connection is successfully completed; Now the music is ready to be played.
- To pair the bluetooth speaker with another smartphone, simply turn off the bluetooth on smartphone that's currently connected with the device and try connecting it from another smartphone.



Bluetooth button



Screen display

- "🔌" is flashing: Pairing;
- "🔌" stays solid: Connected;
- "🔌" is hidden: Bluetooth off.

### Alarms (Go to Smart Life app for detailed settings)

1. press "🕒" "🕒" to activate/deactivate the device;
2. Each time the alarm is activated, the preset alarm schedule shows on the screen for 3 seconds;
3. Attention: The alarm gets automatically turned off after 30 minutes of beeping without any operation on the device.

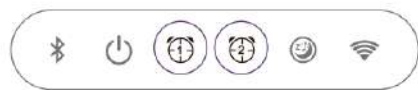

Alarm buttons ("Alarm 1" "Alarm 2")



Screen display

- "🕒/🕒" stays solid: Activated;
- "🔌" is hidden: Deactivated.

### Snooze mode (Go to Smart Life app for detailed settings)

Enter snooze mode (up to 5 times per scheduled alarm)

There are 2 ways to enter snooze mode:

1. During the alarm beeping, press down the device to enter snooze mode;
2. Click "snooze" on Smart Life app home page to enter snooze mode.

Turn off the alarm (won't beep again until the next preset alarm-time)

There are 2 ways to turn off the alarm:

1. Press any button at the bottom of the device to turn off the alarm;
2. Click "stop" on Smart Life app home page to turn off the alarm.

Press down the device (as the picture shown) to enter snooze mode.

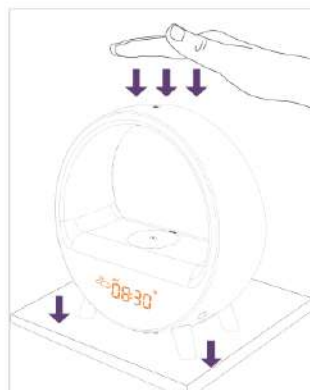

## Night light (Go to Smart Life app for detailed settings)

- ① When the light is off, press down the device to turn on "Night light";
- ② Long-press "⏻" at the bottom of the device to adjust the brightness;
- ③ Press "⏻" at the bottom of the device to turn off the "Night light".

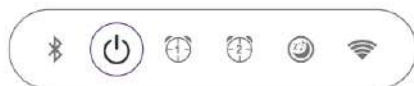

Switch button

## Ambilight (Ambient light) (Go to Smart Life app for detailed settings)

- ① When the light is on, press down the device to switch "Ambilight" lighting effects;
- ② Long-press "⏻" at the bottom of the device to adjust the brightness;
- ③ Press "⏻" at the bottom of the device to turn off the "Ambilight".

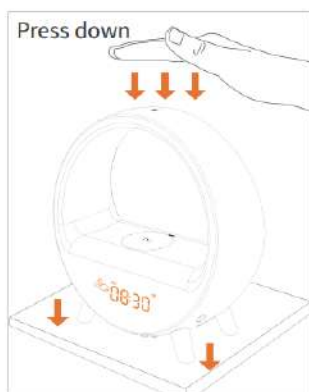

Switch button

## Sleep-aid (Go to Smart Life app for detailed settings)

- ① Press "😊" to turn on/off "Sleep-aid".
- ② Press "⏻" to turn off the light during "Sleep-aid".



"Sleep-aid" light switch / "Sleep-aid" button

## Wireless charger

- ① Place your wireless-charging supported smartphone on the **Charging Pad** to start charging your smartphone;
- ② "🔋" on the screen is on and stays solid means your smartphone is being charged;
- ③ "🔋" on the screen is hidden means your smartphone isn't being charged;

④ FOD (Foreign body detection) : " (F) " on the screen is flashing means your smartphone isn't wireless-charging supported; therefore, it's not being charged.



Screen display

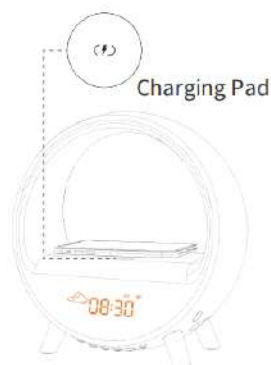

## Charging output

Type-C power cable supported.

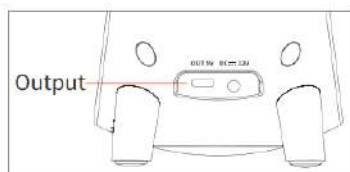

Right-side view

## Specification

Name	Dekala Arches™
Model	SAC-WWBLR
Size	226×231×103.6mm
Weight	700g
Color	White
Material	ABS, PC, Metal
Communication mode	Wi-Fi (2.4G) + BLE Module
Control mode	Button control, App control, voice control (connect to third-party smart speaker)
Input	Adapter 24W (12V-2A), DC input
Output	Output - Wireless Charger (5V-1A)
Power	24W (MAX)
Speaker	4Ω 5W
Working environment	Temperature:0°C-45°C Humidity:0% ~80% RH
Storage environment	Temperature:-20°C-65°C Humidity:0% ~90% RH
Packing list	Dekala Arches™×1、 User Guide×1、 Adapter×1
Certification	

**1. Fail to find the device.**

- ① Please turn on cellphone's Bluetooth. Then put device and cellphone as close as possible;
- ② Please check the device is powered on.

**2. Fail to connect WiFi ( the"  " is hidden.).**

- ① Please check your phone connect to a 2.4 GHz WiFi network during setup, not 5GHz WiFi;
- ② Make sure your phone and device under the same WiFi;
- ③ Make sure the WiFi name and password is correct;
- ④ If you input the wrong WiFi or wrong passwords, please long press the "  " button to reset WiFi and choose the right WiFi and passwords.

**3. How to find your 2.4 GHz WiFi network name and password.**

- ① Look on your WiFi router label. Many routers have a label that shows the WiFi network name, which is also called an SSID. Your 2.4 GHz network name might have a 2, 2.4, or 2G at the end. Your 5 GHz network name might have a 5 or 5G at the end.
- ② If your WiFi network name or SSID doesn't indicate whether it's 2.4 GHz or 5 GHz, ask your Internet service provider (ISP) or the person who set up your WiFi router.
- ③ If you have a mesh WiFi network, it uses only one WiFi network name for both WiFi bands. The device finds and connects to the 2.4 GHz WiFi band. As long as you connect your phone to the same mesh network, App can discover the device.

**4. Bluetooth connection failed.**

- ① Please confirm whether the mobile phone Bluetooth is enabled;
- ② Please confirm whether the device has been connected to another Bluetooth device.

**5. App loses control over the device.**

- ① Please make sure that the device is powered on;
- ② Check the strength of the Wi-Fi signal (open a random web page as testing) and whether the device and your smartphone are connected under the same Wi-Fi (2.4 GHz only) ;
- ③ Re-open Smart Life app and try again.

**6. Changes in setting on app don't sync with the device.**

- ① Check the Wi-Fi connection between the device and your smartphone and the strength of Wi-Fi signal (open a random web page as testing) ;
- ② Re-open Smart Life app and try again.

**7. Smartphone loses control over the device when under separated locations (different Wi-Fi).**

Check the strength of Wi-Fi signal (open a random web page as testing) , and make sure the device and your smartphone are connected under the same Wi-Fi (2.4 GHz only) .

- ① Re-open Smart Life app and try again;
- ② Try re-starting the router.

**8. Other issues.**

If issues still occur under the instructions above, please go to the Dekala Arches™ home page on Smart Life app and click at the top right and select "FAQ & Feedback", then click "Unresolved? Send Feedback" to submit your issue, and feel free to contact us by E-mail at [info@dekalastore.com](mailto:info@dekalastore.com), our troubleshooting team will get back to you ASAP.



## Cautions

- Please use the product correctly according to the instructions. Disassembling and collision are strictly prohibited.
- Please place the product on a stable, horizontal, and non-smooth surface.
- Do not use it in a room with temperature below 0° or above 40°.
- Do not use it in high temperature, humidity and corrosive environment to avoid electric leakage due to circuit damage.
- Please keep it in a proper place and out of reach of children to avoid accidents.
- This product is not fireproof, do not throw it into the fire, and do not place it close to any fire source .
- This product is not waterproof, do not put it into the water to avoid damage.

## Notes

- Please wipe this product with a soft cloth.
- Do not scrub this product with abrasive cleaning agents, rough chemicals, alcohol, acetone cleaning agents, etc., so as not to damage the surface of the product.
- Store the product in a safe, dry place that will not be overstocked, bruised or damaged.
- Do not wrap the power cord around the appliance when storing the product.
- Please use the attached power adapter (5V-2A) to avoid damage to the equipment.
- Please use the product under the instructions. Disassembly and collision on the product are strictly prohibited and will void the warranty.
- Please place the product on stable, flat surface when using.
- Do not use it in high temperature, humid or corrosive environment, so as to avoid leakage caused by circuit damage.
- Although the product is family friendly, to reduce the risk of electric shock, be careful with the children in present when using the product.
- This product is not fireproof, please do not throw it into the fire, do not go near the source of fire.
- This product is not waterproof, please do not put it into the water, so as not to damage the equipment.

**Feel free to contact us if you need further assistance , our troubleshooting team will get back to you ASAP.**

**Official Website : [www.dekalastore.com](http://www.dekalastore.com)**

**Email: [info@dekalastore.com](mailto:info@dekalastore.com)**