

DUMAS

SPINNAKER

AUTOMATIC

This timepiece is equipped with a self-winding Mechanical Automatic movement.

It does not need a battery.

It is powered by the motions of the user's own wrist during the wear of the watch.

You may also choose to wind the watch manually.

For more details on operating this timepiece please refer to the enclosed booklet or visit:

spinnaker-watches.com

DUMAS

SPINNAKER

Instruction Manual

Vol. 1.81-LIW EN

PLEASE READ THE FOLLOWING BEFORE UNSCREWING THE CROWN

Screw-down Crown

Screw-down crowns are used to ensure water resistance. **ALWAYS** be certain that your crown is securely screwed down (Position [0] is secured. Positions [1],[2] and [3] are not secured for water resistance). Do **NOT** unscrew your crown while you are in any environment where moisture is present.

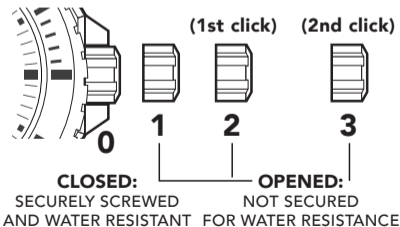
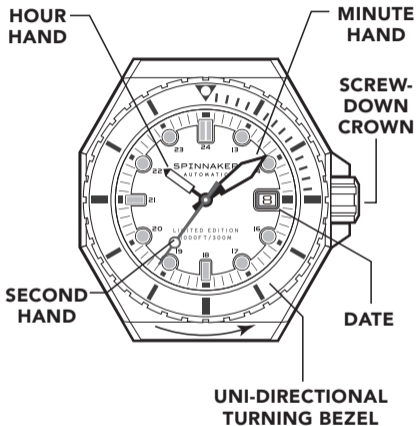

USING THE SCREW-DOWN CROWN

Do **NOT** pull the crown unless it is **UNSCREWED** first:

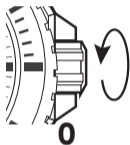

TO UNSCREW: Turn the crown anti-clockwise until it turns freely without tension. **GENTLY** pull the crown out to the other desired positions for watch setting (see specific operating instructions on the following pages).

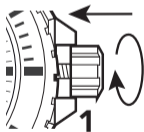

TO SCREW: Push the crown **ALL THE WAY IN** (towards the watch) **THEN** begin to turn clockwise until it is securely screwed down.

NOTE: Failure to **SECURELY** screw down the crown after setting the watch may affect its water resistance.

Before you use this watch, It is recommended that you manually wind the mainspring to start it moving.

THIS WATCH IS AN AUTOMATIC WATCH EQUIPPED WITH A MANUAL WINDING MECHANISM.

WINDING THE MAINSPRING

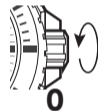

1. Unscrew the crown by turning it anti-clockwise.



2. When it is in position [1], turn the crown clockwise to wind. Wind 15-20 times and it will start to move naturally after shaking slightly.

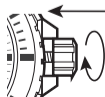

3. Push the crown in then screw it securely.

- * This watch **MUST** be worn for at least 8 (Eight) hours each day to ensure it is fully wound.

An automatic watch will only wind when the watch is on your wrist and your arm moves. Winding the watch by the crown will put power on the spring but not enough to allow the watch to function fully.

If your watch stops overnight or loses time it means it is not being fully wound.

IMPORTANT NOTE

1. If your watch is running smoothly, please do not wind the crown to avoid overwinding the movement. Provided you are wearing the watch frequently, your watch should have sufficient power to operate without any fuss.
2. If your watch has stopped running after a period of not wearing the watch, gently move the watch side to side 20 to 30 times to move the rotor or gently turn the crown 5 to 10 times to get the second hand run at its normal speed.

HOW TO SET THE TIME

1. Unscrew the crown and pull it out to position [3]-(2nd click).
2. Turn the crown clockwise to set the correct time.
3. Push the crown in then screw it securely.

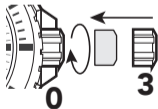
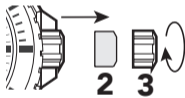
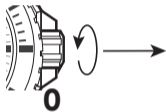

HOW TO SET THE DATE

1. Unscrew the crown and pull it out to position [2].
2. Turn the crown anti-clockwise to set the correct date.
3. Push the crown in then screw it securely.

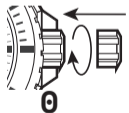
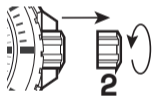
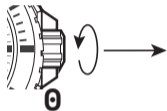

* Do not set the date between 9:00 P.M. and 4:00 A.M.

HOW TO CHANGE THE BRACELET TO RUBBER STRAP

1.

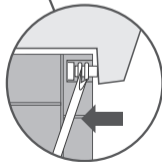
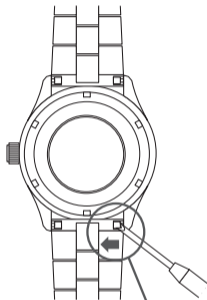

2.

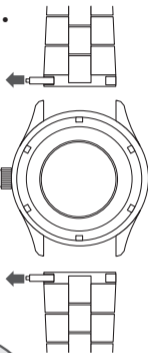

3.

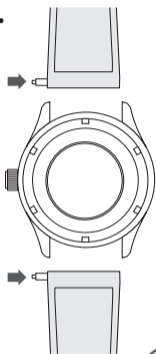

4.

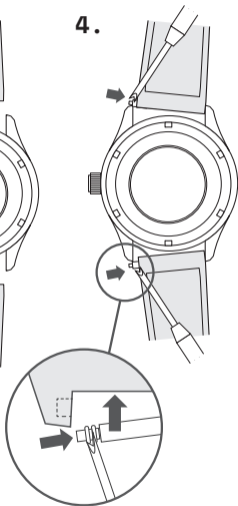

5.

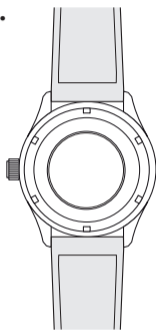

Strap Changing end



HOW TO USE A DEPLOYANT CLASP

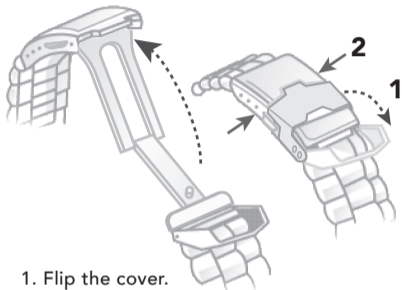

1. Flip the cover.
2. Press the buttons on the clasp sides.

HOW TO RESIZE METAL BRACELET

On the inside of the bracelet, you will see some small arrows engraved on removable links.

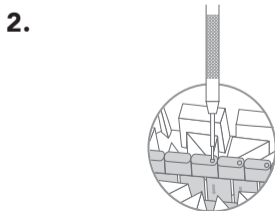
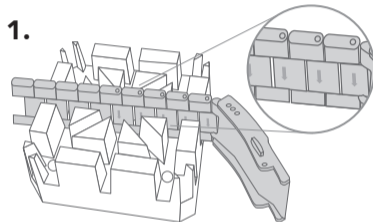

3.

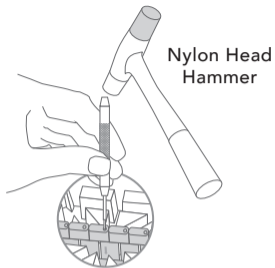

4.

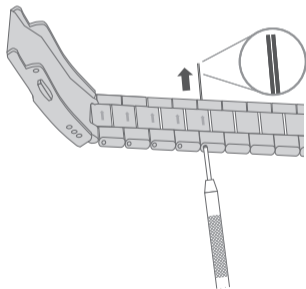

5.

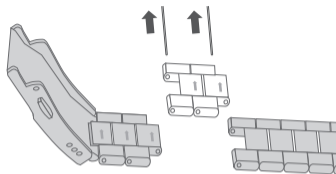

6.

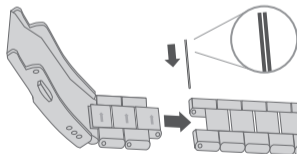

7.

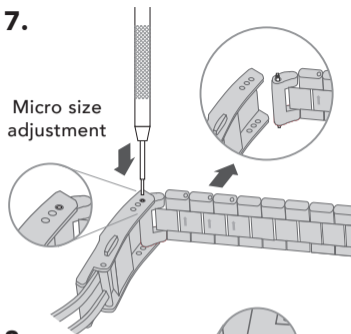

8.

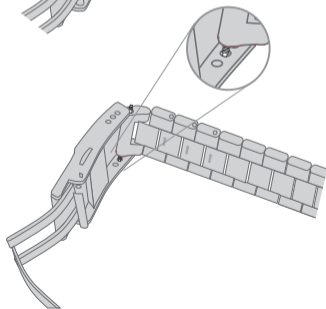

9.

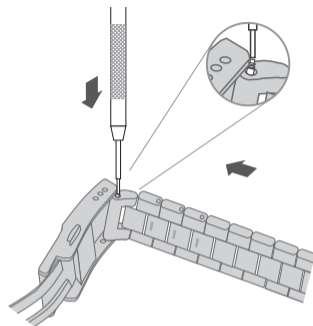

10.

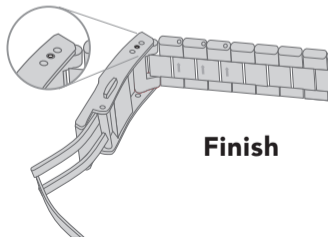

WATER RESISTANCE



Note that the water resistance chart serves only as a guide (please refer to the water resistance chart on the next page). Actual water resistance may vary depending on a number of factors including water temperature, water salinity and use under water.

The water resistance of your timepiece may eventually be compromised over time with general wear and tear and use of your timepiece under adverse conditions.

Always remember to employ the screw down crown if available to maintain the water resistance of your timepiece. Warranty may be voided if the screw down crown has not been properly employed.

Note that you should NEVER wear your watch in a jacuzzi, hot shower or steam room where steam may enter the case despite the watertight seals used to protect your watch.

This may cause condensation inside your watch, which may affect and damage the inner workings of your watch.

WATER RESISTANCE CHART	50M/ 5ATM	100M/ 10ATM	200M/ 20ATM	500M/ 50ATM	1000M/ 100ATM
SPLASH/ SHOWERING					
SWIMMING/ BATHING					
BRIEF SWIMMING/ WATER SPORTS					
PROLONGED SWIMMING/ FREE DIVING					
SCUBA DIVING					
PROFESSIONAL DEEP SEA DIVING					