

ECONOMY SPREADER BEAM - SBM-40-8

APPROX WEIGHT: 192.92 lbs.
DOES NOT INCLUDE WEIGHT OF POWER OR PACKAGING!!!

*** ANY ADDITIONS, DELETIONS, OR OMISSIONS MUST BE CORRECTED ON THIS DRAWING AS THIS DRAWING WILL BE CONSIDERED ALL INCLUSIVE ***

ALL GRAPHICS PROVIDED ARE FOR REFERENCE ONLY. IF CERTAIN DIMENSIONS ARE CRITICAL PLEASE VERIFY THOSE DIMENSIONS WITH YOUR SALESPERSON

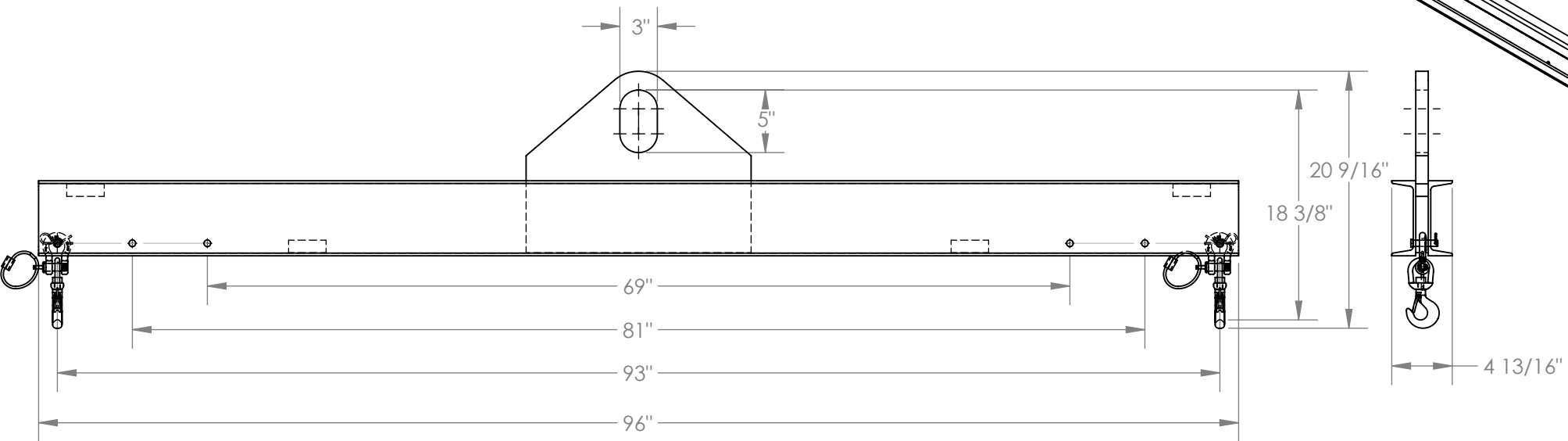
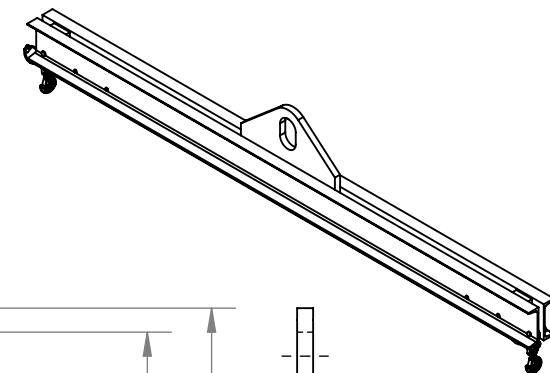

STANDARD FEATURES

- MODEL NUMBER IS SBM-40-8
- OVERALL WIDTH IS 4 13/16"
- OVERALL HEIGHT IS 20 9/16"
- OVERALL LENGTH IS 96"
- USABLE BAIL IS 3"x5"
- MINIMUM SPREAD IS 69"
- MAXIMUM SPREAD IS 93"
- HEADROOM IS 18 3/8"
- MAX CAPACITY IS 4000 LBS.

SPECIAL FEATURES

NONE

DIMENSION TOLERANCE ± 1/4"

APPROVAL	I, THE UNDERSIGNED, AGREE THAT THE PRODUCT AS REPRESENTED SATISFIES DESIGN AND DIMENSION REQUIREMENTS. I ALSO ACKNOWLEDGE MY DUTY TO CONFIRM PRODUCT AND INSTALLATION COMPLIANCE WITH ALL APPLICABLE FEDERAL, STATE AND LOCAL REGULATIONS AND STANDARDS.	
	ANY MODIFIED UNITS ARE NON-RETURNABLE	
	[] As drawn [] As marked	
	Signed: _____	Date: _____
	Printed Name: _____	
LEAD TIME WILL START UPON RECEIPT OF SIGNED APPROVAL DRAWING		

FOR INTERNAL USE ONLY PROJECT SIGN OFF	
SALES	
ENG.	
FAB.	
POWER	

DISTRIBUTOR'S NAME:		P.O.#
VESTIL MANUFACTURING		X
DRAWN BY: DEY		W.O.#
DATE: 12/17/10		X
REFERENCE: X	SCALE: 1:12	SALES: X
QUOTED LEAD TIME: X	QUOTE #	FILE NAME:
	X	08-007-182