

- This manual should be surely handed over to the users.
- The users of the electric chain hoist should thoroughly read this manual.

NO.2

**ELECTRIC CHAIN HOIST
MODELS FA, FB, SA, FAH, FBH
FAⅢ, FBⅢ, SAⅢ, FAHⅢ, FBHⅢ
OPERATION MANUAL**

- Thank you for your purchase of our product.
- It is quite important that you carefully read this operation manual before using the electric chain hoist.
- This manual should be kept close to the electric chain hoist, as the maintenance and inspection works absolutely require it.
- Please consult distributors of our firm's products about the inspection requiring dismantling and assembling of the unit.



ELEPHANT CHAIN BLOCK CO., LTD.



Osaka, JAPAN

I) SAFE OPERATING PRACTICES

Improper operation of the electric chain hoist will possibly cause a dangerous situation such as falling of lifted loads, electric shock and so on. Carefully read this manual for proper operation before setting-up, installation, operation, maintenance and inspection of the electric chain hoist.

Do not begin to operate it before you have got familiar with its knowledge, safety information and all the special cares.

The cautions in handling the unit are classified into two levels in this manual;

 WARNING	This symbol is used to indicate that a death or serious injuries will be caused in all probability to the user or persons around when the products are improperly used.
 CAUTION	This symbol is used to indicate that damage may be caused to the user or persons around or only material loss will occur when the products are improperly used.

Even the matters indicated  "Caution" may bring a serious result depending on the situation. Strictly observe both the notices as they contain very important matters. Examples of the symbol:



-mark indicates that there are warning/cautious matters. In a sketch a concrete warning ("caution for electric shock" in case of the symbol on the left) is described.





-mark indicates actions to be prohibited. In a sketch or nearby a concrete warning is described.





-mark indicates that any action will be required or directed. In a sketch a concrete warning ("request for connecting an earth" in the case of the symbol on the left) is described.

※The manual must be kept in place where the operator can read it whenever he needs.



1. General

 WARNING	
<ul style="list-style-type: none"> ● The unit should be operated only by those who are familiar with the manual and contents of the instructing plate. ● The unit should be operated only by those who are formally qualified having completed training for operation of the crane, handling of the lifting slings, etc. according to the regulations in your country. The employer should keep unauthorized persons from operating the unit. 	
<ul style="list-style-type: none"> ● Inspection before operation and periodic inspection must be by all means carried out. 	

2. Installation and Setting-up

 WARNING	
<ul style="list-style-type: none"> ● The installation work should be performed only by the specialized contractor or experienced technician. ● The electric chain hoist should not be installed in a place deviated from the provision where it is, for example, exposed to rain or water. 	
<ul style="list-style-type: none"> ● Carry out an earth connection. Furthermore, an earth-leakage circuit breaker should be fitted to the electric line. 	
<ul style="list-style-type: none"> ● Attach a stopper to the ends of the traverse and travel rails. ● Make sure that a location on which the electric chain hoist is installed has a sufficient strength. ● Suspend the electric chain hoist in a manner that it can freely swing about. ● Attach a chain bucket to the electric chain hoist before installing it. 	

3. Operation and Handling

 WARNING	
<ul style="list-style-type: none"> ● Do not lift a load which exceed the rated load. <ul style="list-style-type: none"> ※The rated load is indicated on the hook block or on the nameplate of the electric chain hoist body. ● Do not get on a suspended load and do not use the electric chain hoist to lift, support or transport persons. ● Do not stay under a suspended load. ● Do not operate the electric chain hoist when somebody stays in an area where a suspended load is moved. ● Do not move a load over persons. ● Do not leave a suspended load unattended. ● Do not allow your attention to be diverted from operating the electric chain hoist. ● Do not operate the electric chain hoist in a manner that a load and/or the hook block swings away. ● Do not stop the electric chain hoist by always making use of the upper and lower limit switches. ● Do not use the electric chain hoist for the oblique pulling. <ul style="list-style-type: none"> ※First move the electric chain hoist to right over a load and then lift it. ● Do not use the electric chain hoist for the earth lifting (for example, lifting objects fixed under the ground). ● Do not carry out turnover of a suspended load. 	

※Turnover should be done by means of a device specialized in that purpose
(Such a turning device is available from us).

- Make sure before operation that the push-buttons properly function. Do not operate the electric chain hoist when the push-buttons are in disorder.
- Immediately stop operating the electric chain hoist when it moves in other direction as commanded by the push-button switch.
- Make sure before operating the electric chain hoist that the brake properly functions. Do not operate the electric chain hoist when the brake are in disorder.
- Do not use a electric chain hoist which was damaged or causes abnormal sound and/or vibration.
- Do not use a electric chain hoist with twisted, kinked ,damaged, severely worn, deformed, or elongated load chains.
- Do not apply the electric welding on a suspended load.
- Do not allow the load chain to be used as a ground for welding.
- Do not allow the load chain to be touched by a live welding electrode.

CAUTION

- Do not use the electric chain hoist at voltages other than the rated voltage in your country. 
- Do not use the electric chain hoist with a damaged safety latch of the hook.
- Do not operate the electric chain hoist by plugging (abrupt reversing) or frequent inching.
- Do not have the suspended load caught on other structures or cables.
- Do not have the push-button cord caught on other structures, or do not pull it strongly.
- Do not have the electric chain hoist body or trolley hit against stoppers or other structures.
- Do not use the load chain as a sling or do not wrap the load chain around the load.
- Do not bring the load chain into contact with sharp edges.
- Do not allow a load or slinging tools to push the chain bucket up.
- Never use the electric chain hoist at a load time rate and with a starting frequency exceeding the rated values.
- Do not use the electric chain hoist with name plates and labels attached to the body removed or left unclear.



- Make sure before operation that the bottom hook smoothly revolves. 
- Hang slinging tools properly on the hook.
- Stop lifting once when the load chain is properly tensioned.
- Always keep the push-button kit clean so that dust, sands and the like will not be

deposited on it.

- In the case of double electric chain hoisting, two electric chain hoists should be operated in a synchronized manner.
- Make sure that the range of lift of the electric chain hoist is sufficient for the intended work.

4. Maintenance, Inspection and Modification

WARNING

- Never make modifications to the electric chain hoist and its accessories. 
- Never use parts other than genuine ones made by us.
- Never do shortening or lengthening of the load chain.
- Before carrying out the maintenance, inspection or repair do not fail to turn the power source off. 
- Only specialists authorized by the employer may carry out the maintenance, inspection or repair.
- Carry out the maintenance, inspection or repair with the electric chain hoist unloaded (e.g. without loads).
- When any disorder is found in the maintenance or inspection, immediately make repair before re-operating the electric chain hoist.

CAUTION

- Whenever carrying out the maintenance, inspection or repair, set up a warning plate indicating “Under working” (“Under Inspection” or “Passing the current prohibited”, etc.). 

Notice:

- Inspections requiring dismantling and assembling of the unit should be carried out by dealers of our products.

TABLE OF CONTENTS

I) SAFE OPERATING PRACTICES	1
1. General	1
2. Installation and Setting-up	1
3. Operation and Handling	1
4. Maintenance, Inspection and Modification	2
II) APPLICABLE LAWS AND REGULATIONS	3
III) DESIGNATION OF ELEMENTS OF THE UNIT & SPECIFICATIONS	3
IV) IDENTIFICATION OF THE PRODUCT AND CAUTIONS FOR ITS INSTALLATION	5
1. Identification of the product	5
2. Cautions for using the unit in unusual circumstances	5
3. Operation time	5
V) INSTALLATION AND SETTING-UP	5
1. Electric wiring	6
2. Installation of the electric chain hoist	7
3. Connecting the cable and Fitting the chain bucket	8
4. Operation of the electric chain hoist equipped with a trolley	10
5. Checking after the installation and trial operation	11
VI) CAUTIONS FOR HANDLING	12
1. Proper handling and cautions	12
2. Cautions during operation	13
3. Other cautions	15
VII) MAINTENANCE AND INSPECTION	16
1. General	16
VIII) DAILY INSPECTION	16
1. Checking before operation	16
2. Checking by idle operation	17
3. Checking by rated load operation	17
IX) PERIODIC INSPECTION BY USER	18
1. Monthly inspection	18
2. Annual inspection	18
3. Durability of elements and parts	18
X) PROCEDURES FOR MAINTENANCE AND INSPECTION	18
1. Before making inspection	18
2. Checking the hook and its lifetime	19
3. Checking the chains and their lifetime	20
4. Checking the switch spring and its lifetime (both on load side and unload side)	21
5. Checking the chain bucket and its lifetime	21
6. Checking the chain stop bolt and its lifetime	21
7. Checking the chain stopper	21
8. Checking the push-button switch	22
9. Inspecting the trolley and its lifetime	22
10. Checking the motor brake and its lifetime	22
11. Adjustment and disassembly of over-load limiter of FAⅢ, FBⅢ and SAⅢ-type electric chain hoists	23
12. Checking the nameplate and tags	24
13. Wiring inside the body and fixing of the parts	24
14. Inspection of general functions and durability	24
XI) TROUBLE-SHOOTING	24
XII) CRITERIA FOR USING AND CHECKING ELECTRIC CHAIN HOISTS (BASED ON JIS B 8815)	26
XIII) WIRING DIAGRAM	28
XIV) EXPLODED VIEWS	30

II) APPLICABLE LAWS AND REGULATIONS

In accordance with the regulations of the laws (ordinances, rules, standards) in your country observe the provisions for the "Manufacture of Cranes", "Manufacture of Handy Elevators", "Structure Standards", "Operation of Cranes" and "Slings Work".

※It is above all advisable to investigate 1) legal obligations for installation; 2) those for usage and 3) those for inspection of the cranes and electric chain hoists respectively in laws (ordinances, rules, standards) in your country and to observe them.

III) DESIGNATION OF ELEMENTS OF THE UNIT

DESIGNATION OF ELEMENTS OF THE UNIT OF FA, FAⅢ, FB, FBⅢ, SA, SAⅢ TYPE ELECTRIC CHAIN HOISTS (example: with electric trolley)

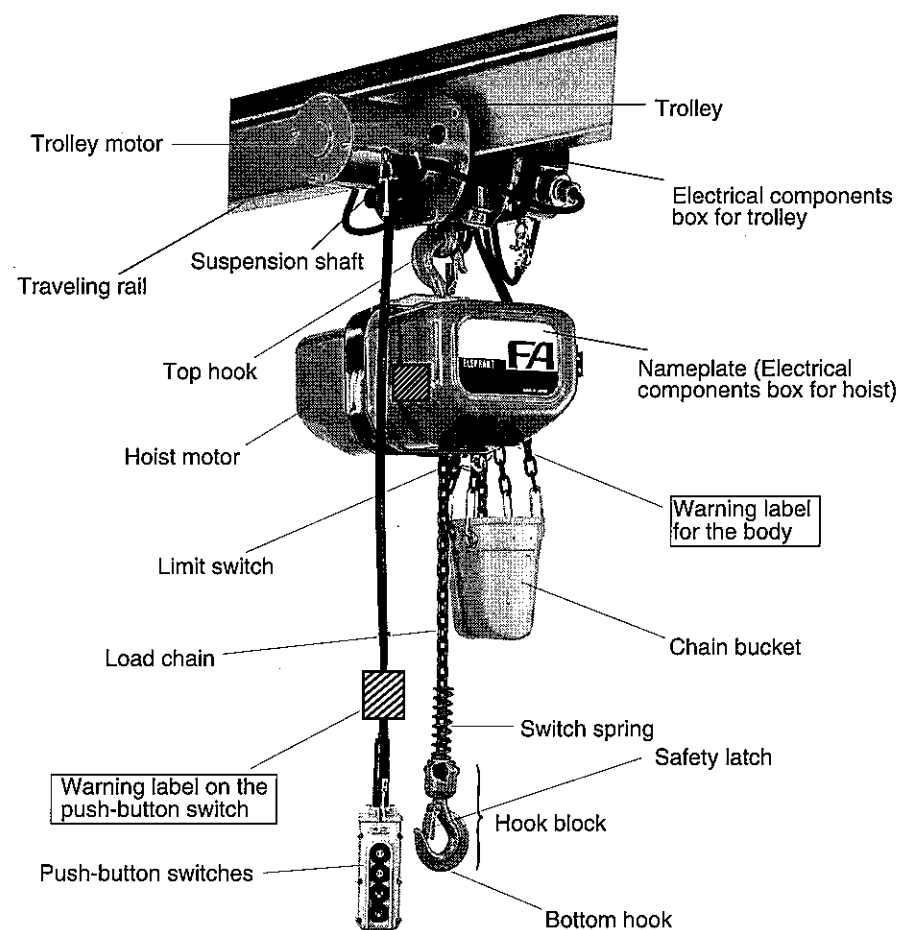

IV) IDENTIFICATION OF THE PRODUCT AND CAUTIONS FOR ITS INSTALLATION

1. Identification of the product

- Make sure that the electric chain hoist delivered is in accord with your order.

1-1 Electric chain hoist

- 1) Type Check for the type (Nameplate as well)
- 2) Power supply Single phase 100V/220V or 3 phase 200V/380V (or extra voltage)
- 3) Rated load Check for the rated load
- 4) Range of lift 3m or 6m etc.(or extra height)

1-2 Trolleys (package)

- 1) Type Plain, Geared, or Electric trolley
- 2) Rated load Check for the rated load

1-3 Push-buttons (package)

- 1) Number of push-buttons 2, 4 or 6 etc.
- 2) Length of the push-button cord 2.5 m or 5.5 m (or extra height)

1-4 Power cord (package)

- 1-5 Length of the power cord 5 m (1m for the electric trolley)

※Check the unit for its lifting height or cord length respectively when an extra lift or a cord with a special length is ordered.

- Check the unit for damages during transport and/or other damages.
- Check the goods for its complete delivery of accessories and documents concerned.

List of accessories and documents.

Operation manual of the electric chain hoist	1 copy
Operation manual of the trolley (when purchased)	1 copy
Inspection certificate of the electric chain hoist	1 copy
Chain gauge	1 piece
Chain bucket	1 set

Consult a dealer of our products immediately if any disorder is found.

2. Cautions for using the unit in unusual circumstances

WARNING

- The electric chain hoist may not be used in an explosive environment.
 - ※Area where organic solvents or explosive dusts exist
- The electric chain hoist may not be used in areas where extremely low or high temperatures, high humidity or chemicals dominate.

Consult a dealer of our products when the electric chain hoist is used in a special environment where low (under -10°C) or high temperatures(over 40°C), high humidity(over 90%), much acids or salts, or much chemicals dominate. Install a shelter protecting the body of the electric chain hoist against wind, rain, snow, etc. or apply a cover over it when it is used outdoors.

 - ※It is necessary to employ a one rank heavier model especially in a cold condition, because metals will possibly get brittle.

3. Operation time

CAUTION

- Do not use the electric chain hoist in a working condition that exceeds the rated duty cycle and the maximum starting frequency.



	FA, FAⅢ, FAH, FAHⅢ types	FB (4·6), FBⅢ (4·6), FBH (4·6), FBHⅢ(4·6) types	SA and SAⅢ types
Duty cycle percentage (% ED)	40 %	30 %	25 %
Max. starting frequency (times/hour)	240	180	150

Table 1

Load rate	Mean running time per day (hour)					
	< 0,25	< 0,5	< 1	< 2	< 4	
Light						Operation usually at 1/3 of rated load and occasion-ally at rated load.
Middle						Operation usually at 1/3 to 2/3 of rated load and occasion-ally at rated load.
Heavy						Operation usually at 2/3 or over of rated load and often at rated load.
Extremely heavy						Operation mostly at or nearly rated load

※SA and SAⅢ types should be used in a range of areas.

※FA, FAⅢ, FB and FBⅢ types should be used in a range of areas.

- The lifetime of the product is highly dependent on the load applied and the operation hour.
- To achieve its longer lifetime the electric chain hoist should be operated in a hatched range of time in Table 1.
 - In the following cases consult us or a distributor of our products.
- 1) The electric chain hoist will be possibly operated in a condition exceeding the hatched range.
 - ※Sufficient maintenance such as periodic inspection, etc. will be necessary.
- 2) The electric chain hoist will be operated in a very severe and concentrated working condition.
 - ※It will be caused that the motor is over-heated or the load setting for the friction clutch is reduced.

V) INSTALLATION AND SETTING-UP

WARNING

- Refrain from installing the electric chain hoist by yourself and leave the installation work to the care of a specialized contractor.
 - ※Otherwise you might be wounded by electric shock or the electric chain hoist fallen.
- Do not fail to conduct an earthing. Furthermore, a leakage circuit breaker should be installed in the electric path.
 - ※Above measures are absolutely necessary for avoiding an accident by electric shock.



※Conduct earthing and fitting of the said breaker in accordance with regulations valid in your country.

- Make sure that a place where the electric chain hoist is installed has a sufficient strength.

※Otherwise persons might be wounded by the electric chain hoist fallen, etc.



Concerning the installation, consult us or a distributor of our products.

1. Electric wiring

Leave the electrical work to the care of a specialized contractor, who should properly carry out the work observing this instruction manual.

Carry out the electrical work in accordance with the technical standards on the electrical equipment and regulations for the internal wiring in your country.

- Before connecting the power source to the electric chain hoist, make sure whether its voltage complies with the applicable source for the electric chain hoist.

1-1 Connecting the power cable

⚠ CAUTION

- Conduct the connection of the power source via the switch cabinet (main circuit breaker).
- Shut off the switch cabinet while the electric chain hoist is not operated. (Otherwise eventual leakage current may cause electric shock or fire.)



- (1) Make use of a three phase power source for the electric chain hoist types FA, FAⅢ, FB and FBⅢ, and a single phase for SA and SAⅢ types.
- (2) Carry out the wiring according to Fig. 1. Connect the S line (white) of the power cable to the S line of the power source.
- (3) Connect the yellow/green line (earth line) to the earth.

⚠ WARNING

- In the case of negative phase, do not change the wiring inside the push-button switch and the main body.
- ※It may cause limit switches to get out of function, resulting in a very dangerous situation.



Fig. 1

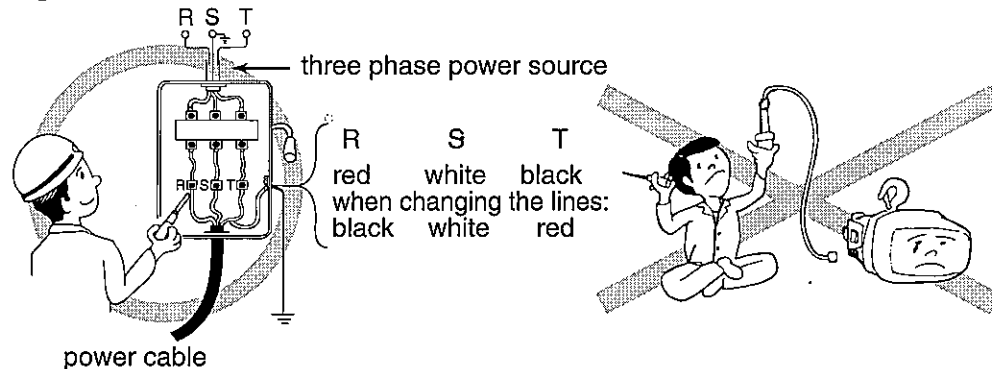

- When the electric chain hoist does not operate while the breaker is put on and a push-button is pressed, the electric chain hoist is being blocked by the function of "negative phase protection device". In such a case, put the breaker off and change the T-line (black) with the R-line (red) on the cable side as shown in Fig. 1. The electric chain hoist will then properly operate. (Make sure that the S-line is connected to the earthed phase of the power source.)
- In case of the SA or SAⅢ type electric chain hoist for single phase power source, use a plug with earth or a plug with a separate earth. Otherwise consult an electrical constructor about a main switch with ON and OFF contacts.
- ※Make sure if the current capacity on the plug socket side is sufficient.

1-2 Selection of the power cable

⚠ CAUTION

- Avoid to use a power cable which is too small in diameter and to connect a power cable to the mains of which voltage has been dropped.
- ※Otherwise the electric chain hoist will not operate properly or the power cable may be heated and burnt.
- ※In the case of the single phase electric chain hoist, the governor switch would make noise or be burnt to break.



If the resistance (Ohm) of the cable from the mains to the electric chain hoist or other supply lines is too high, voltage (volt) of the power source will remarkably drop, causing the electric chain hoist to improperly operate or the supply lines to be burnt. Select such a supply line as its calculated value for voltage drop does not exceed a value of 4V (in case of single phase, 2V).

Calculation of voltage drop

Example:

3 phase, 200V

Voltage drop = $30.8 \times L \times I \div A \div 1000$

single phase, 100V

Voltage drop = $35.6 \times L \times I \div A \div 1000$

here, L=cable length (m),

I=steady-state power consumption (A),

A=cable section (mm²)

Fig. 2

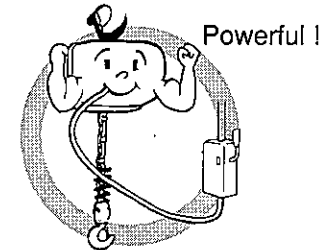

Fig. 2: Good cable

Big in diameter = resistance per meter is small

Short in length = advantageous condition

Fig. 3

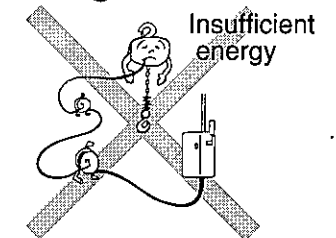

Fig. 3: Wrong cable

Small in diameter = resistance per meter is big

Long in length = disadvantageous condition

Table 2

			Steady-state power consumption
FA and FB	490kg • 0.5t	Without an electric trolley	4 A
	0.9t • 1t		7 A
	2t		
FA and FB	2.8t • 3t • 5t	With an electric trolley	7 A
	490kg • 0.5t		10 A
	0.9t • 1t		14 A
SA	250kg	Without an electric trolley	
	490kg • 0.5t		12 A
	0.9t • 1t		

1-3 Power supply for the electric chain hoist, delivered with a trolley attached

- The power supply for use in connection with the geared trolley or plain trolley is to be done in a same manner with this operation manual.
- As to wiring between the electric trolley and the electric chain hoist when they are used as one unit, refer to the operation manual of the electric trolley.
- The travel rail must be absolutely earthed.
- For better conductivity the travel face of the travel rail and the wheel face should be kept free from paint, oil and the like.

2. Installation of the electric chain hoist

⚠ WARNING

- An installation site should be prepared in such a way that the electric chain hoist will never fall down. 
- The electric chain hoist should be hung down so as to freely swing away.
※ Otherwise the fixed portions will be severely stressed and persons may be wounded by a dropped electric chain hoist being caused by damaged elements.

In case that the electric chain hoist is used only for lifting and lowering, the metal fixture to support the top hook should be properly constructed and be made of suitable material so as to secure in the lifting condition a safety factor 5 times and higher than the rated load.

2-1 Cautions before operation

Observe the following points to properly use the electric chain hoist before switching on and operating it. When erroneously used, the load chain and/or other elements may be damaged by a strong force of the motor.

Fig. 4

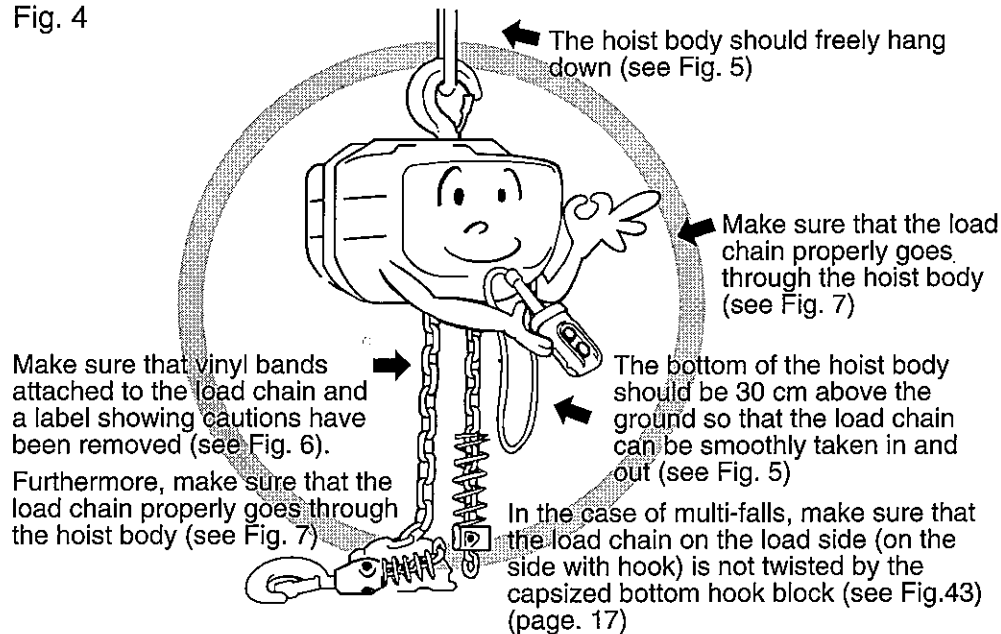

⚠ WARNING

Never operate the electric chain hoist when it is not hung down or it is extremely tilted. 

Fig. 5



The electric chain hoist should be operated only after vinyl bands and a "label showing cautions" have been removed. Otherwise the load chain will be improperly moved to have parts damaged. 

Fig. 6

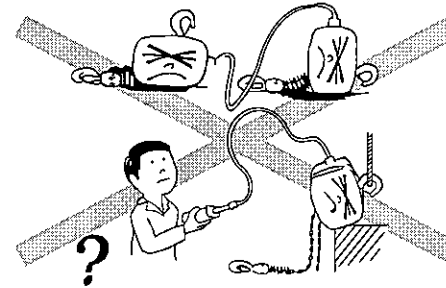

The vinyl bands are fitted to prevent such an unusual state of the load chains during transportation as illustrated below. Such state can be occasionally caused, when the body is laid on the ground or it is nearly turned up after removal of the vinyl bands. Whether such state has been caused or not can be checked by strongly pull the load chains one by one underneath the operating members A and B respectively. If the load chains normally pass through the body, the chains and the operating members will not move up or down even when the load chains are strongly pulled. It is a sign of existing abnormality when the chains and the operating members move. Such state must be absolutely put in order before operation, that is, by strongly pull the load chains with quick scoops. 

Fig. 7

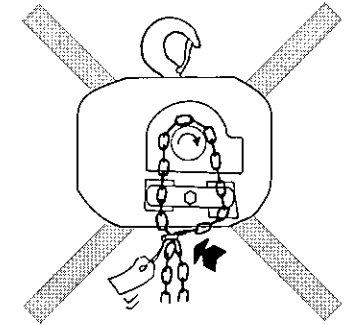

3. Connecting the cable and Fitting the chain bucket

⚠ CAUTION

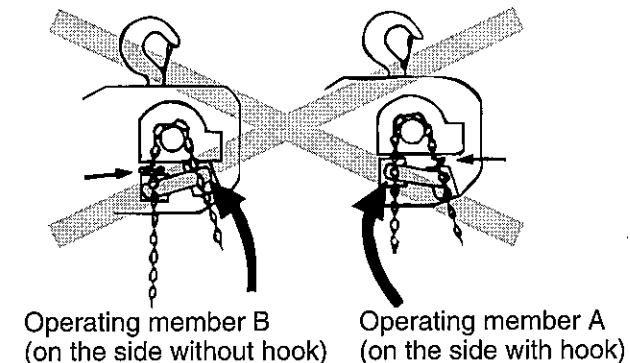
- Erroneous fitting of the connectors may possibly cause the cable to be disconnected or the connectors to be damaged.
- ※ Thoroughly read the following instructions to make proper connection.



3-1 Connecting the plug

When fastening the resin nut ;

- Do by holding the cord with fingers so that it may not excessively turn.

Fig. 8

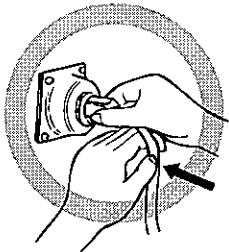

Turning of the cord should be stopped by the other hand.

Fig. 9

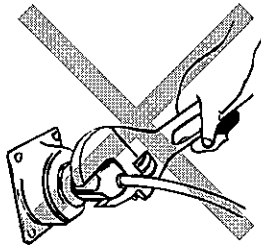

Fastening by using tools like monkey wrench, spanner etc. will damage threads of the resin nut.

Fig. 10

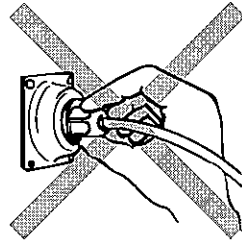

Fastening the nut with the cord not held may twist internal wires, causing them to be broken.

3-2 Connecting the power cable and the push-button cord (without the electric trolley)

- Designation of elements

Fig. 11

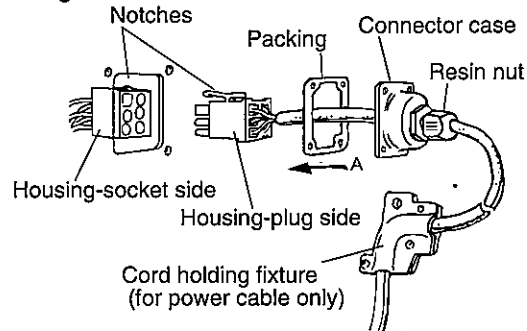

- Connecting procedure

- (1) Loosen the resin nut at the back of the connector case.
- Thus, the cord can be easily moved.
- Pull the cord out in "A" direction so that the plug may be easier inserted.
- (2) Before connecting the housing, place the packing at the illustrated position.
- (3) Insert the plug into the socket of the housing, confirming that

the matching notches have been securely engaged. When connecting, the both notches may be engaged each other by simply pushing the plug into the socket, but when disconnecting, push down the back of notch on the plug side to raise the tip of the notch and to pull the plug out.

- (4) Bring vis holes of the connector case into line with those of the packing, push them together and fix them by 4 vises with spring washers. Fix also the hanging fixture for the push-buttons by 2 vises with spring washers.
- (5) Fasten the resin nut.
 - Remember that excessive fastening may damage the nut.
 - Don't fasten the nut by tools but with fingers only. When fastening the nut, the cord tends to turn together. Excessive turning of the cord may damage it.
 - Fasten the nut by holding the cord with other hand so that it may not turn.
 - Make setting in such a manner that the cord is not twisted 90 degrees and more than the natural state.
 - Proper setting can be easily made by turning the cord beforehand in anti-clockwise direction by approx. 90 degrees, as the cord tends to turn in clockwise direction. (This applies also to the power cable and the push-button cord.)
- (6) Owing to the steps as mentioned above, the portions connected will be completely water- and dust-proofed. When the cord is strongly pulled, the cord will be, however, taken out of the case or broken. For preventing such troubles, a holding fixture for the cord is delivered with the power cable. Properly fix the holding fixture. Such a holding fixture is not set for the push-button cable, which instead has a wire as integral part. Fix the wire firmly to the hanging fixture for the push-buttons by vises with spring washers.

Fig. 12

Hanging fixture for the push-button cord
Fixing position and View of the fixture completed

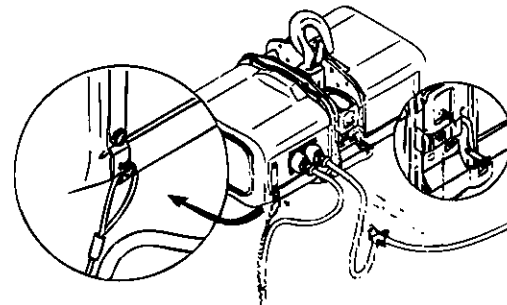
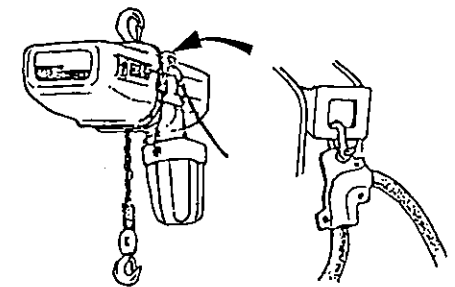

Fig. 13

Holding fixture for the power cable
Fixing position and View of the fixture completed



3-3 Connecting the push-button cord in using the electric trolley

(1) The electric trolley is equipped with a push-button holder shown in the figure. Screw the push-button holder with a nut in the tap hole at the right below of the side-plate on the motor side of the trolley (replacing the spring washer with the nut is required). Insert the holder up to the position where its leading end does not contact the gear wheel and the ring at its trailing end stands vertically (the leading end should reach the inner face of the side-plate on the motor side, as the insufficiently inserted holder may be deformed). Then, fasten the nut in the direction of the side-plate on the motor side to fix the holder.

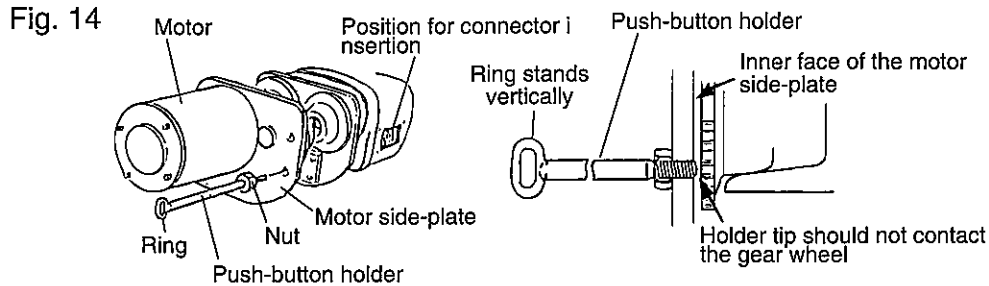

(2) Fix the push-button cord to the ring of the holder by using the accessory shackle.
 (3) Connect the connector of the push-button cord to the trolley (As to connecting the cord, refer to the connecting procedure for the power cable).
 (4) Adjust the suspended length of the cord between the connector and the ring of the push-button holder. An excess of the push-button cord should be put together in a loop in the vicinity of the ring, because the cord with a big dip under the trolley may be possibly damaged by swinging of the suspended chain hoist. Bring the cord into loop in the vicinity of the ring and set the suspended length of the cord proper by adjusting the loop size. Bind the upper portion of the loop to the push-button holder with accessory vinyl band to complete the connection work.

Fig. 15

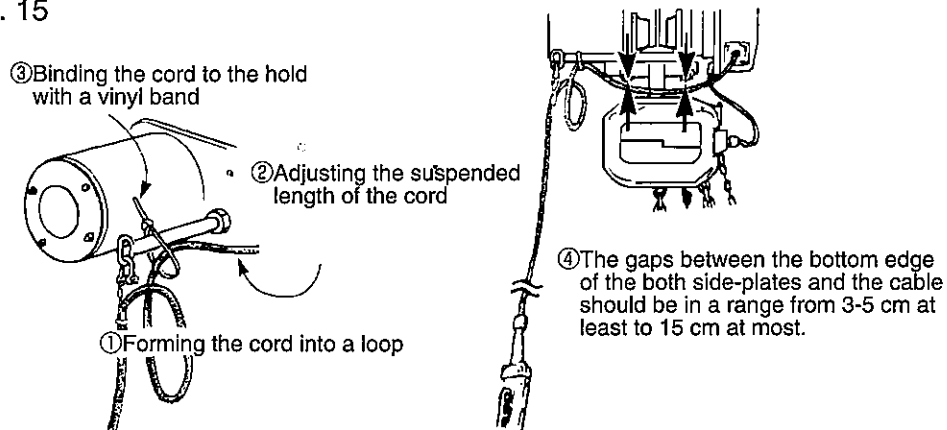

3-4 Fitting the chain bucket

WARNING

- Fit the chain bucket before installing the electric chain hoist.
- ※ If the chain bucket is not fitted, the load chain on the unload side may possibly catch a load and other objects, as is quite dangerous.
- ※ Make sure that the chain bucket is properly fitted, because its falling from a higher position during use is quite dangerous.

Fig. 16

The load chain in idle which does not undergo any tension when applying a load is called the load chain on the unload side.

Fig 17

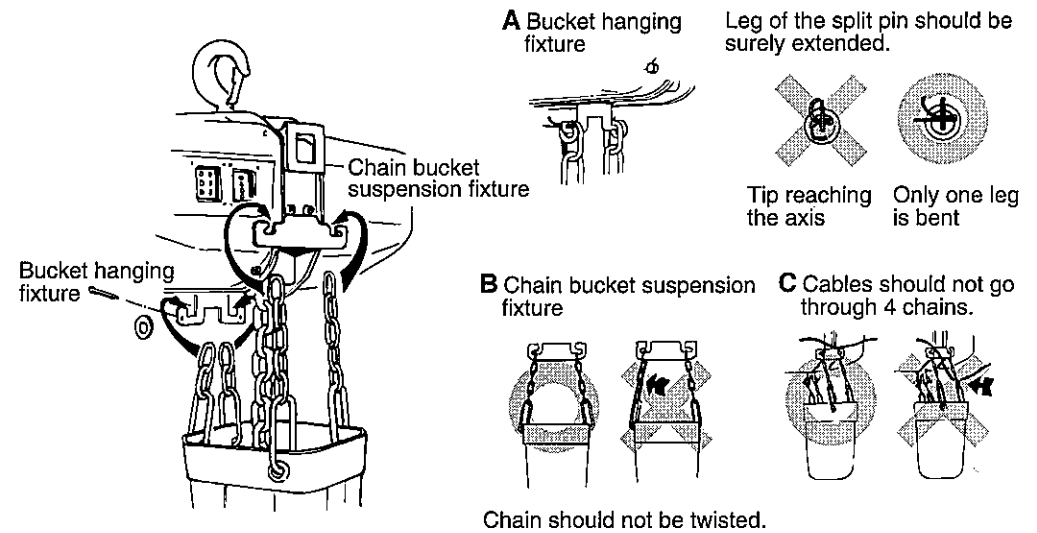

CAUTION

- The chain bucket should not be pushed up by a suspended load, etc.
- Use a chain bucket only which complies with the length of the load chain.
- Do not put the load chain at once into the chain bucket.

- Fit the chain bucket in a state that approx. 50 cm only of the load chain on the unload side comes out of the body (See Fig. 18). It not only eases the fitting but enables also the load chain to be put into the chain bucket in quite good order.
- Keep the chain bucket being hung from the body of the electric chain hoist in a natural state without undergoing any force.
- Avoid that the bucket will be pushed up by a suspended load, etc. (See Fig. 19). Otherwise the load chain may burst out of the bucket or it can hardly pass through the electric chain hoist, as is quite dangerous.
- It is also dangerous when the chain bucket is too small for the length of the load chain. The bucket must be also exchanged according to Table 3 when the load chain has been exchanged with a longer one.

Fig. 18

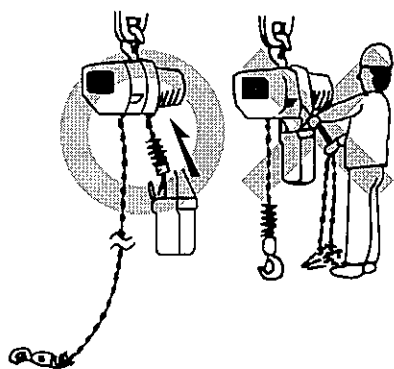

It may happen that chains are entangled or kinked.

Fig. 19

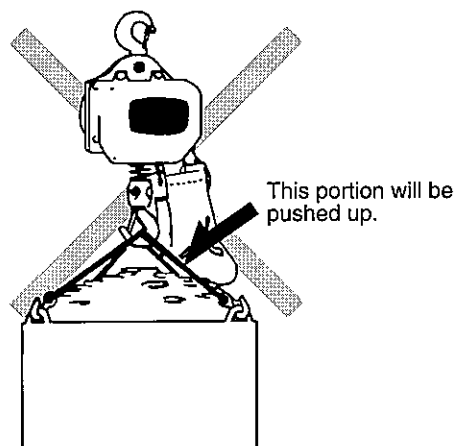

Table 3 List for the chain bucket to be selected

(meter)

Bucket No.	250 kg, 490 kg, 500 kg standard lift	0.9 t, 1 t standard lift	0.9 t(W), 1 t(W) standard lift	2 t standard lift	2.8 t, 3 t standard lift
1	4 and less	4 and less	—	—	—
2	8 and less	6 and less	3 and less	3 and less	—
3	12 and less	10 and less	5 and less	5 and less	3 and less
4	18 and less	15 and less	7.5 and less	7.5 and less	5 and less
5	35 and less	30 and less	15 and less	15 and less	10 and less

(Remark) The load chain will burst out of the bucket when the electric chain hoist is used in a site where much dust is floating or foreign matters may enter into the bucket. It is therefore very important to always clean the bucket and the chain and to apply oil to the chain.

4. Operation of the electric chain hoist equipped with a trolley

⚠ WARNING

- Insert the same number of pieces of adjusting collars on both sides of the connecting fixture. If they are inserted on one side only, a load is not uniformly applied, causing a dangerous situation such as abnormal movement of the trolley or its falling, etc.
※As to further details, refer to the operation manual of the trolley.



4-1 How to fit the trolley to the traversing rail

- The trolley can be fitted to the rail, being adjusted to several different widths of the traversing rail by shifting adjusting collars only.
- Insert the same number of pieces of adjusting collars on both sides of the suspension (connecting) fixture of the electric chain hoist.
- Avoid improper setting shown in Fig. 20 (marked with X) which may result in serious accidents

Fig. 20

Connecting fixture

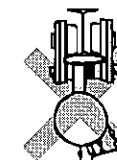
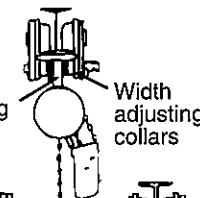

4-2 How to fit the trolley to the curved traversing rail

In the case that the electric trolley or the electric chain hoist with a geared trolley is fitted to the curved traversing rail, its motor or hand chain wheel side should be outside the rail curve. If they are inside the rail curve, the traversing rail or the wheel gear of the trolley may be possibly damaged.

In the case that the traversing rail has curves in both the right and left directions, the trolley should be fitted in such a manner that the above-mentioned instruction applies to a smaller curve (Refer to Fig. 21).

Fig. 21

With electric trolley

With geared trolley

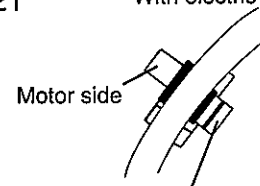

Hand chain wheel

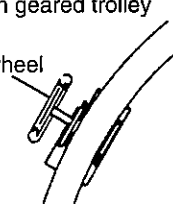

Electrical components side

4-3 Traversing rail and stoppers

⚠ WARNING

- For avoiding eventual falling of the electric chain hoist and the trolley, mount a stopper at the rail ends.
- Avoid stopping the trolley by hitting it against a stopper.



A portion of the traversing rail contacting with trolley wheels should not be painted but be polished when it is rusted.

● Joints of the traversing rail

- (1) Joints of the traversing rail should be located in the vicinity of supports for the rail.
- (2) In the case that a backing plate is welded on the side or bottom of the rail (See Fig. 22), a plate with suitable thickness must be selected. If too thick a plate is attached, the trolley will hit it and be unable to pass through the point in the worst case.
- (3) Staggered joints must be aligned within 0.5 mm in both horizontal and vertical directions. The portions on which the trolley wheels travel should be finished by a grinder (See Fig. 23).

Fig. 22

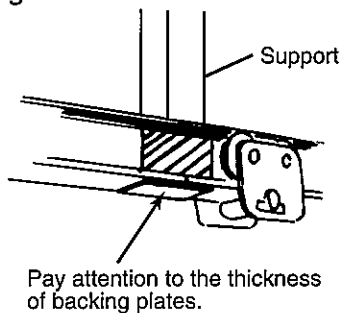
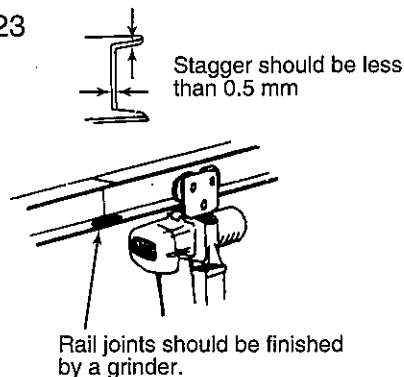

Fig. 23



● Anti-falling stoppers at the rail ends

- (1) For avoiding that the electric trolley will hit a wall, etc. even when it hits the stoppers with a higher speed or the electric chain hoist swings, a distance (a) shown in Fig. 24 should be sufficiently wide.
- (2) The stoppers should be firmly secured so as to withstand the impact and be covered with a shock-absorbing material like rubber, etc. (See Table 4 and Fig. 24).

Fig. 24

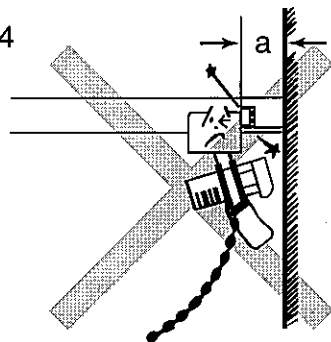

- Avoid such an installation as the trolley always stops by running against the stopper.

Table 4 Stoppers

Dimension of the traversing rail (mm)	150×75	200×100	250×125	350×150	450×175
Angle steels (mm)	L50×50×6		L65×65×6	L75×75×6	L90×90×7
A (mm)	20		30	35	45
B (mm)	50				
C (mm)	M16				

Fig. 25

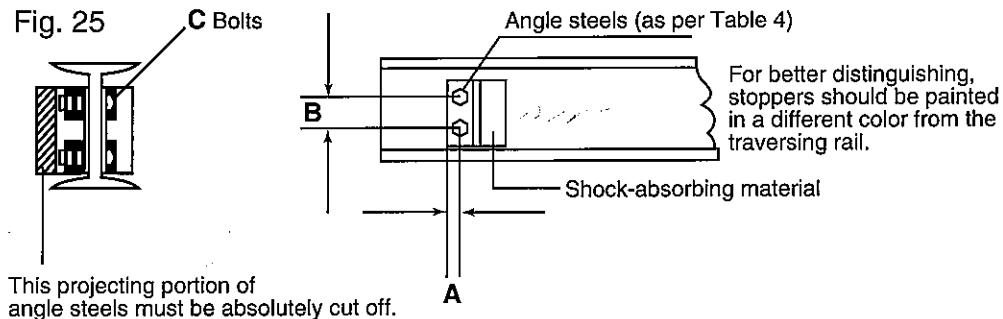

5. Checking after the installation and trial operation

Make sure the following points after installation of the electric chain hoist.

- (1) Checking before operation
 - (2) Checking by idle operation (without loads)
 - (3) Checking by normal operation with a rated load
- As to the checking and the trial operation, refer to "Daily inspection" (page 16).
 - When the following occurs in checking the lifting action without a load, negative phase is expected.

⚠ WARNING

- When an operation is impossible, put the master switch off, check the power lines R and T and change each other.
 - ※ Never change the internal of the push-button switch and the wiring inside the electric chain hoist body. It is quite dangerous.



- Do not operate the electric chain hoist when the load chain is kinked, tangled or twisted.
- In the case of the multi-falls, make sure that the chain is not capsized (See page 17).



- In the case of the single phase electric chain hoist, stop the operation when unusual noise could be heard from the governor switch of the motor. This results from the voltage drop.
 - ※ If the voltage is not correct, the motor could be burnt.
- For avoiding tangled chain (inside packaging) during transport, chains are bound with wires in some models. In this case, the wires must be completely removed before operation.
 - ※ Be careful that wire chips, vinyl and a "label showing cautions", etc. will not be pulled in the electric chain hoist.

Fig. 26

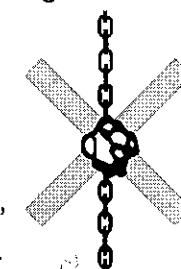

- Do not operate the electric chain hoist in such a manner as the over lifting protection device for "over-lifting" and "over-lowering" will be always brought in action.
 - ※ The over-lifting protection device should be regarded only as an emergency device and cannot be used forever.

After installation, measure dimensions of the opening of the bottom hook and its portion on which the wire rope is applied and record them.

※Such records will be required for comparing hook opening, wear, etc. in inspecting the bottom hook.

VI) CAUTIONS FOR HANDLING

⚠ WARNING

- The unit should not be operated by persons who have not fully understood this manual, instructions or plates on the unit.
- Persons who have not been formally qualified according to the regulations in your country should not be allowed to operate a crane and engage in slinging work. The employer should keep unauthorized persons from operating the unit.

1. Proper handling and cautions

1-1 Slinging tools

⚠ CAUTION

- Inspect all the tools to be used on the day before use.
 - ※Inspect the tools and decide its disposal conforming to laws and ordinances in your country.
- Use slinging tools most suitable for shape of loads for safety.
 - ※For reference, safety factors for slinging chain, wire rope, and belt sling should be at least 5, 6, and 6, respectively.

1-2 Safe and reliable slinging

Be careful to choose slinging tools of proper capacity and length. Check for the manner of slinging as well as the weight of a load. The tool should not be hung incorrectly as shown in Fig. 27.

Incorrect handling example 1:

Slinging a load with a slinging tool set on an improper point of the hook will move the tool and add a dangerous shock load on it. Lower the load and remove the tool to hang the load again.

Incorrect handling example 2:

Too wide a slinging angle will increase a force on the slinging tool, and may cause a broken latch and a falling load. Change the slinging point, or use a long slinging tool if it is allowed. The slinging angle shown in the figure should be within 60 degrees.

Incorrect handling example 3:

The slinging tool is so thick that the latch cannot return in place. Change the tool, or use a chain sling with metal fixtures (Consult the dealer from whom you purchased the unit about proper tools for more efficient operation).

Fig. 27

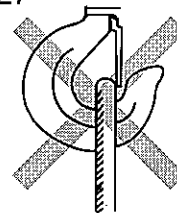

Incorrect handling example 1
(slinging tool hung on hook end)

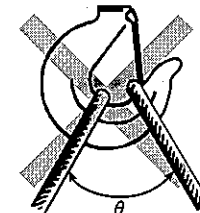

Incorrect handling example 2
(too wide slinging angle)

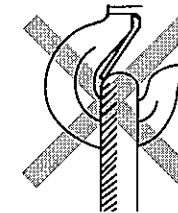

Incorrect handling example 3
(too thick slinging tool)

⚠ CAUTION

- Never wind a load chain directly around a load regardless of its weight. It is quite dangerous.
- Never use the unit with a broken latch of the hook. The latch should be maintained to always function properly. Check that it functions as intended in slinging work (Fig. 28).

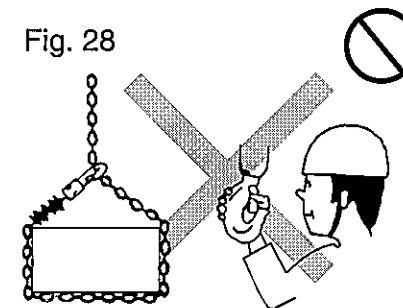

1-3 When starting lifting

After setting a slinging tool, be sure to check the following three points before lifting high.

- Check for the slinging condition with the load chain of the electric chain hoist or the slinging tool kept tense.
- Lift the load slightly to check a balanced lifting.
- Check that the brake of the electric chain hoist functions reliably by winching up and down for dozens of centimeters repeatedly.

Fig. 29

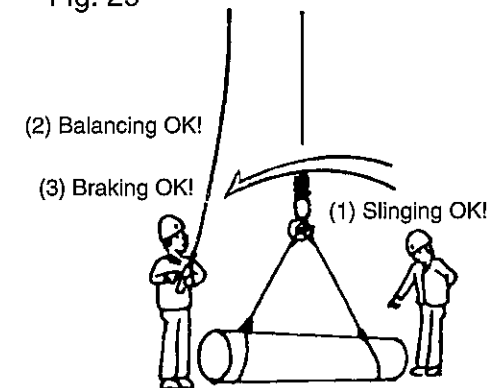

Make it a rule to always check the said three items before lifting a load to higher position (refer to Fig. 29)

- If some noise could be heard from the governor switch during winching up and down of the single phase electric chain hoist, do not continue to operate it and check the following.
 - ※The power cable may be too small in the diameter. It happens voltage drop or overloading on the hoist.

2. Cautions During Operation

2-1 Lifting and lowering a load

WARNING

- Never lift a load beyond the rated load of the unit.
※It will cause damages to the unit and a load fall. It is very dangerous.



CAUTION

- Do not swing away a load during lifting and lowering.
- Do not swing away the electric chain hoist even without loads.
※The load may fall, or the chain may be damaged.
- Do not pull the electric chain hoist in oblique (vertical, horizontal) direction. Always move the electric chain hoist right above a load, and lift it.
※Oblique pulling is dangerous because a load will be pulled suddenly and strongly when it leaves the ground, and because an oblique force is imposed on the structure supporting the electric chain hoist (Fig. 30 and 31).
- Do not lift a load by double hoisting. It is very dangerous.
※Should you be compelled to do so, have an experienced operator work and confirm the following points (to prevent load inclination, etc.):
※Choose either a method of synchronizing two hoists or two-point horizontal suspension electric chain hoists.
※Use two hoists with the same lifting speed.
※Install a collision preventive device or the like lest the two hoists should collide.
- In lifting a load with two hoists, they will bear much larger load than expected when the load chains crosses at a large angle with the plumb line, or when the center of gravity of the load is close to either of the lifting points extremely (Fig. 32).
※In addition, abrupt running of a trolley and other risks are probable.



Fig. 30

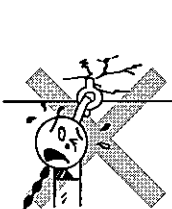

Fig. 31

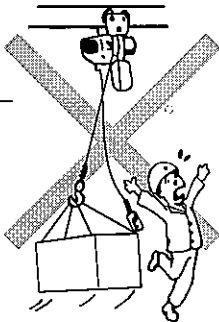
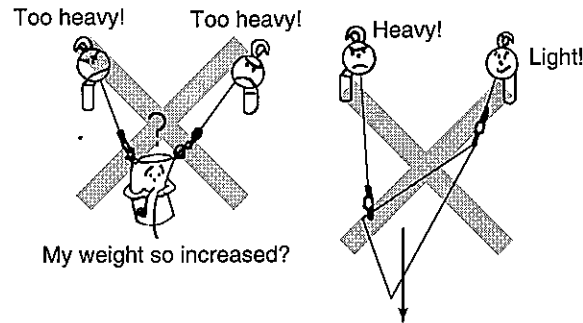

Fig. 32



CAUTION

- Stop lifting once when the chain becomes tense to check safety.
※The chain will less likely to be damaged because such a pause will alleviate a shock instantly imposed on the chain when a load flies.
- Never do earth lifting (e.g. hanging a load on a building structure etc.).
※An excessive force on the unit will damage its elements.
- The over-lifting/lowering protection device is a safety device. Thus, do not operate this unit in such a way as to activate frequently the over-lifting/lowering protection device.
※The limit switches will be worn, causing possibly that they will be inactive in an emergency.
※The over-lifting/lowering protection device cannot permanently be used and it is therefore necessary to execute the unit in such a manner that the function of the protection device incorporated in the electric chain hoist will be limited to emergency only by any suitable means, for example by installing extra limit switches in the system.
※For checking the function of the over-lifting/lowering protection device at the upper and lower limits, activate the upper and lower limit switches several times without load (no loads suspended) before commencing the work on the day.
- Do not make a load and a slinging tool hit the chain bucket.
※The chain may overflow, or the chain bucket may be damaged.
- Do not invert a lifted load. To invert it, use another electric chain hoist exclusively for inverting.
※Otherwise, an abnormally large impulse may generate.
- Do not use the electric chain hoist when it touches some objects, or when it is fixed.
※Be sure that the hoist is used in a normal suspension state free from any force.
※The electric chain hoist is designed to be freely suspended from a hook or a trolley and to swing slightly as a polygonal sheave (an element which transfers driving force to the load chain) rotates.
- ※Do not obstruct this spontaneous swing; otherwise, unforeseen forces will be added on various elements, and are very dangerous (Fig. 33).



Fig. 33

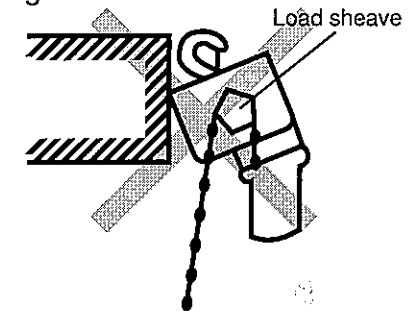

2-2 Moving a load (traverse movement)

CAUTION

- Do not allow any person to pass and stay right under a suspended load and in a load traveling direction (Fig. 34).
※ The load may hit a person, as is very dangerous.
- Do not let the electric chain hoist and a trolley collide with a trolley stopper and building structures.
※ The suspended load will fall.
※ Pay special attention when the trolley approaches the stopper so that the trolley can stop of itself before it hits against the stopper (Fig. 35).
- Do not pull the push-button switch cord to roll the trolley (Fig. 36).
※ The cord may rupture.
- Do not hang the hand chain of the geared trolley on a suspended load and the loading platform of a truck.
※ If the hand chain of the geared trolley is pulled strongly while it is caught by the load and the loading platform, the trolley may deform or fall.
※ Be careful in handling the hand chain of the geared trolley (Fig. 37).

Fig. 34

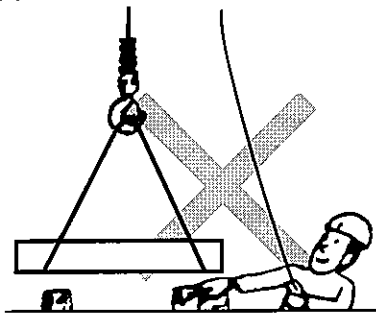

Fig. 35

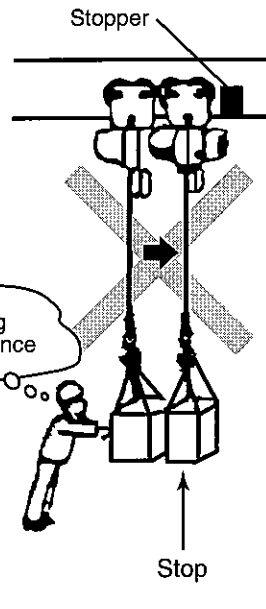

Fig. 36

Undue burden on a cord

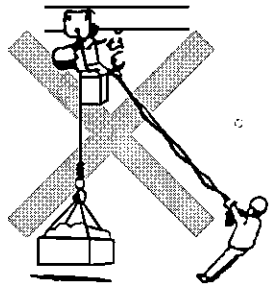
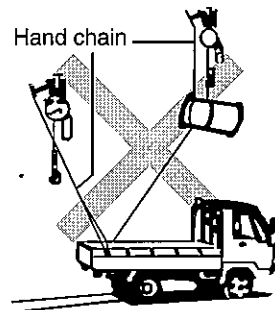

Fig. 37



2-3 Operating the push-button switch

- Check before lifting that push-buttons function properly.
- Be sure to press push-buttons to the end.

CAUTION

- Stop the operation if the chain hoist conducts a movement in the reverse direction from the designation by the push-buttons.
※ Check the wiring (See page 6) again, or consult the dealer of our products.
- Do not suddenly move a load to the reverse direction (plugging).
※ Wait until the load stops and then move it to the reverse direction.
※ Plugging will momentarily impose twice as much as load on the electric chain hoist, or damage a motor and electrical components.

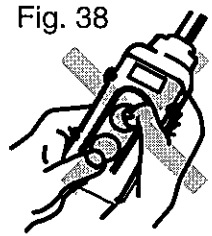

⚠ CAUTION

- Avoid frequent inching operation.
※ Inching operation and collision of a load during movement will generate larger momentous tension of the load chain than that in normal use.



- ※ Inching operation will wear the brake and contacts of electrical components and overheat a motor. If frequent vertical inching operation is unavoidable for the positioning work, etc., use a hoist with the dual speed type (F4B, F6B types).

Fig. 39

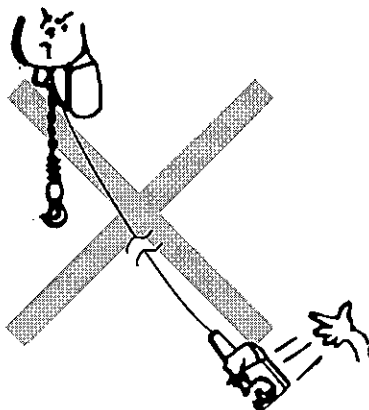

- ※ The push-buttons of the dual speed type hoist can be pressed on two levels; the first level is for low speed hoisting and the second is for high speed hoisting.

- ※ Our dual speed type hoist has a special circuit to keep its life long. This may cause a slow start after operating the push-button in such cases; e.g. 1. when pressed down to, the second level at a stroke, 2. when changing the speed type. This is however not a fault. Wait a little while.

- ※ Do not make frequent change-over between the high and low speeds.

- After use, bring the push-button switch unit under the electric chain hoist before releasing it (Fig. 39) to prevent unforeseen damages or malfunction.

- Always clean the push-button switch unit so that dust, sand, etc. are not deposited on it.

- ※ When the casing of the push-button switch unit is broken, or internal parts fall out, or foreign matters adhere to the unit, replace it with a new one to avoid electric shock or malfunction.

- A reinforced plastic casing for the push-button switch unit may deform when exposed to heat.



- ※ Therefore, an aluminum-cast casing is preferable. For replacement, consult a dealer of our products (An aluminum-cast casing should be earthed properly.)

2-5 For safe operation

⚠ WARNING

- Never leave a load suspended.
- Do not distract your attention from a load during operation.
 - ※ Keep any person apart from the load.
 - ※ The hoist operator should not leave the load as long as it is suspended (Fig. 40).
 - ※ While the load is lifted, a qualified operator should watch and control the safety of the load and the working site.



- Never climb and work on a suspended load.
 - ※ The suspended load is unstable, and a person or the load may fall.

Fig. 40

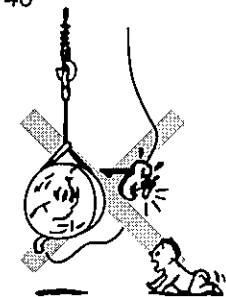

- Avoid moving a load over persons.
 - ※ It is dangerous, should it fall.
- When the electric chain hoist is not used, the bottom hook should be brought far above your head.
 - ※ Leaving the bottom hook low may hit workers on the head, etc.

3. Other Cautions

⚠ WARNING

- Allow only persons who have received a necessary training to operate the hoisting unit.
 - ※ It is extremely dangerous to charge untrained persons with the operation.
- Never tamper the hoisting unit for a particular use.



⚠ CAUTION

- Do not expose the hoist to rain or water during use.
 - ※ It will cause rust generation and deteriorate insulation.
 - ※ To extend the life of the hoist installed outdoors, secure a shelter for covering it completely.
 - ※ The shelter should be so designed as to check the entry of rain water into the chain bucket.
- Be sure to inspect the hoisting unit daily and regularly.
- Do not operate the unit when the load chain has either of the following problems:
 - 1) twisted, tangled, or knotted chain
 - 2) cracked or elongated chain
 - 3) severely worn chain



- 4) chain which does not move smoothly on sheaves
- 5) chain which is not lubricated
- ※ Damages to the chain may cause falling of a suspended load.
- Do not conduct electric welding to a load while it is suspended by the electric chain hoist.

Fig. 41
Long life not expectable

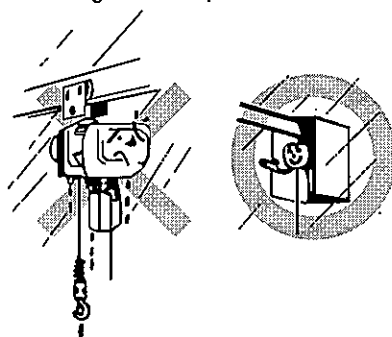

- ※ Electric current will flow through the chain, damaging the chain or even the hoist body.
- When the hoisting unit is used with cranes or handy lifts, or in ships, mines or petrochemical plants, observe relating laws and ordinances in your country.



- Lubricate the load chain before use.
Check for lubrication of the load chain regularly and apply oil as required (Fig. 42).
When the hoist is used in locations where it is often smeared and soiled with sand, dirt, iron powder and other foreign matters, use a liquid oil; where oil dripping should be avoided, use a grease. Select thus the most suitable lubricant according to a working site (Even a waste oil can be recycled if iron powder, dust, and other foreign matters are removed).

Fig. 42
Frequently lubricate the load chain for its full length

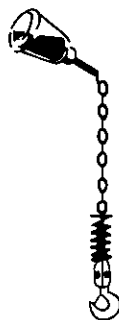

For use in coastal areas where rust is easily generated, various load chains with treatment are available.
Consult the dealer from whom you purchased the hoisting unit.
Even such specially treated load chains should be lubricated properly to secure a long life.
Proper lubrication will be sure to extend dozens of times the life of the chain.

VII) MAINTENANCE AND INSPECTION

1. General

To use the electric chain hoist safely, it is necessary to keep in a good condition not only the main body, but also other elements to which even higher force is imposed.
Voluntary inspection should be regularly made conforming to laws and ordinances

in your country. This section will list up items of inspection, though some may not be obligatory in your country. Inspection should also be made for support structures. A record of regular maintenance and inspection should include items required for securing the safety and dates of maintenance and inspection.

VIII) DAILY INSPECTION

- For daily operation, be sure to carry out the following check prior to operation.
- In cases of any abnormality, stop operating the hoisting unit and take proper counter-measure in accordance with the instruction of "Causes of Troubles & Trouble-shooting" before using it again.
- Consult a dealer of our products when it is not possible to take proper measures.
※ Do not make continuous running under abnormal condition as it is very dangerous and might lead to an accident.

1. Checking before operation

- ※ Check the following items before starting operation.
- 1-1 Carry out the following inspection by visual check.

Check point	Check items	 WARNING ! Checking criteria (Parts out of the following criteria should be replaced or disposed as waste.)
(1) Chain	1) Pitch elongation	No abnormal elongation should be found.
	2) Wear	Wire diameter should not extremely be worn out.
	3) Deformation	Free from deformation
	4) Flaws and other harmful defects	Free from cracks or other harmful defects
	5) Corrosion	Free from remarkable rust.
(2) Hook	1) Opening of hook	No remarkable deformation should be found.
	2) Deformation	Free from bend and twist.
	3) Flaws and other harmful defects	Free from cracks and other harmful defects.
	4) Movement	Bottom hook should rotate smoothly.
(3) Body	1) Bolts, nuts, screws, split pins, etc.	Bolts, nuts, screws, split pins, etc. seen from the outside should be in proper position and they should not be loose fit.
	2) Oiling & grease up	Check the necessity of adding oil, applying oil or oiling in specified places.
(4) Trolley	1) Bolts, nuts, screws, split pins etc.	Bolts, nuts, screws, split pins, etc. seen from the outside should be in proper position and they should not be loose fit.
	2) Oiling & grease up	Check the necessity of adding oil, applying oil or oiling in specified places.
(5) Push-button switch, cord	1) Appearance	There should be no deformation, breakage, loose of screw, etc.

(5) Push-button switch, cord	2) Switch operation	Marking should be shown clearly. Switches should operate correctly. Interlock should operate correctly.
(6) Power source connection	1) Negative phase connection	Connection should not be in reverse phase.
(7) Sling fixture	1) Wear, deformation, etc.	No abnormality is to be seen.

1-2 Make sure that there is no twist nor tangle on the load chain.

In the electric chain hoist, model with multiple load chains (FA and FB types with 2-ton and 3 ton capacity, as well as SA with 1 ton capacity), check and see if there is any abnormal condition called capsized bottom hook block where the bottom hook goes through in-between load chains. In such case, there exists a twist in the load chain which will reduce the load sustaining capacity of the chain and may also cause damage on the body and the chain even without load if it is wound up nearly to the upper limit position.

As it is a very dangerous condition, be sure to make correction before operation.

Fig. 43

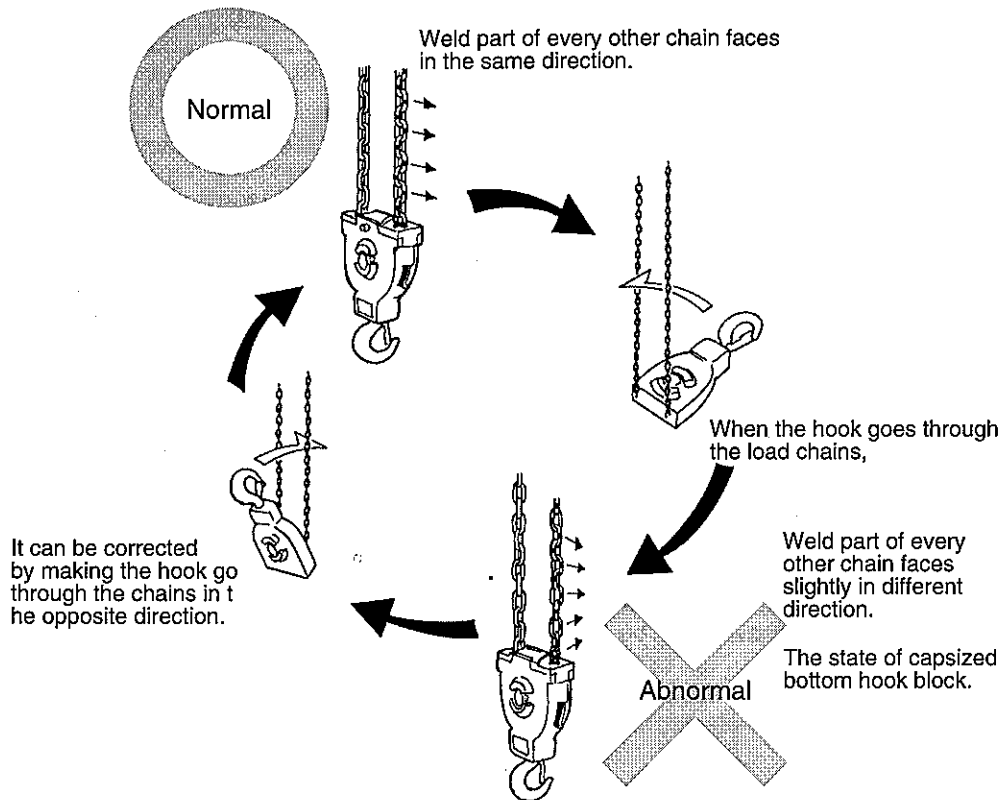

2. Checking by idle operation

- Does the bottom hook rotate smoothly? Does the safety latch function in perfect manner?
With regard to the hook provided with idle sheave, does it rotate smoothly?
- Check if there is any dent or deformation in the switch spring on the load side (The switch spring should be exchanged with new one, when its free length becomes shorter than the limit length for its exchange).
- Check the whole length of the load chain if there is oil shortage or twist of the chain.
- Check if there is any dent or deformation in the switch spring on the unload side (The switch spring should be exchanged with new one, when its free length becomes shorter than the limit length for its exchange).
- Isn't there dust or water left in the bucket? Is the chain bucket properly installed?
- Isn't there any foreign substances on the rail where wheels of trolley and crane saddle, etc. should run?
- When the push button switch of the electric chain hoist is manipulated, does it move in the direction as indicated on the push button switch? Does the over-lifting protection device work properly for upper and lower limits? (Try actual operation several times without load.)
- On releasing the push button switch, the hoisting unit should make immediate stop. Also check if there is any abnormal sound or odor. In doing this, check and see that moving of the chain is done properly with no abnormality.
- All the sling fixtures to be used on the day should be checked thoroughly for the existence of defects.

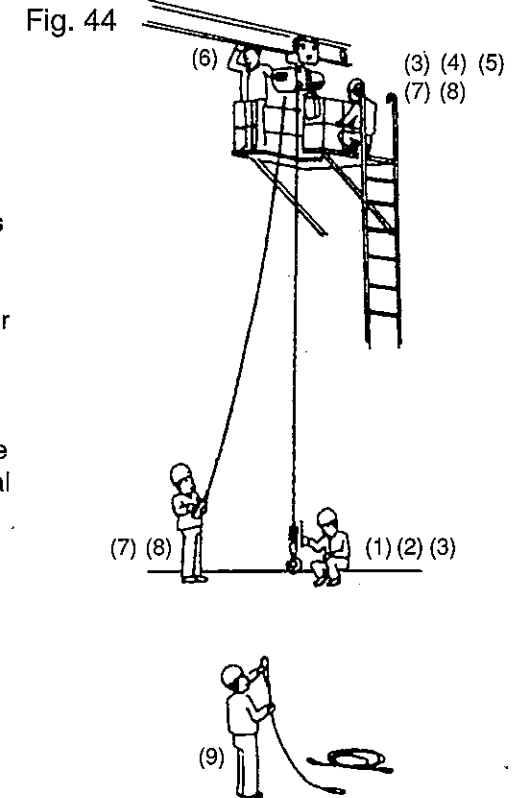

3. Checking by rated load operation

In the state of hoisting the rated load, stop the hoist halfway in un-winding the load and check the distance of movement after turning off the switch until stopping of the load.

- Normal distance to the stopping is within the length of one link.

IX) PERIODIC INSPECTION BY USER

Make it a rule to conduct a periodical voluntary inspection to ensure safe and full-functioned operation of the electric chain hoist.

- When parts replacement or adjustment work is done at the time of voluntary inspection, operate the electric chain hoist after confirming the instructions of "the Checking and Trial Operation After Installation". (page. 11)
Keep the file of the record of voluntary inspection for five years.
- Carry out the inspection after completely switching OFF the power source of the electric chain hoist and reconfirming the safety of the surrounding area.
※Be sure to start the inspection after the sign of "Under Inspection" is placed.
- It is recommended that a checking stand should be provided specially for the inspection.

1. Monthly inspection

- Carry out the voluntary inspection more than once in a month.
- If there is any abnormality discovered by the inspection, take appropriate measures against it.

In the monthly voluntary inspection, place more importance on the following items.

- (1) Do all the important functions of the electric chain hoist operate in normal way?
- (2) Is there degradation in any of the essential parts beyond the acceptable limit?
- (3) Is the overall power supply condition kept well? It is also important to check the looseness of respective clamping bolts and nuts for support structure and the electric chain hoist.

For checking of the electric chain hoist and its power feeding condition, carry out the inspection for all the items listed in the monthly inspection table. With regard to the support structure, check it by taking consideration of required check points for each type of the crane.

As for the inspection methods and measures, refer to "the Method of Maintenance and Inspection". (page. 18)

2. Annual inspection

If any abnormal points are found through the inspection, appropriate measures should be taken.

In the annual voluntary inspection, place more importance on the following items.

Test operation of the crane with the rated load should be done to check every performance of the electric chain hoist as well as the abnormality in respective parts of the support structure.

Make the instruction manual for the inspection and carry out the inspection and maintenance in accordance with it. As for the inspection methods and measures, refer to "Procedures for Maintenance and Inspection" stated below.

Carry out the monthly inspection once in every month or in shorter period, and the annual inspection once in every year or in shorter period.

Place an order for overhaul and inspection to our dealers.

3. Durability of elements and parts

WARNING

- Do not use parts and the electric chain hoist over the limit of use. In carrying out the monthly and annual voluntary inspection and the like, if any wearing parts are found in excess of the standard limit of use, they should be replaced for sure.
※It is very dangerous to use parts over the standard limit of use.



- Inspection methods for the limit of use are shown in " Procedures for Maintenance and Inspection " and in "Criteria for Using and Checking Electric Chain Hoist" (chapter XII, page. 26 ~ 28).

X) PROCEDURES FOR MAINTENANCE AND INSPECTION

WARNING

- Before doing maintenance, inspection and repair work, be sure to switch OFF the power source.
- Maintenance, inspection and repair work should be done by persons with specialized knowledge, or else, you should ask a dealer of our products.
- Make it a rule to carry out maintenance, inspection and repair in non loading (hoisting no load) condition.
- If any abnormality is found in the maintenance and inspection, do not use the hoist.



1. Before making inspection

Be sure to follow the proper inspection method to ensure safe and full-functioned operation of the electric chain hoist.

- Carry out the inspection after completely switching OFF the power source of the electric chain hoist and reconfirming the safety of the surrounding area.
- In case of making overhaul, be sure to put the electric chain hoist down on the ground.
- For replacement of spare parts, never use parts other than those specified by the manufacturer of the electric chain hoist.

Fig. 45

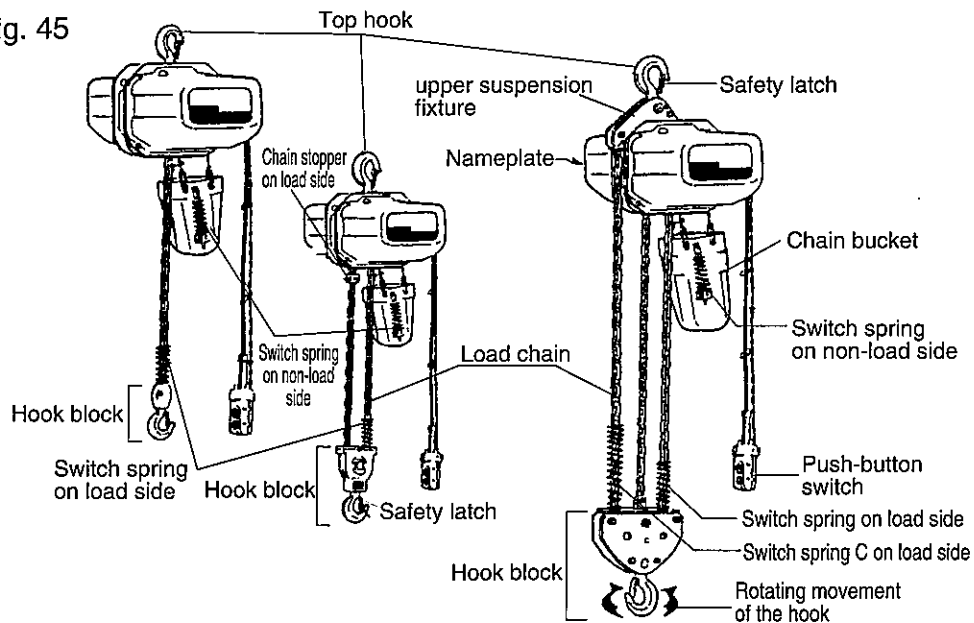

2. Checking the hook and its lifetime

Top hook and upper suspension fixture

- Does the latch function in normal way without any abnormality?
- Is there any remarkable flaw or deformation in the hook and others as can be identified by visual check?
- Does the idle wheel rotate smoothly or is it well engaged with the load chain?
- Is there looseness or missing of bolts, nuts and split pins?

Hook block

- Does the latch function in normal way without any abnormality?
- Does the hook rotate smoothly?
- Is there any remarkable flaw or deformation in hooks and others as can be identified by visual check?
- Is there looseness or missing of bolts, nuts and the like?
- In case of hoists with more than two load chains, does the idle wheel rotate smoothly?
- Isn't there a lot of foreign particles stuck on it?

Measurement of hook opening

The opening of hook becomes wider when the load much exceeding the rated load is hung or a heavy load is applied on the tip of it.

Hook with such widened opening does not keep the required strength nor shock absorbing power as specified, therefore, it should be replaced with new one.

Fig. 46

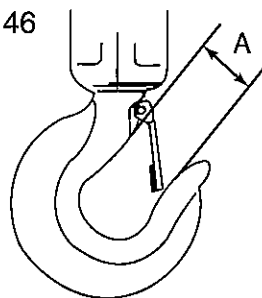

When the dimension shown by "A" in Fig. 46 has reached more than the limitation as specified in Table 6, the hook should be replaced with new one. It is very dangerous to use such hook with widened opening again after heating and remedy. Be sure to scrap it and replace it with new one.

Table 6 Guide for hook replacement

Rated load (t)	250kg	490kg • 0.5 t	0.9 t • 1 t	2 t	2.8 t • 3 t
Value A (mm) recommended by maker	30±1	26.5±1	31±1	38±1	45±1
Limit value A (mm)	33.0	29.2	34.1	41.8	49.5

Flaws, wear and bend of hook

Fig. 47 Hooks in the condition as shown in(1)-(3) also require replacement.

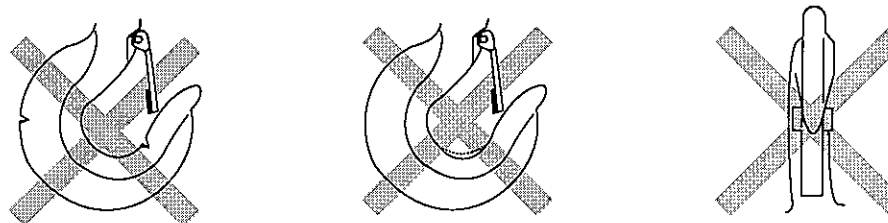

(1) Sharp flaw is visible.

(2) Wear: In accordance with Table 7.

(3) Turning (bend) is visually recognized.

Table 7

Wear Limitation of Contact Part in sling fixtures and support structure (Unit mm)

Rated load (t)	[H] dimension of new hook	Limitation of dimension	Rated load (t)	[H] dimension of new hook	Limitation of dimension
250kg	18	16.2	2 t	35	31.5
490kg • 0.5 t	19	17.1	2.8 t • 3 t	49	44.1
0.9 t • 1 t	25	22.5			

● Rotation and deformation of idle wheel (not provided in the type with single load chain)

When there is a lot of foreign particles stuck on the idle wheel, clean it up by overhaul. In doing it, check the following points.

1. Abnormality in bearing and rotation shaft of the idle wheel.
2. Accumulation of foreign particles and abnormal wear in the pocket part of the idle wheel.
3. Deformation in the projected part of the wheel (See Fig. 48).

When it is reassembled, be sure to apply grease-up in the rotating part. When the idle wheel is kept clean, check the deformation in the projected part of the wheel by visual check.

Fig. 48

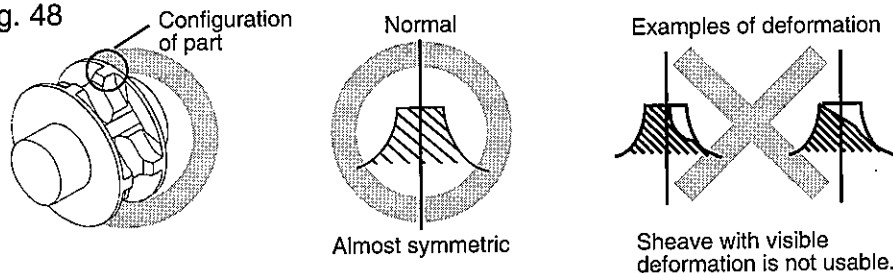

Bottom hook

● Thrust bearing

When the rotating movement of the hook is not smooth, or when the clearance shown in Fig. 50 is over 2 mm, it requires overhaul of the bottom hook for replacement of defective parts.

In some cases, thrust bearing can be separately replaced. Be careful in fitting it in not to take the upside down. The one with larger inner diameter is the lower side.

In Fig. 49, if there is visible deformation in the part pointed by the arrow [A], it should be replaced with new one.

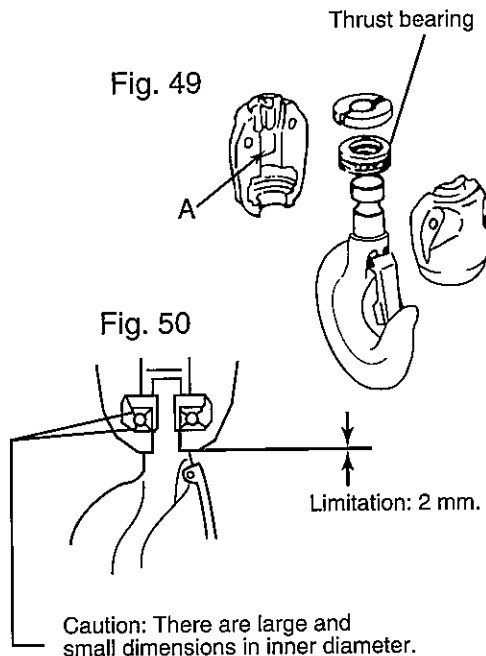

3. Checking the chains and their lifetime

- Is there sufficient oiling on the whole length?
- Are there any remarkable flaws?
- Is there any knot or twist?

Fig. 51

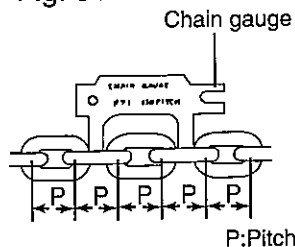
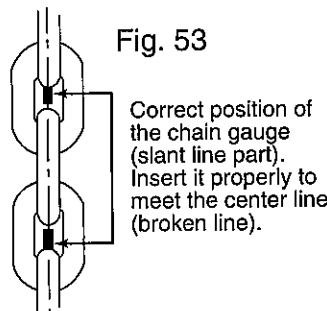

Fig. 52



Fig. 53



Measurement of pitch elongation by chain gauge

Check the load chain not partly but for the whole length in careful manner. Insert the chain gauge in every 50 cm (see Fig. 53) and check the elongation of the pitch.

If the pitch elongation is within the limitation for use, inserted part of the chain gauge will touch the load chain and it cannot go through links as shown in Fig. 51.

If the pitch gets larger than the limitation for use, the chain gauge will go through links as shown in Fig. 52.

When the pitch elongation is quite near to the limitation, make the interval of measurement shorter around such spot and check if there is any single point where the chain gauge goes through.

When there is even a single spot where the chain gauge goes through it, replace it with a new load chain.

Measurement of wire diameter reduction by chain gauge

When the wire diameter of the load chain becomes very small by the effect of rust or chemicals, etc., it is rather dangerous so it should be replaced with new one.

As it is shown in Fig. 54, if the opening of the chain gauge gets engaged with the chain when it is inserted, the wire diameter is less than the limitation for use. In such case, change the load chain with new one.

Fig. 54

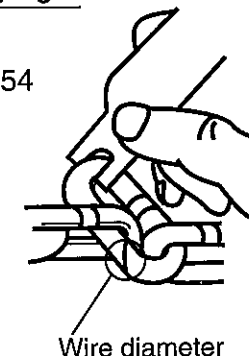

Other visual inspection of load chain

When some flaws or bends are found in the load chain, or when foreign particles are deposited on it, replace the load chain with new one. Even by a most disadvantageous measurement, if the wire diameter (see Table 8) has worn out more than 5%, scrap it as rejected.

If there are any other remarkable deformation of shape or track of heating effect that are clearly seen by visual check, it should also be replaced with new one.

Table 8 Normal wire diameter and pitch (unit: mm)

Chain hoist types	Normal wire diameter	Normal pitch
SA-0.25, SA-0.49, SA-0.5, SA-0.9W, SA-1W FA-0.49, FA-0.5, FB-0.49, FB-0.5	6,3	19
FA-0.9S, FA-1S, FA-2, FA-2.8, FA-3 FB-0.9S, FB-1S, FB-2, FB-2.8, FB-3	7,1	21

Precautions for replacement of the load chain

- In principle, the chain should not be changed by the user. Call a dealer of our products for it.
- Take special care about the following precautions for replacement of the load chain.

- Weld part of the vertical link should always be in the opposite side (outside) of the load chain wheel (Fig. 55).
- In the chain hoist with more than two load chains, the link to be fixed by the chain stop pin for prevention of twist of the load chain should be a vertical link.
- The load chain should be replaced as a whole unit. Do not change only a part of it to be connected with the old one.

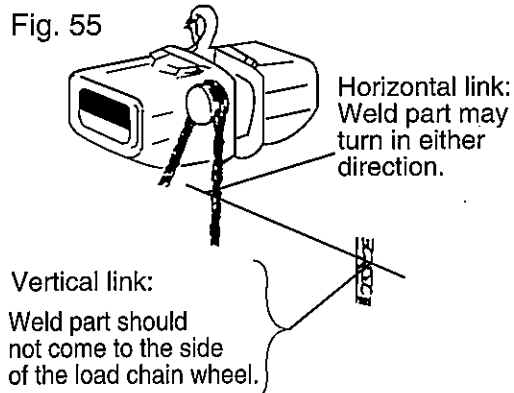

4. Checking the switch spring and its lifetime (both on load side and unload side)

Reduced free length of the switch spring

For Enabling the switch spring to fully function, it should be exchanged with new one when its free length becomes shorter than the limit value specified in Table 9.

Table 9 (Common to each type of FA, FB and SA chain hoists; The switch spring is classified into three groups, that is, A on the load side, B on the unload side and C on the sub load side at 3.1 ton or 5 ton)

Lifting capacity(t)	250 kg ~ 1 t		2 t		2.8 t ~ 3 t		
	A	B×2	A	B×2	A	B×2	C
Switch spring	A	B×2	A	B×2	A	B×2	C
Dimension(L) of new spring	120	70	150	70	150	70	210
Dimension(L) of worn spring (to be exchanged)	108	63	135	63	135	63	195

Bent switch spring

- A bent switch spring should be exchanged with new one.
- A switch spring which is apt to be caught by the load chain and cannot freely fall down to the hook block should be exchanged with new one.

Fig. 56

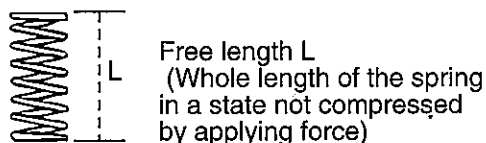
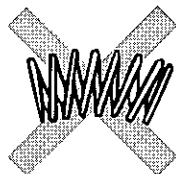

Fig. 57



5. Checking the chain bucket and its lifetime

When the following conditions are seen, do not continue to use it. Change it with new one.

- In the case of having damage on the chain bucket.
 - ※ It might cause a danger of dropping the load chain.
- When the lifting lug, etc. of the chain bucket is not fitted properly.
- In the case of having dust or water left in the chain bucket.
- The switch spring on the no-load side is yielded or bent. (Measure the free length of spring.)

6. Checking the chain stop bolt and its lifetime

Check the following conditions. In the case of unacceptable condition, do not continue to use it. Replace it with new one.

(This is exclusively for the hoist with double or triple load chains.)

- In case of double load chains, the end of the load chain on the load side is fixed by the chain stop bolt at lower part of the body, and in case of triple load chains, at hook block.
 - Pull out the chain stop bolt and check the deformation. At the time of pulling out the bolt, if it is not done in a secured condition to fully sustain the heavy weight of the hook block and the load chain, it might cause dropping of the chain or the hook block. It requires special care.
 - It will be easier to do this work, when using double load chains (see Fig. 58), after lifting up the hook block nearly to the upper limit, or when using triple load chains, with keeping the bottom hook block stabilized to the ground.
 - When the chain stop bolt is bent, or when there is visible, obvious deformation in a spot in contact with the load chain, it should be replaced with new one (See Fig. 59).
 - In fitting the chain stop bolt to the load chain, strict caution should be taken not to have the load chain to twist.
- Also, in the reuse of bolt which has passed the inspection, set it properly so that the same portion as before will get in contact with the load chain.

Fig. 58

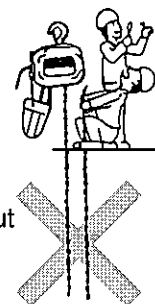

It is not only heavy but also makes it difficult to check the twist of the load chain.

Fig. 59

Unacceptable for use.

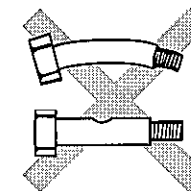

7. Checking the chain stopper

Check the following conditions. In the case of any unacceptable condition, do not continue to use it. Replace it with new one.

Monthly check and see if the bolt with hexagon socket head used for the chain stopper is not loose.

The chain stopper on the unload side should be attached to the third link counting from the end of the unload side of the load chain (Fig. 60).

Fig. 60

The third link from the end, on non loading side.

Fasten it sufficiently by using a wrench.

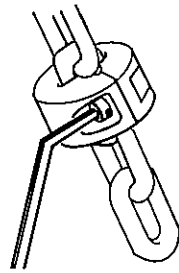

8. Checking the push-button switch

Check the following conditions. In the case of unacceptable condition, do not continue to use it. Replace it with new one.

- In case of having cracks or fracture in the switch casing.
- In case of failure in smooth movement of the push buttons (When the pressed button is released, it will not come up smoothly).
- After removing the cover, looseness of screws or abnormality in the lead wire is discovered.
- In case of having much of foreign particles stuck on it.

9. Inspecting the trolley and its lifetime

Check the following conditions. In the case of unacceptable condition, do not continue to use it. Replace it with new one.

Bend of side-plates

- Two side-plates should be free from deformation.
- The angle shown in Fig. 61 should be right angle.
- Supply oil if there is abnormal sound caused by lack of oil in making traverse movement.
- There should be no missing or looseness of the bolts, nuts, etc.
- The wheel with gear cut on it should not have dust in the geared portion.

Fig. 61

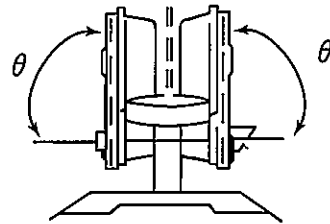

Wear of trolley wheels

Trolley wheel as described below should be replaced with new one.

Fig. 62

There is such a visible, obvious gap in the part which is in contact with the edge of I-beam.

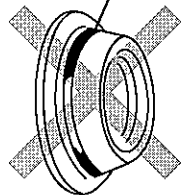

The wheel gets more than 5% wear-out from the original configuration.

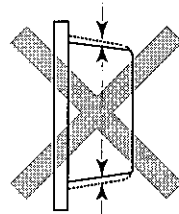

The wheel having partial deformation on the surface (visible degree).

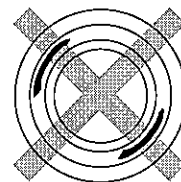

Wear of side-rollers

(applicable to the electric trolley, type MT-III)

- The portion of the side-roller contacting the bottom flange of the I-beam will be gradually worn out.
- Such a side-roller as shows wear exceeding 1 mm should be replaced.
- Such a side-roller as cannot smoothly revolve due to getting rusty and/or sticking foreign matters should be dismantled and cleaned.
- Take out the two hexagonal bolts shown in Fig. 63 and remove the rollers together with the mount to clean them with kerosine etc.
- ※ When replacing parts or assembling the unit after cleaning, be careful not to mix up the side-roller on the geared wheel with one on the plain wheel. The side-rollers should be fully oiled to guarantee their smooth revolution.

Fig. 63

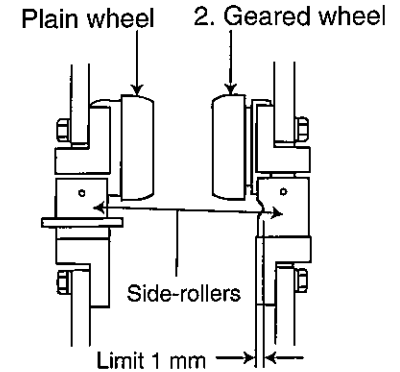

10. Checking the motor brake and its lifetime

When carrying out inspection of the motor brake, be sure to observe the following instructions for the sake of safety.

- (1) Put the electric chain hoist in the non loading state (the state of hanging no load on the bottom hook).
- (2) Lower the electric chain hoist down to about 10 cm before the point to actuate the safety against over-lowering in the lower limit.
- (3) Switch OFF the power source.

Fig. 64

When using double linings, pay attention to the direction of the notches. Do not fail to face them in the right opposite direction.

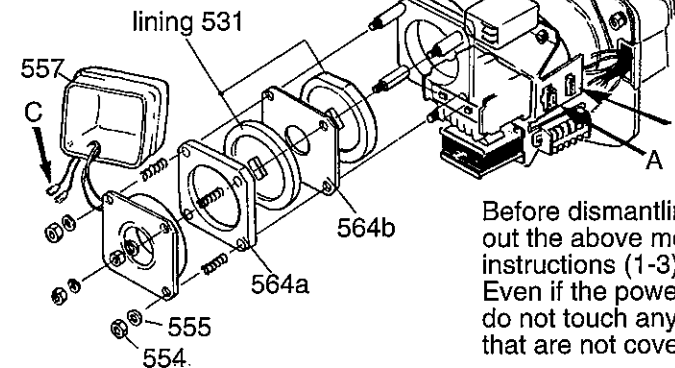
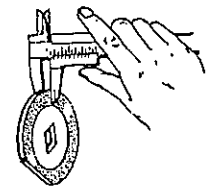

Fig. 65



Thickness limit: 7.5 mm

Before dismantling never forget to carry out the above mentioned important instructions (1-3). Even if the power source is OFF, do not touch any live points that are not covered.

- Thickness of the lining 531

The limit thickness of the lining 531 is 7.5 mm. It should be exchanged with new one, when its thickness is found to be less than the limit by the measurement shown in Fig. 65 (initial thickness: 8 mm).

- Some types of brakes have a single lining and therefore have not a thin moving core 564b.

- If the assembling sequence of the thick moving core 564a and the thin moving core 564b is not correct, the brake would function incorrectly. Be sure to mount

How to dismantle the brake(refer also to the exploded view of the body)

- (1) Remove connectors to point A and B (see Fig. 64).
- (2) Remove a case for electrical equipment 361.
- (3) Pull out the covered terminal shown in Fig. 64 C (it is not a problem if the connection would be changed each other in reassembling).
- (4) Remove brake cover 557 and then remove 554 and 555 so that it could be dismantled as shown in Fig. 64. In order to reassemble it, carry out the dismantling instructions in reverse order. After dismantling and assembling for this brake test never fail to make sure if the brake functions correctly with the rated load.

11. Adjustment and disassembly of the overload-limiter of FAⅢ, FBⅢ and SAⅢ-type electric chain hoists

Structure

- (1) It is a rotor-slip type: the rotor and its shaft slip when overloaded.
- (2) When the load cannot be lifted up because of overloading, release the pushbutton immediately. Otherwise it will cause the motor to be burnt and the linings of the slip mechanism to be heat and worn.
- (3) Repeated rotor slippings will damage the hoist and make it unable to lift the rated load. Then adjusting the rotor slip mechanism or replacing the parts will be required.

How to adjust the overload-limiter

- (1) Unload and make the bottom hook of the hoist free from any weight.
- (2) Put off the power source.
- (3) Remove the motor cover.
- (4) See inside through each of the four holes of the motor bracket, to find that one blade of the lock-washer is folded on a concave of the adjustment nut. (It is to prevent loosening of the nut.)
- (5) Unfold the blade with a screwdriver. (Fig. 66)
- (6) Then the adjustment nut can rotate. Rotate it with a screwdriver to adjust the slip. When it is rotated clockwise, the lifting capacity will increase.
- (7) In case that the rated load cannot be lifted up, rotate the nut clockwise by 2 or 3 pitches to bring the hoist back to the former overload-preventing state.

- (8) In case that only half of the rated load can be lifted up, rotate the nut by further 2 or 3 pitches.
- (9) Put on the power source. And do tests with some different loads for adjustment. In case that the adjustment nut is rotated clockwise too far, the slip mechanism is tightened too much, and as a result, excessive overloading will be always possible, as is quite dangerous.
- (10) The hoist should be set to work with a load 125-150% of the rated load.
- (11) After the adjustment is made, try to find a point where the blade of the lockwasher meets a concave of the nut adjustment, and fold the blade so that the nut will not rotate. (To do this job, be sure to put off the power source.)
- (12) After making sure that the adjustment nut is locked with the lock-washer, attach the motor cover.

How to disassemble the overload-limiter

- (1) Unload and make the bottom hook of the hoist free from any weight. Put off the power source and then take off the motor cover (same as the adjusting procedure).
- (2) Loosen the motor setting hexagonal cap nut to remove the motor bracket, and pull out the rotor set.
- (3) Unfold the folded blade of the lock-washer. Rotate the adjustment nut anticlockwise to remove it. Pull out from the rotor the lock-washer, coned disc spring, disc hub, anti-rotation pin, and the motor shaft in the said order.
- (4) Clean those parts. Replace parts if damaged or worn.
Note: In case linings are replaced, the rotor must be replaced together. Replacement of linings only is not possible since they are specially processed.
- (5) After checking all parts, assemble them in the order opposite to disassembling.
- (6) In the process of assembling, be careful not to stain the lining sides of the disc hub and the linings with oil or grease. As to the number of coned disc springs, refer to table (10).
- (7) Tighten the adjustment nut by hand, put the rotor set into the motor, attach the motor bracket, and make adjustment.
- (8) As to the way of adjustment, refer to the points (1)-(12) of adjusting procedure.

Fig. 66

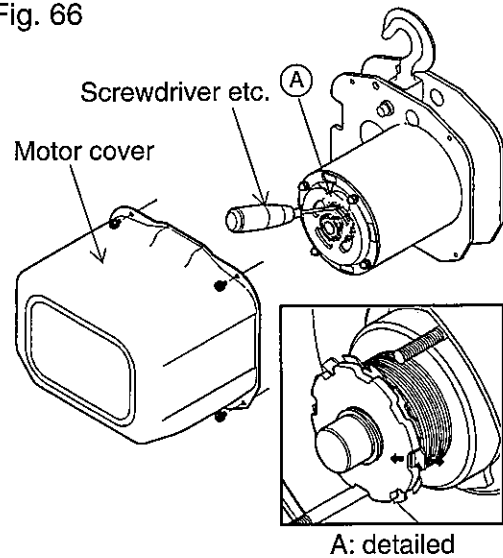

Fig. 67

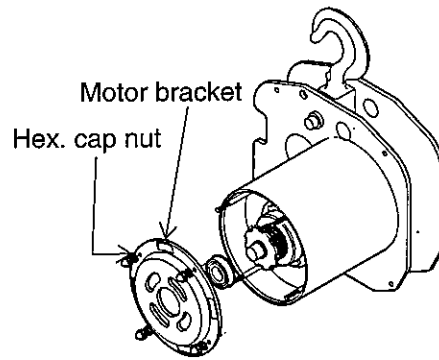

Fig. 68

Structure of the coned disc spring

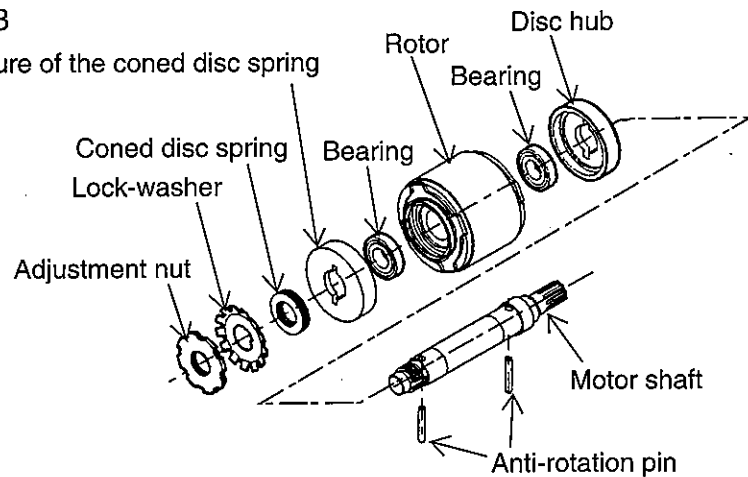
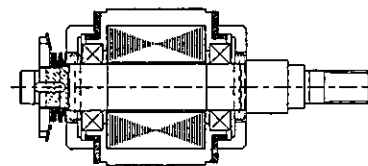

Table 10
Specification of the coned disc spring

	Dimensions	Number	Combination
250kg 490kg 0.5 t	31.7×20.4×0.4	10	
0.9 t 1t , 2t 2.8 t 3t , 5t	41.6×25.5×0.5	10	

● For structure of the coned disc springs



12. Checking the nameplate and tags

- Do not remove the nameplate, labels for cautions and tags.
- Is it easy to clearly read the indication on the nameplates and tags? Do not leave stain or dirt on them but always keep them clean.
- The following three items are important when placing orders for parts. Keep the note of them and be sure to give them together with parts designation and numbers (or assembly numbers) shown in the exploded view, when placing order for the parts.
 - (1) Type and model
 - (2) Rated load
 - (3) Fabrication number (Serial number)

13. Wiring inside the body and fixing of the parts

Check if the wiring inside the body is not damaged or terminals and connectors are not loose. Furthermore, check if clamping bolts for each part are not loose.
※Firmly tighten loose parts and bolts.

14. Inspection of general functions and durability

When the inspection of each element as mentioned above is completed, conduct trial operation specified in the section V-5 (page 11) "Checking after the installation and trial operation".

- Check that the electric chain hoist moves according to directions from the pushbutton switch.
- Make sure a distance the hook travels until it stops, having released the pushbutton.
- Check that the over-lifting/lowering protection device functions properly for upper and lower limits.
- Check that any abnormal sound is not caused in vertical and traversing movement or traveling of the electric chain hoist.

XI) TROUBLE-SHOOTING

Causes for general troubles on the electric chain hoist are listed up in the following table. Consult a dealer of our products in case that other troubles than those indicated in the table.

Table 9 List for trouble-shooting

Abnormality or troubles	Possible causes	Counter-measures	Remark
1. Motor does not run.	● Master switch on the switch cabinet is turned off. Fuses are burnt out. Breaker is actuated.	Check the switch cabinet and turn on the master switch.	
	● Improper connection of power supply line	Properly make connection of R-S-T lines of power source.	Models for 3- phase
	● Power source is connected to the reverse phase.	Make change of R-T lines of power source	Models for 3- phase, equipped with negative-phase protector

	<ul style="list-style-type: none"> ● Damaged transformer. Improper connection of push-buttons, electro-magnetic relays and limit switches. Broken inside wiring, cords and cables. 	Check for continuity and make repair of damaged devices and parts. Replace damaged parts with new ones.	
	<ul style="list-style-type: none"> ● Brake cannot be released. 	Secure connection of brake. Replace a damaged brake plate.	FA • FB • SA models
	<ul style="list-style-type: none"> ● Wrong power source 	Use correct power source as per nameplate.	
	<ul style="list-style-type: none"> ● Big voltage drop 	Secure supply voltage as specified and use a suitable power cable.	Smaller power cable may cause a sudden voltage drop on starting.
	<ul style="list-style-type: none"> ● Extremely overloaded 	Apply a load only up to the rated load.	
2. The unit exhibits other movements than those directed by the push-buttons.	<ul style="list-style-type: none"> ● Inside wiring like push-buttons and electro-magnetic relays etc. are not correct. 	Make proper connection as per connecting diagram.	
	<ul style="list-style-type: none"> ● Malfunction of directional switches 	Check for connection.	Models for single phase
	<ul style="list-style-type: none"> ● Incorrect connection of motor starting coils 	Make change of starting coil terminals.	Models for single phase
3. Lifting impossible	<ul style="list-style-type: none"> ● Extremely overloaded 	Apply a load only up to the rated load.	
	<ul style="list-style-type: none"> ● Improper connection of push-buttons, electro-magnetic relays and limit switches. Loose inside wiring. 	Check for continuity and replace damaged parts with new ones. Secure connection.	
4. Lowering impossible	<ul style="list-style-type: none"> ● Improper connection of push-buttons, electro-magnetic relays and limit switches. Loose inside wiring. 	Check for continuity and replace damaged parts with new one. Secure connection.	
5. Brake does not function.	<ul style="list-style-type: none"> ● Big voltage drop of power source 	Secure voltage as specified.	
	<ul style="list-style-type: none"> ● Brake gap exceeds the limit. 	Replace worn parts with new one.	
	<ul style="list-style-type: none"> ● Terminals are disconnected. ● Solenoid coil burnt out. 	Replace the brake coil with new one.	
	<ul style="list-style-type: none"> ● Damaged rectifier 	Replace the printed board with new one.	
	<ul style="list-style-type: none"> ● Incorrect connection of printed boards. 	Make correct connection according to marking of the boards.	



6. Reversing operation impossible	<ul style="list-style-type: none"> ● Damaged governor switch 	Replace it with new one.	Models for single phase SA
7. Over-coasting on stopping the lifting/lowering work	<ul style="list-style-type: none"> ● Brake gap reaches nearly limit. ● Over-loaded 	Replace worn parts with new one. Apply a load only up to the rated load.	
8. Slow working speed	<ul style="list-style-type: none"> ● Over-loaded ● Voltage drop of power source 	Apply a load only up to the rated load. Secure voltage as specified.	see point 1
9. Over-heated motor	<ul style="list-style-type: none"> ● Over-loaded ● Voltage drop of power source ● Extremely high atmospheric temperature ● Brake gap reaches nearly limit(solenoid starting impossible). 	Apply a load only up to the rated load. Apply a load only up to the rated load. Keep the surrounding temperature under 40 °C by preventing radiant heat, etc. Replace worn parts with new one.	see point 1
10. Motor does not stop on reaching the upper and lower limits of the electric chain hoist.	<ul style="list-style-type: none"> ● Limit switches do not function. 	Check for connection. Correct the connection if wrong. Check limit switches for their reaction with contacts and replace them with new one if disordered.	
11. Abnormal sound	<ul style="list-style-type: none"> ● Extremely worn gears ● Extremely worn chains, sprockets and guides. 	Replacement of parts Replacement of parts	
12. Rapid wear of chains, compared with those fitted to other electric chain hoists	<ul style="list-style-type: none"> ● Insufficient or no lubrication. ● Worn sprockets or sprocket guides. ● Over-loaded. 	Properly lubricate as specified. Replace them with new one. Apply a load only up to the rated load.	
13. Chains do not well engage with sprockets.	<ul style="list-style-type: none"> ● Unsuitable chains ● Extremely worn chains, sprockets and guides. 	Replace them with correct chains. Replace them with new one.	When replacing chains with new one, check also sprocket and guide for their worn state.
14. When contacting the electric chain hoist, a shock is given.	<ul style="list-style-type: none"> ● Wrong grounding ● Electrical components like push-buttons are not properly insulated. 	Firmly connect the earth line to the earth. Firmly connect the travel rail to the earth. Keep the rail face contacting the wheels free from paint, etc. Make repair of disordered points and replace damaged parts with new one.	Models equipped with electric trolley

XII) CRITERIA FOR USING AND CHECKING ELECTRIC CHAIN HOISTS (BASED ON JIS B 8815)

The following criteria are prepared with reference to "the Safety Rules for Electric Chain Hoists(JIS B8815). Strictly observe them in using the electric chain hoist.

WARNING (1. Criteria for use)



The following shall be observed in using the electric chain hoist.

- (1) Make sure that the type, class and range of lift of the electric chain hoist, etc. are fit for conditions of its use. 
- (2) The electric chain hoist should be used only at the rated voltage and frequency. Consult us in case that a power generator is used directly as power source.
- (3) The electric chain hoist should be used under its perfectly grounded condition to avoid electric shock.
- (4) The electric chain hoist should be daily checked before use, and be inspected periodically at given intervals.
- (5) The electric chain hoist should not be modified without our approval. If any modification is necessary, it should be done by us.
- (6) The electric chain hoist should be hung on beams and the like having sufficient strength. In the case of trolley type hoists, they should be hung on traverse rails (for example, H-shaped or I-shaped steels) having sufficient and accuracy.
- (7) Before using the electric chain hoist, check whether or not the load chain is passed in a loop around the idle wheel with the bottom hook, or twisted or kinked, and use after correcting these irregular forms.
- (8) Use load chains lubricated.
- (9) When the electric chain hoist is used in special conditions such as lower or higher temperatures, or corrosive atmosphere, etc., consult us before use.
- (10) Use the electric chain hoist, applying lubricants at appropriate intervals to its gears, bearings and points which are liable to wear.
- (11) When the electric chain hoist is used outdoors, provide a cover to prevent water and rain.
- (12) Load chains other than those specified by us should not be mounted to the electric chain hoist. 
- (13) The electric chain hoist should not be used with loads higher than the rated load, and not be used under such conditions as giving impulsive force to it.
- (14) In inverse turn from lifting to lowering and vice versa, etc., stop once movement and then carry out next operation. Plugging operation (sudden reverse turn) should be avoided.
- (15) Avoid such an operation as to often use the over-lifting/lowering protection device.
- (16) Avoid to pull a load in oblique direction.
- (17) Avoid an operation to heavily swing a load.

- (18) Don't pull the push-button switch cord to traverse a load suspended (horizontal pulling).
- (19) Don't fall the electric chain hoist from higher positions.
- (20) Don't make electric welding of a load in suspension by the electric chain hoist.
- (21) Avoid frequent inching operation.
- (22) Avoid such an operation as to apply a sudden force to load chains.
- (23) Don't wind load chains directly around a load.
- (24) Don't hang a load on the tip of the hook.
- (25) Avoid an operation of so-called earth lifting.
- (26) Don't leave the electric chain hoist for many hours with a load suspended.
- (27) Pay attention that any persons or their hands or legs are not right underneath a load suspended.

CAUTION (1. Criteria for checking)

The following shall be observed in using the electric chain hoist.

- (1) In case of 3-phase induction motor, it should not be operated in single phase. 
- (2) Don't press the emergency stop button in a normal condition (option).
- (3) When the electric chain hoist is installed for the first time, make sure that the power lines are not connected in the reverse phase. 
- (4) To avoid a voltage drop of the electric chain hoist, it is recommendable to use power cables with bigger size.
- (5) When the electric chain hoist will not be used for a long time, turn off the power source and keep it after rust preventive treatment in places where it is not subject to rain water and sea breeze.
- (6) When the electric chain hoist is used with cranes, as simplified lifting devices, or in ships, mines or petrochemical plants, especial care should be taken to relevant laws and regulations.

2. Criteria for check

- (1) Use the electric chain hoist by checking it daily ⁽¹⁾periodically⁽²⁾.
- (2) Refer to Table 8⁽³⁾ which gives check items, check methods and check criteria to be used in the daily check. However, items other than those specified should be also checked, when the electric chain hoist is frequently used, or in special cases.
- (3) Repair or replacement of parts should be carried out by those persons who are familiar with the function of the electric chain hoist, or ask a dealer of our products.
- (4) When the electric chain hoist is repaired, check it on periodic check items given in Table 8⁽³⁾ after its repair, and make sure that it works in a normal state.
- (5) Don't use the electric chain hoist which has reached the limits of total allowable running hours.

Notes (1) Refer to checking before use.

(2) Periodic check is usually made at intervals of one month, three months, six months or one year depending on the frequency of use, and consult us about the periodic check which can be also made in our factory.

(3) Check the items with the mark "O" in Table 8⁽³⁾.

Remark:

When a hoist is considered to be capable of being further use, while it has already reached the limits of allowable running hours, it may be used, having deliberated on its use with us.

Table 8 Criteria for check

Type of check		Check items	Check method	⚠ WARNING ! Check criteria (devices and parts out of the following criteria should be replaced or disposed as waste.)
Daily check	Periodic check			
<input type="radio"/>	<input type="radio"/>	Marking (nameplates, labels)	Visual	Presence of marking. Replace them if unreadable.
Load chain				
	<input type="radio"/>	Type	Visual	Confirm the type of load chain
<input type="radio"/>	<input type="radio"/>	Pitch elongation	Check visually in daily check and by measurement in periodic check.	Don't use load chains with pitch elongation of 3% minimum (Prepare a list of standard dimensions before use.)
<input type="radio"/>	<input type="radio"/>	Wear	Check visually in daily check and by measurement in periodic check.	Don't use load chains which are worn in diameter by 5% or more.
<input type="radio"/>	<input type="radio"/>	Deformation	Visual	Free from deformation.
<input type="radio"/>	<input type="radio"/>	Flaws and other harmful defects	Visual	Free from cracks and other harmful defects
<input type="radio"/>	<input type="radio"/>	Corrosion	Visual	Free from serious rust.
Hooks				
<input type="radio"/>	<input type="radio"/>	Opening of hook	Check visually in daily check and by measurement in periodic check.	No deformation should be found when its dimensions are compared with standard dimensions(A list of major dimensions of hooks should be prepared before their use.)
<input type="radio"/>	<input type="radio"/>	Deformation	Visual	Free from bend and distortion.
<input type="radio"/>	<input type="radio"/>	Latch	Visual	Free from severe wear or deformation and operates properly.
<input type="radio"/>	<input type="radio"/>	Deformation of shank	Check visually in daily check and by measurement in periodic check.	There should be no big clearance between hook and shank.
<input type="radio"/>	<input type="radio"/>	Swiveling	Visual	It can swivel smoothly and horizontally through 360 degrees.
<input type="radio"/>	<input type="radio"/>	Wear and corrosion	Visual	Free from severe wear and corrosion.
<input type="radio"/>	<input type="radio"/>	Flaws and other harmful defects	Visual ⁽⁴⁾	Free from cracks and other harmful defects
Body				
<input type="radio"/>	<input type="radio"/>	Frame	Visual	Free from deformation and severe corrosion.
<input type="radio"/>	<input type="radio"/>	Gear case	Visual	Free from severe deformation and corrosion.
<input type="radio"/>	<input type="radio"/>	Nuts, rivets, split pins, snap rings, etc. at all the components	Visual	In daily check, the presence of nuts, rivets, split pins, etc. which can be seen from outside should be checked, and nuts, rivets, snap rings, etc. should not get loose. In periodic check, abnormality of the said parts should be checked internally and externally of the said parts
	<input type="radio"/>	Gears	After dismantling check them visually or by measurement.	Free from abnormal noise, wear and breakage.

	<input type="radio"/>	Load sheave and idle sheave	After dismantling check them visually or by measurement.	Free from severe wear, deformation, flaws and breakage.
	<input type="radio"/>	Chain guide	Visually or by measurement	Free from severe wear, deformation and breakage.
	<input type="radio"/>	Limit lever	Visual	Free from severe wear, deformation and breakage, and operates smoothly.
	<input type="radio"/>	Bearings	Visually or by measurement	Free from harmful defects such as wear, flaws, breakage, etc.
<input type="radio"/>	<input type="radio"/>	Lubrication and greasing up	Visually and by measurement	Lubrication to the specified points and replenishment. (Change of gear-case oil if contaminated.)
Brakes and the like				
	<input type="radio"/>	Brake linings, brake discs and brake shoes	Visually and by measurement	Free from severe wear or local wear. Free from flaws and breakage.
	<input type="radio"/>	Brake screw (in mechanical braking device)	Visually or by measurement	Free from severe wear, deformation, flaws and breakage.
	<input type="radio"/>	pawl and ratchet wheel (in mechanical braking device)	Visually or by measurement	Free from severe wear, deformation, flaws and breakage.
	<input type="radio"/>	Brake spring (in electro-magnetic braking device)	Visually or by measurement	Free from severe wear, deformation, flaws and breakage.
	<input type="radio"/>	Oil seals and water-proof seals	Visual	Free from severe deformation and breakage.
	<input type="radio"/>	Chain buckets	Visual	It should be securely mounted on the hoist body and free from severe wear, deformation and breakage.
Motors and the Like				
	<input type="radio"/>	Motors (3 phase) (Single phase magnet-motors)	Visually and by measurement	It should not be over-heated and be sufficiently insulated. (Brush and commutator should not be severely worn.
	<input type="radio"/>	Electrical instrument (electro-magnetic contactors, relays, transformers, wiring, etc.	Visually and by manipulation	They should not be over-heated, be sufficiently insulated and operate smoothly. Wiring is secured, and all contacts of electrical instrument are in good order.
Traversing equipment (incl. Traveling equipment)				
	<input type="radio"/>	Traversing equipment	Visually and by measurement	There should be no abnormality in the combination of traversing equipment with the hoist body and in gears, brakes, wheels, hand chains, etc.
<input type="radio"/>	<input type="radio"/>	Nuts, rivets, split pins, snap rings, etc. in the equipment	Visual	In daily check, the presence of nuts, rivets, split pins, etc. which can be seen from outside should be checked, and nuts, rivets, snap rings, etc. should not get loose. In periodic check, abnormality of the said parts should be checked internally and externally.
<input type="radio"/>	<input type="radio"/>	Lubrication and greasing up	Visually and by measurement	Lubrication to the specified points and replenishment.

Push-button switches and Cords				
○	○	Appearance (marking, labels)	Visual	There should be no deformation, breakage, loose screws and the like. Marking should be clear and be exchanged with new one if unreadable.
○	○	Switch manipulation	By manipulation	Switches and an interlock system function properly.
○	○	Grounding	By measurement	Perfectly grounded
○	○	Reverse phase	By operation	Connection should not be in reverse phase.
Function and Performance				
○	○	Lifting and lowering function	Lift and lower without load (at rated voltage and rated frequency).	Load chains should be smoothly wound or unwound in lifting and lowering operation. For hoists with mechanical braking system, sound of the ratchet should be heard in lifting operation. There should be no abnormality in the braking system in lowering operation.
○	○	Traversing function	Carry out traversing without load.	Hoists should be smoothly traversed and should stop immediately after the operation is discontinued.
○	○	Starting	Visual	Hoists should be smoothly lifted, lowered or traversed at 90 % of the rated voltage.
○	○	Speed	Visually and by measurement	The lifting and traversing speeds at the rated load should be within indicated values.
○	○	Braking	Check visually in daily check and by measurement in periodic check.	The brake should securely function and a fall distance, having cut off the motor, should be less than 1% of the lifting amount in one minute.
○	○	Protection against over-lifting (friction clutch)	Operate without over-load to carry out over-lifting or over-lowering.	The protection device against over-lifting should properly function. (Make sure that the friction clutch is actuated, while the motor runs at idle.)
Load				
○	○	Loading	Carry out lifting, lowering or traversing at the rated load.	When hoists are operated at the rated load, rated voltage and rated frequency, there should be no abnormality in every part.
○	○	Load limiter	Lifting under overload conditions	The limiter should come to action at the preset value.
○	○	Others	Visually or by measurement	There should not be any other harmful defects in use of the unit.

Note (4): In periodic check, the magnetic particle test prescribed in JIS G0565 or the liquid penetrant test in JIS Z2343 should be carried out when necessary.

XIII) WIRING DIAGRAM

FA:Type

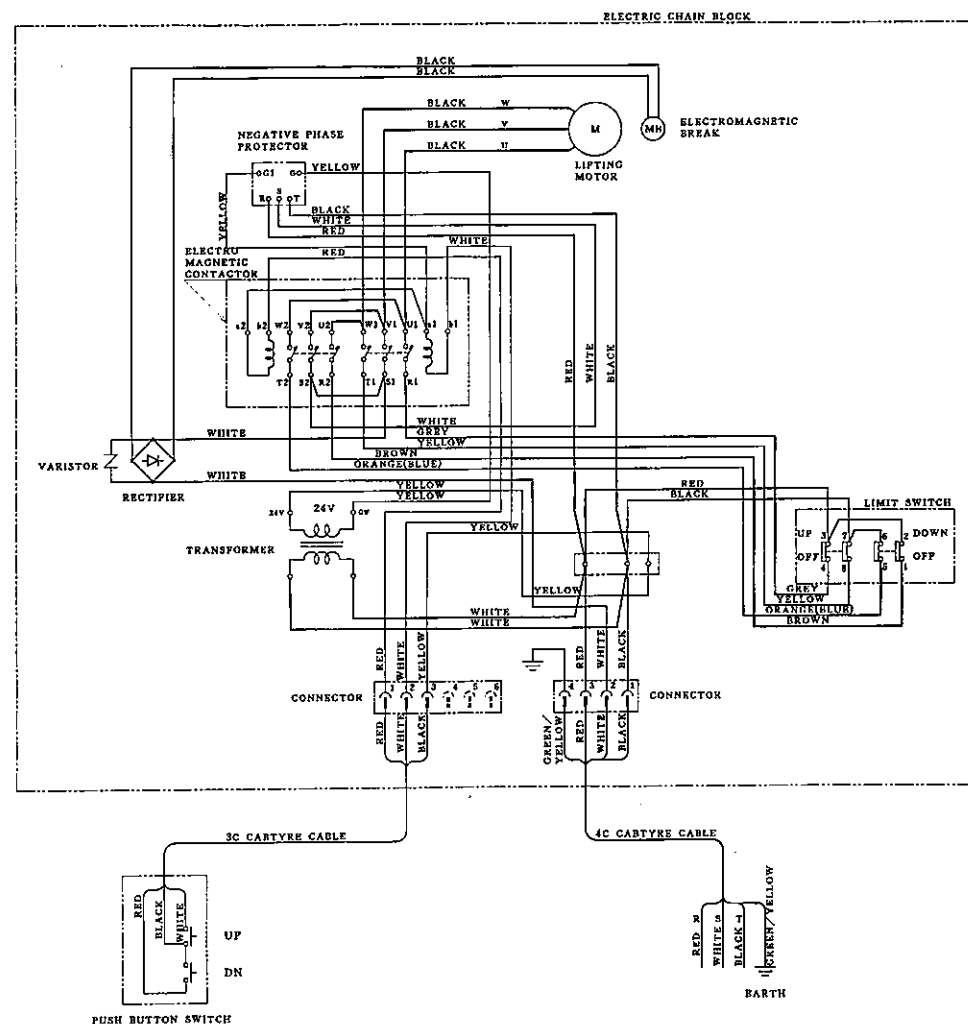

FB:Type

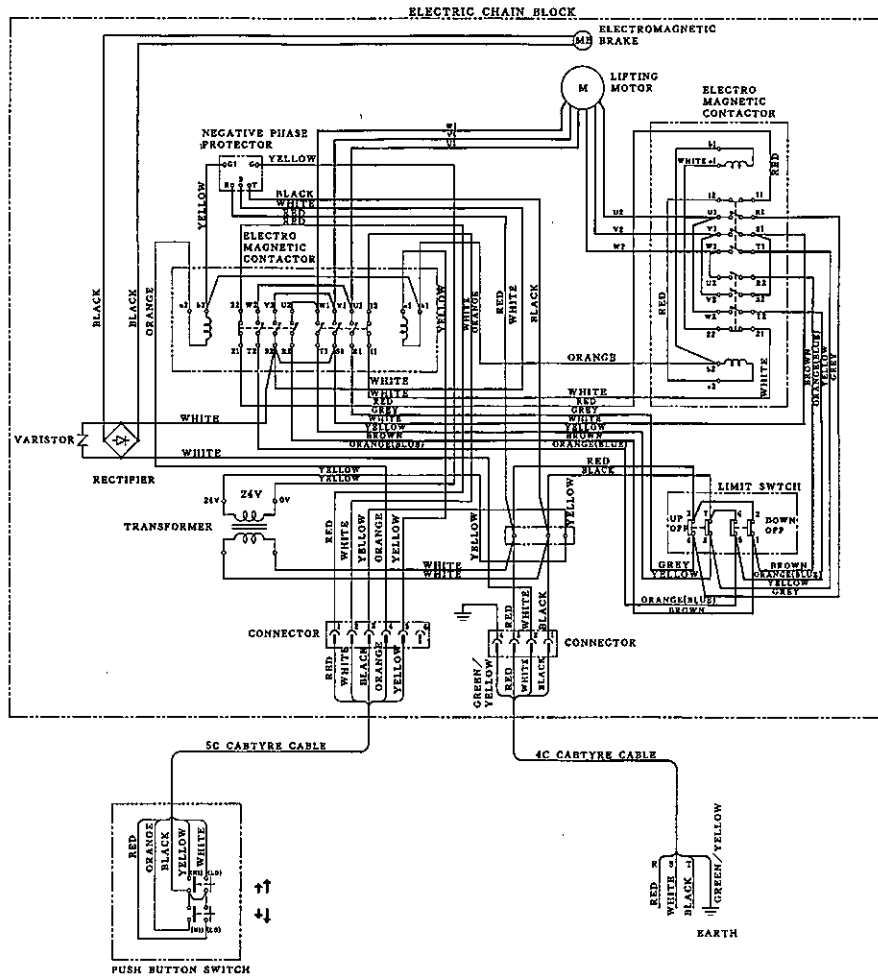

SA:Type

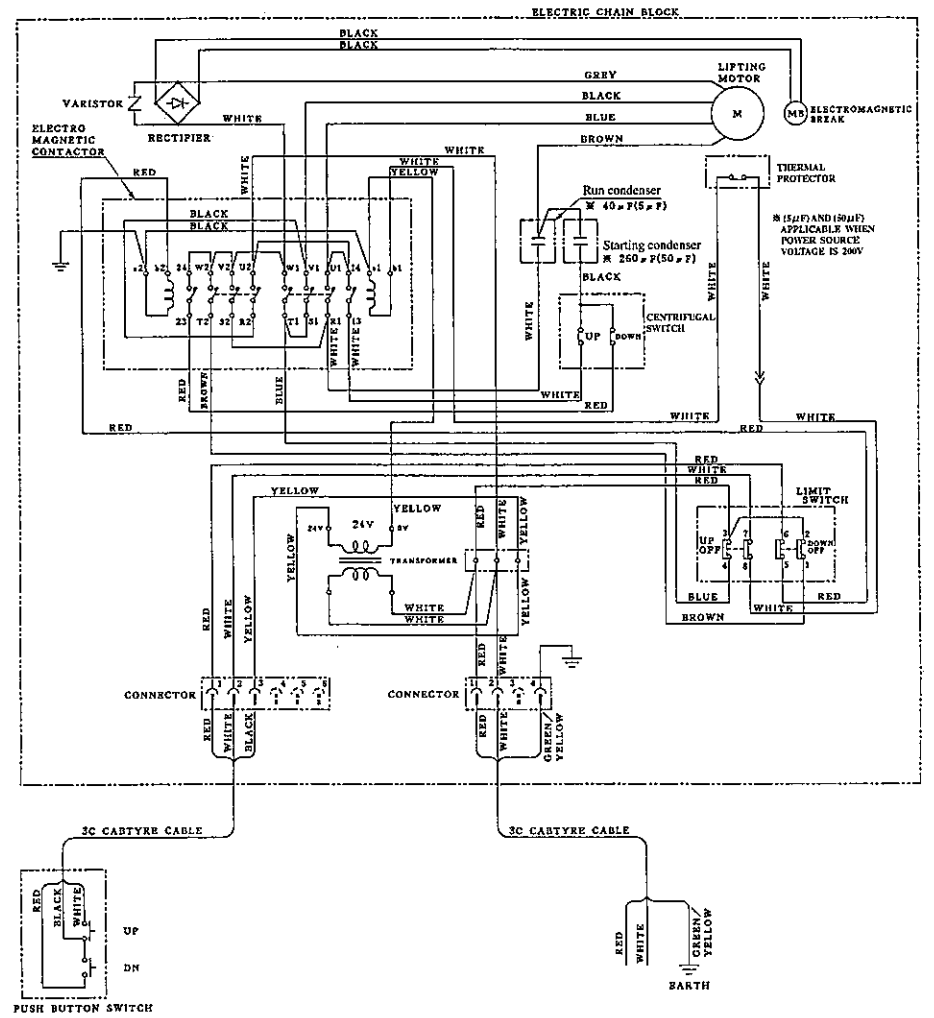

The goods has passed rigid inspection by us ahead of delivery in accordance with our standard in terms of test load and all other respects in good and satisfactory condition.

Inspector *Toshiyuki Morie*



ELEPHANT CHAIN BLOCK CO., LTD.

Osaka JAPAN