

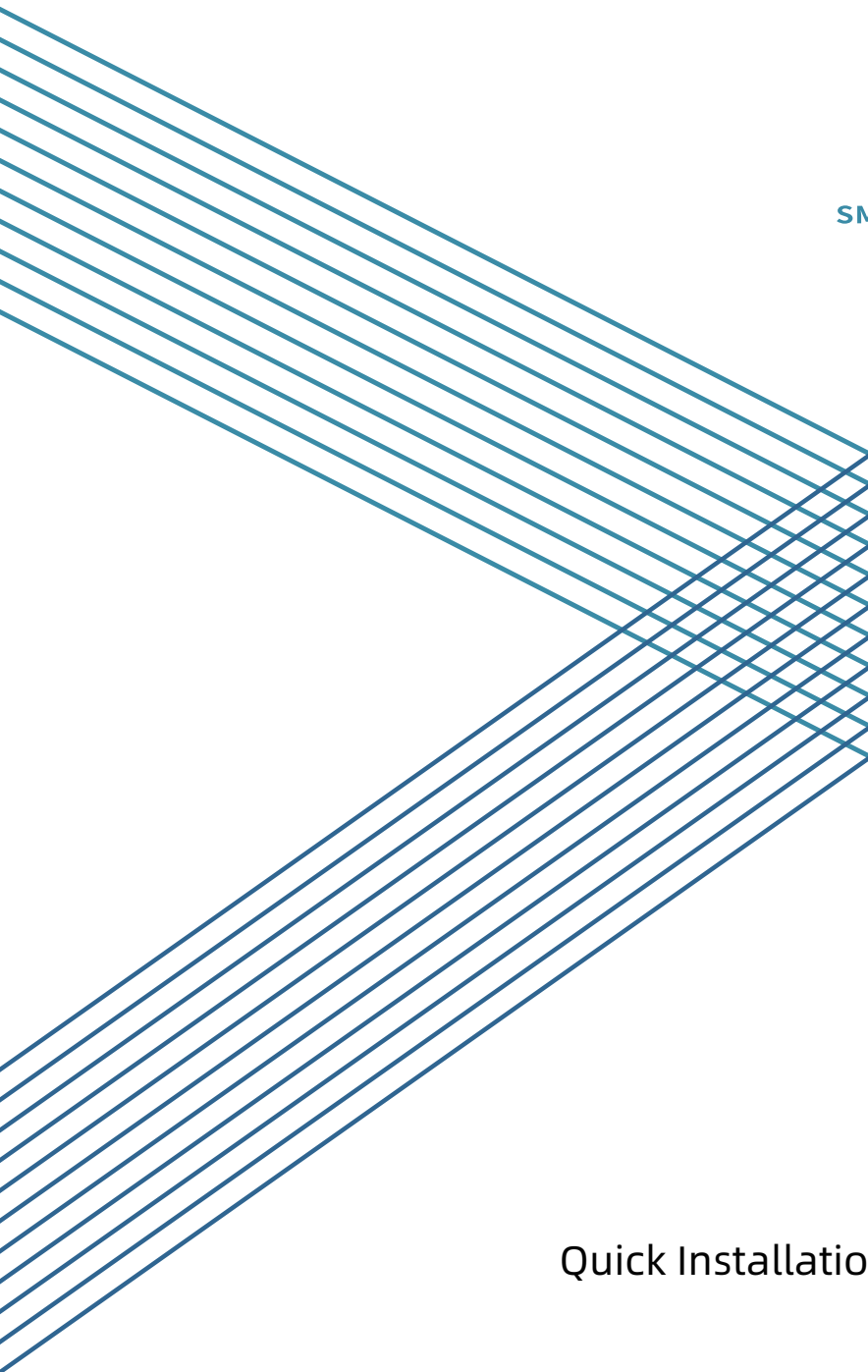

SMARTWINGS



Quick Installation Guide

Drapery

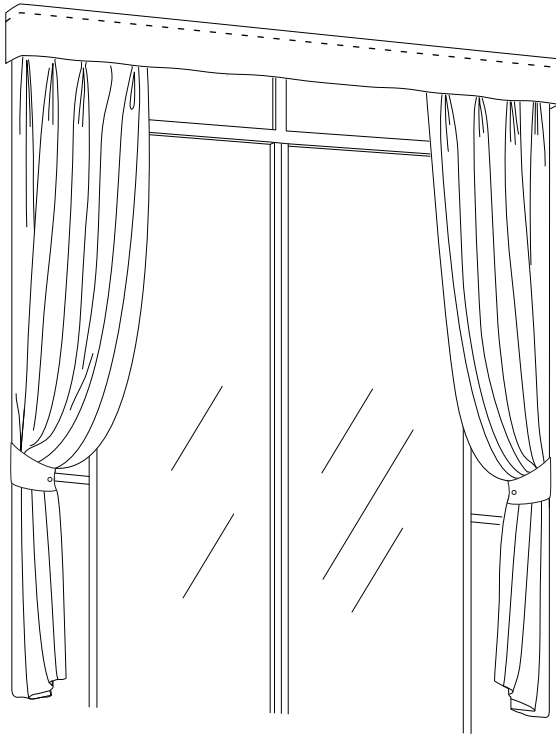
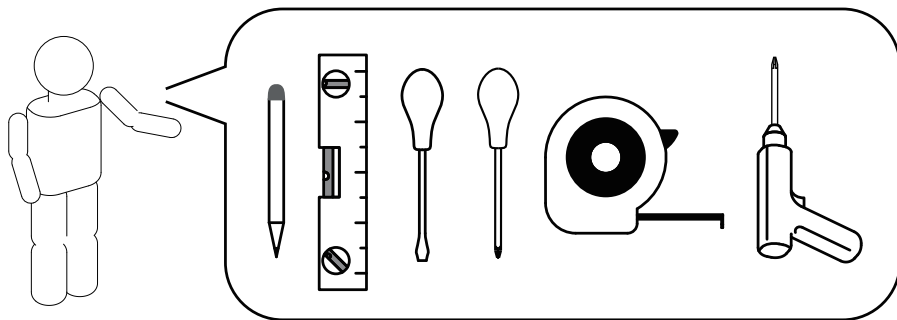

TABLE OF CONTENTS

1. Track Splicing.....	3
2. Fabric Hook Installation.....	8
3. Track Installation.....	9
3.1 Ceiling Mount.....	9
3.2 Wall Mount.....	11
4. Valance Installation.....	13
5. Motor Installation.....	14
6. Fabric Installation.....	15
7. Remote Holder Installation.....	16

TOOLS YOU WILL NEED :



PARTS INCLUDED :

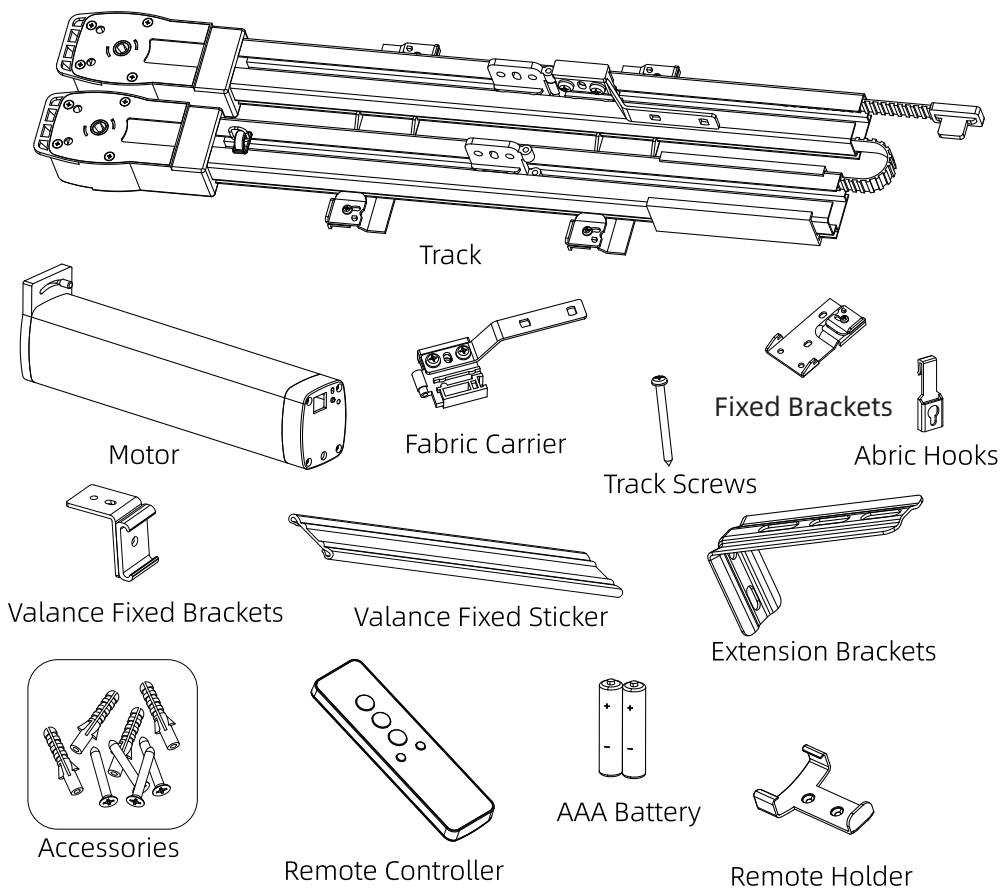

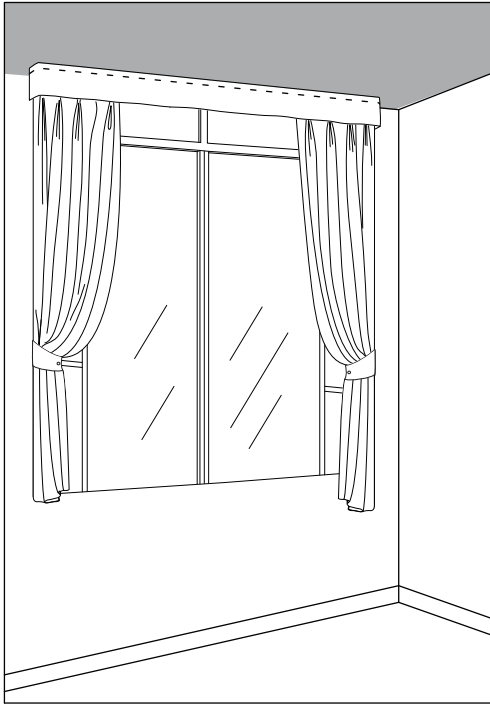

Ceiling Mount

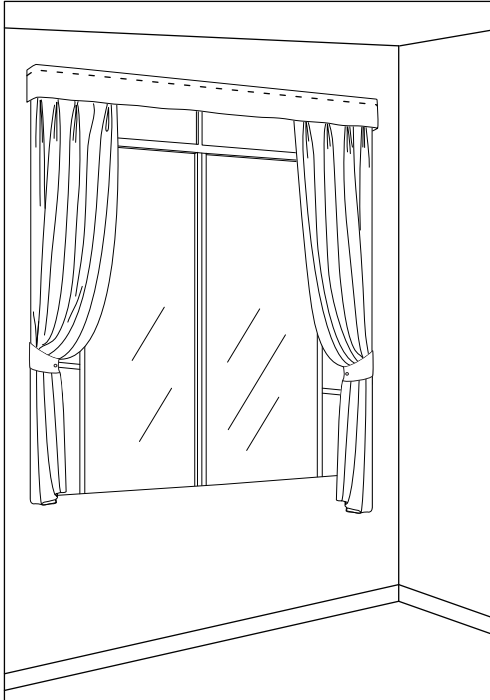

Wall Mount

Track Splicing

Peel off the protective plastic film from both ends of the track. If the track length is less than 102"(2600mm), this step can be skipped and please turn to page 4 because tracks under 102"(2600mm) remain as one piece without the need for joining. For tracks longer than 102"(2600mm), refer to page 3 for guidance, as they will be cut into 2 pieces.

Step 1 Unfold the folded track to install.

1. Sufficient distance needs to be reserved between the two ends of the track, when you install the track, make sure to put them on a sufficiently flat surface. (on a large table or on a clean floor).

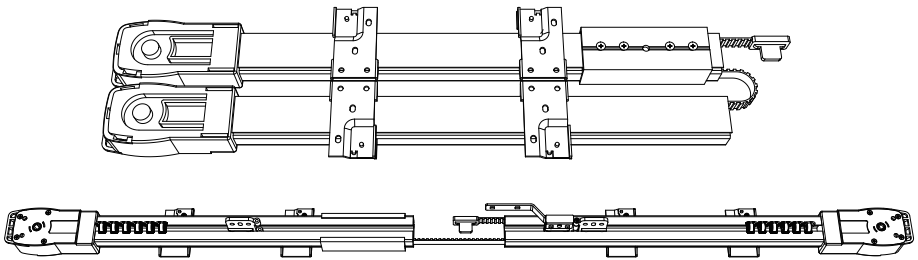

2. Prepare to install the overlap arm (Fig 2-a), it needs to be in the opposite direction to the pre-installed overlap arm (Fig 2-b), use the belt buckle (Fig 2-c) at the end of the belt to thread the overlap arm.

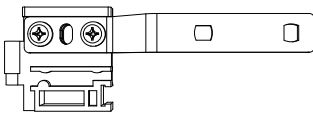

Fig 2-a

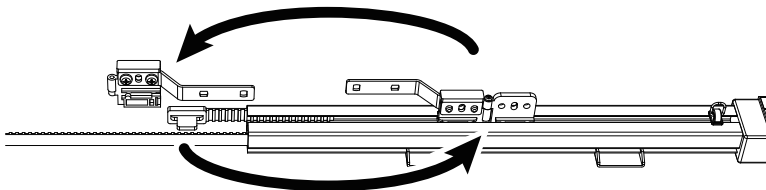

Fig 2-b

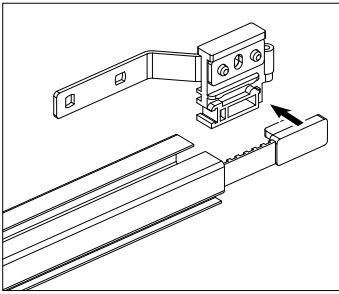

Fig 2-c

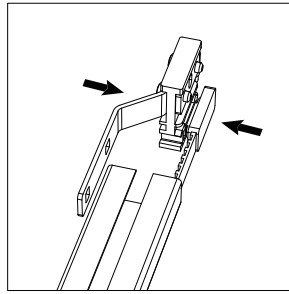

Fig 2-d

3. Put the belt buckle and overlap arm into the track (Fig 1-a), please align the combined belt buckle and overlap arm with the designated position on the track (Fig 3-c), and then slide into the track (Fig 3-d).

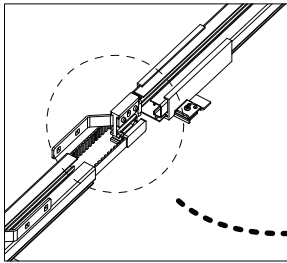

Fig 3-a

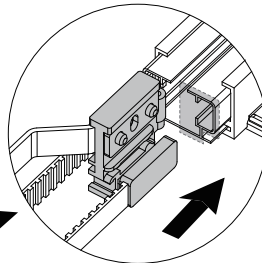

Fig 3-b

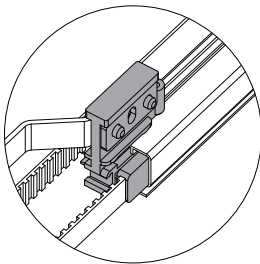

Fig 3-c

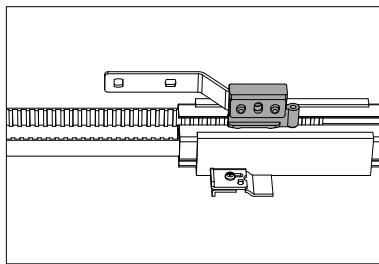

Fig 3-d

4. Now you will splice the overlap arm and the slip part on the track, pull the overlap arm and the slip part by hand to put them together(Fig 4-a), and after joining them (Fig 4-b), the two pieces of track will automatically move closer together (Fig 4-c).

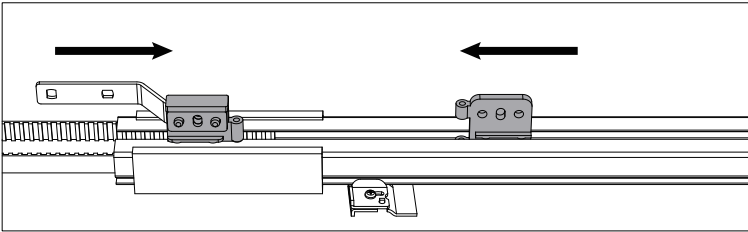

Fig 4-a

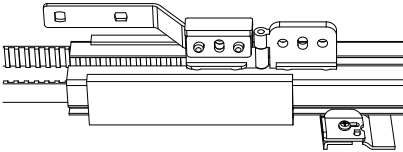

Fig 4-b

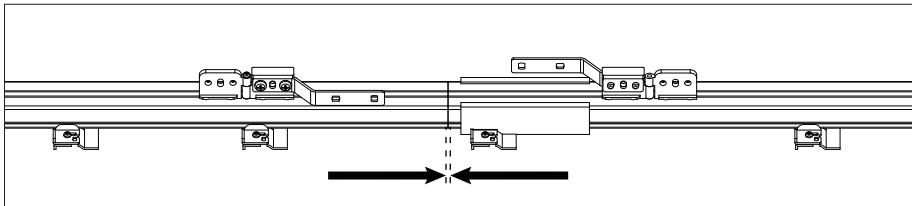

Fig 4-c

5. Align the two round holes of the overlap arm and the slip part (Fig 5-a), put the screws(Fig 5-b) from the kit into the overlapping round holes (Fig 5-c), and tighten them with a screwdriver (Fig 5-d).

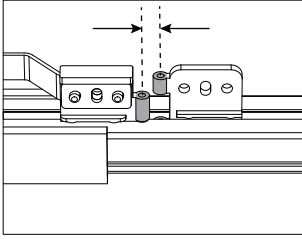

Fig 5-a

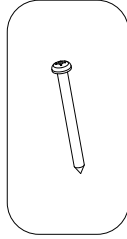

Fig 5-b

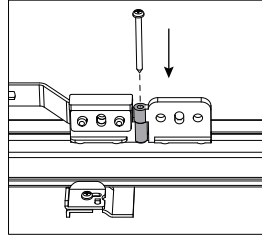

Fig 5-c

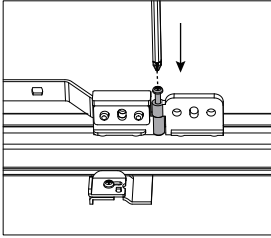

Fig 5-d

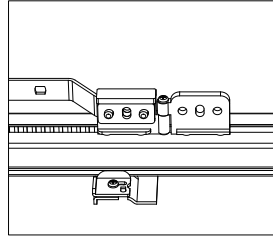

Fig 5-e

Step 2 Loosen Screws

Loosen the four screws on the track joint bracket connecting the two tracks.

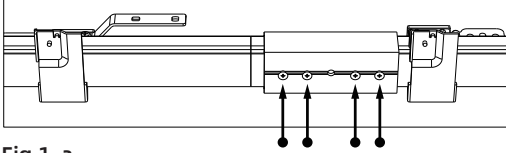

Fig 1-a

Step 3 Align Tracks

Flip the track over and align the two tracks.

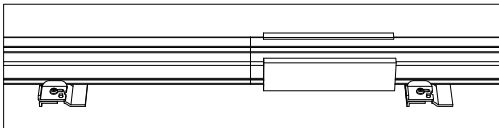

Fig 1-b

Step 4 Adjust Position

Slide the track joint bracket to the point where the two tracks disconnect. Aim to center the bracket at the disconnect point.

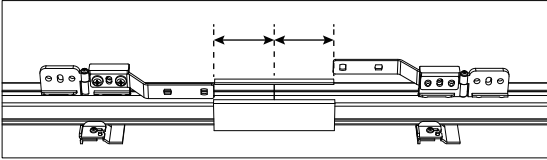

Fig 1-c

Step 5 Tighten Screws

Flip the drapery back and tighten the four screws securely.

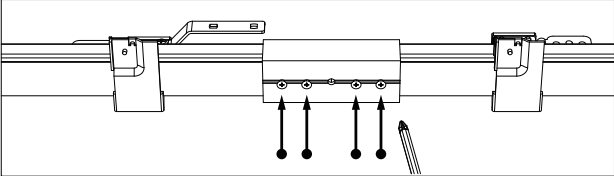

Fig 1-d

Fabric Hook Installation

After installing the fabric hook, use it to elegantly cover the end of the track and conceal the motor for a more aesthetically pleasing look. The effect shows as Fig 2-c.

Insert the fabric hook with the hooked end facing up into either of the two smaller holes on the end (this step cannot be installed after the track is secured to the ceiling (next step)).

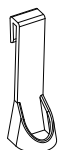

Fig 2-a

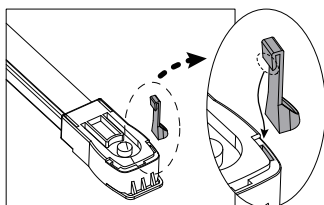

Fig 2-b

With Fabric Hook

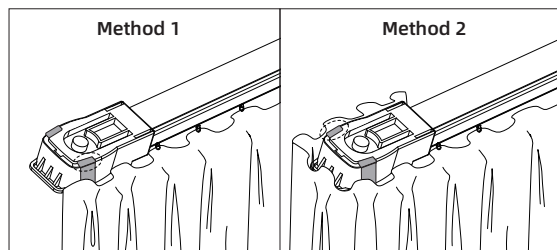

Fig 2-c

Without Fabric Hook

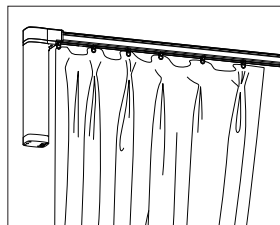

Fig 2-d

Track Installation

Choose between ceiling or wall installation for your drapery. If installing on the ceiling, fixed brackets should be used, then the installation steps refer to page 5. For wall installation, install both fixed brackets and extension brackets according to page 7.

Ceiling Mount

Install the track, the fixed brackets should be used.

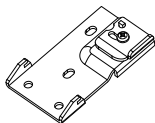

Fig 3.1-a

Step 1 Install the Fixed Bracket

Rotate the lower metal buckle of the fixed bracket clockwise to the right. Snap the bracket onto the track. Return the metal buckle to its original position. Tighten the screws securely, ensuring they are firmly in place. Double-check to ensure the attachment is securely fixed.

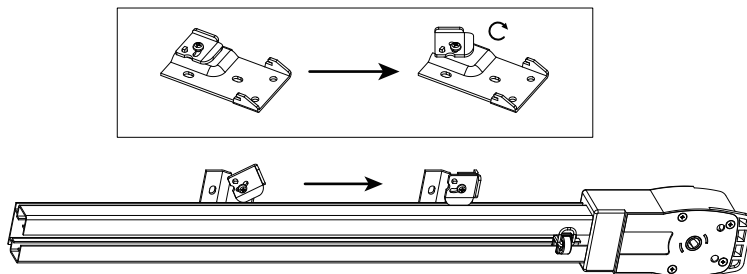

Fig 3.1-b

* When installing it on the wall or ceiling, please install screws in the 3 screw holes reserved for the fixed bracket.

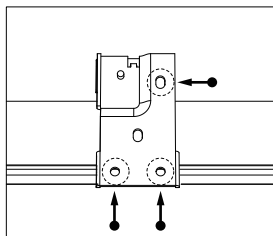

Fig 3.1-c

Step 2 Install track to the Wall

Follow the direction indicated in the picture and use the screws in the accessory bag to install the track.

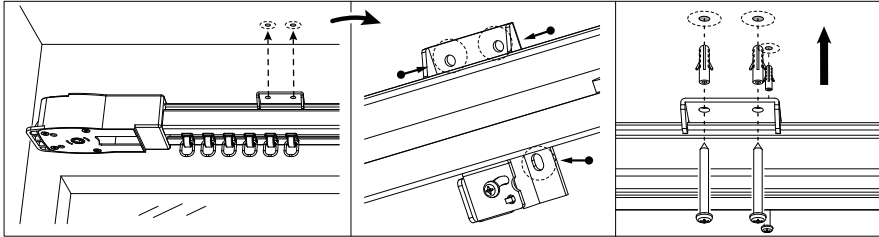

Fig 3.1-d

Track Installation

Wall Mount

Install the drapery on the wall, extension brackets should be used.

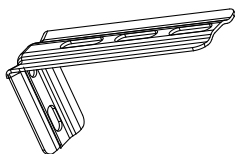

Fig 3.2-a

Step 1 Install the Extension Bracket

Align the bend in the extension bracket with the line on the wall you just drew.

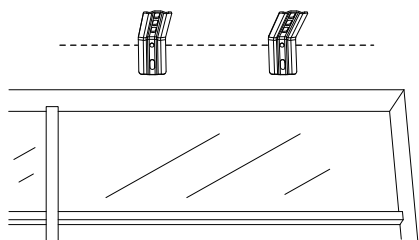

Fig 3.2-b

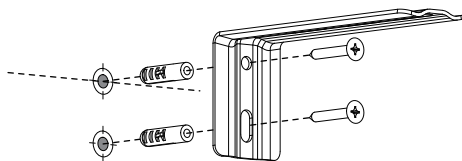

Fig 3.2-c

Step 2 Install the Fixed Bracket

Rotate the lower metal buckle of the fixed bracket clockwise to the right. Snap the bracket onto the track. Return the metal buckle to its original position. Tighten the screws securely, ensuring they are firmly in place. Double-check to ensure the attachment is securely fixed.

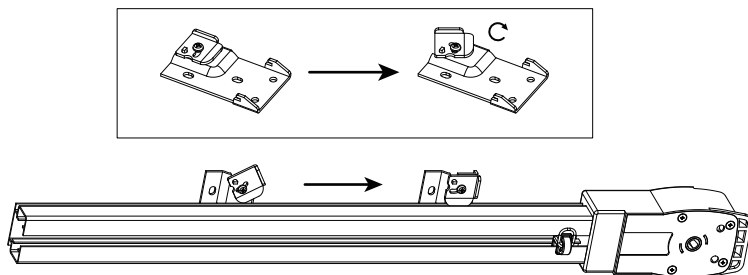

Fig 3.2-d

Step 3 Install track to Extension Bracket

Place the extension bracket on top of the fixed bracket, align the two holes and secure with the screws.

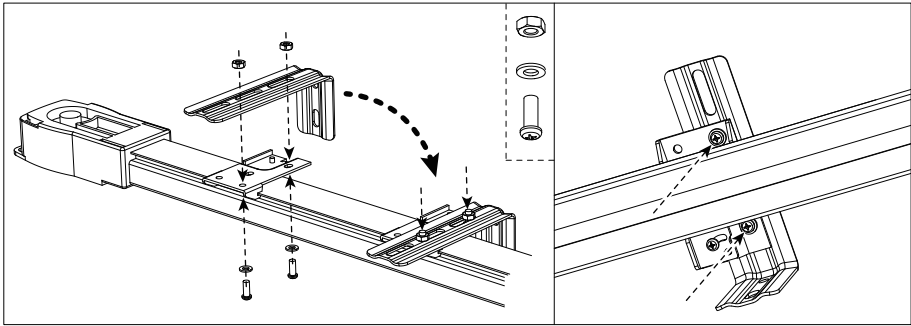

Fig 3.2-e

Valance Installation

If you haven't purchased the valance or are installing the drapery on the ceiling, you can skip this step. Proceed to page 10.

Step 1 Install Valance Fixed Bracket

Install valance fixed bracket by putting screw in mounting hole and using bolt to Lock.

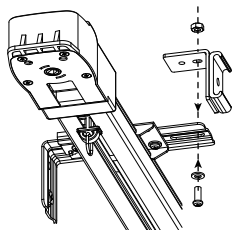

Fig 4-a

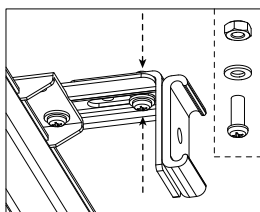

Fig 4-b

Step 2 Insert the valance fixed sticker

You can bend the valance fixed sticker with the help of the hard object so that it can better cover Track.

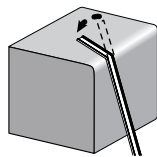

Fig 4-c

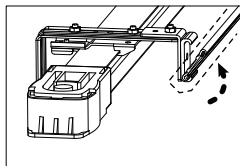

Fig 4-d

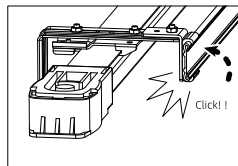

Fig 4-e

Step 3 Attach the Valance

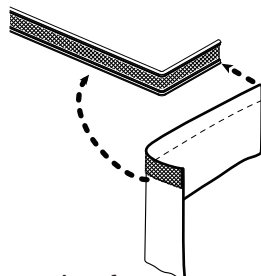

Fig 4-f

Motor Installation

Pull down and forward of the knob located under the motor to unlock it. Align the holes at the end of the track and insert the motor. Turn the pull knob back to its original position to securely lock the motor in place.

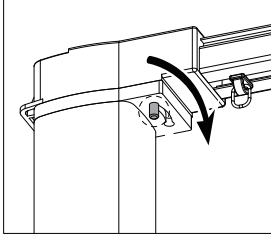

Fig 5-a

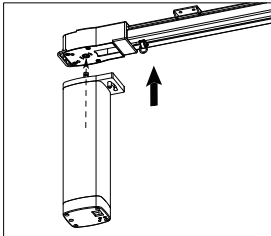

Fig 5-b

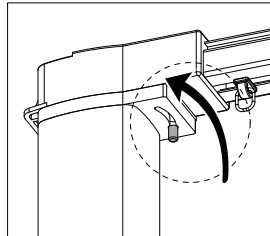

Fig 5-c

If you want to remove the motor, just repeat the last step.

Fabric Installation

Match the hooks on the drapery fabric with the hanging wheels on the track one by one. Additionally, you have the flexibility to fine-tune the drapery by adjusting the hooks up or down.

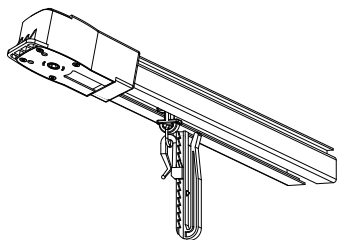

Fig 6-a

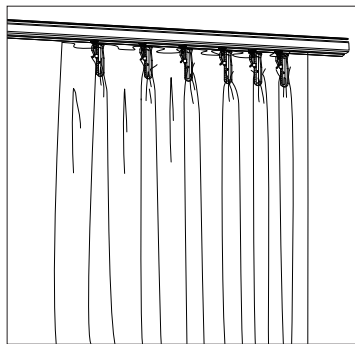

Fig 6-b

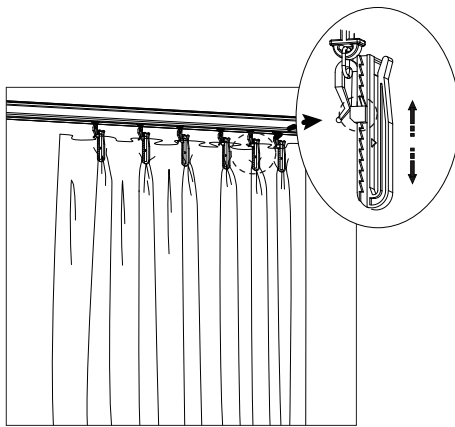
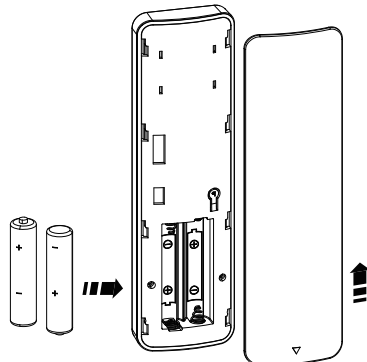
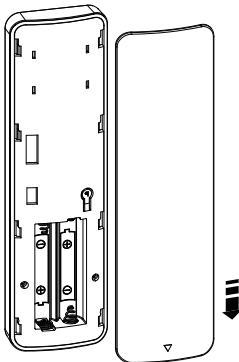
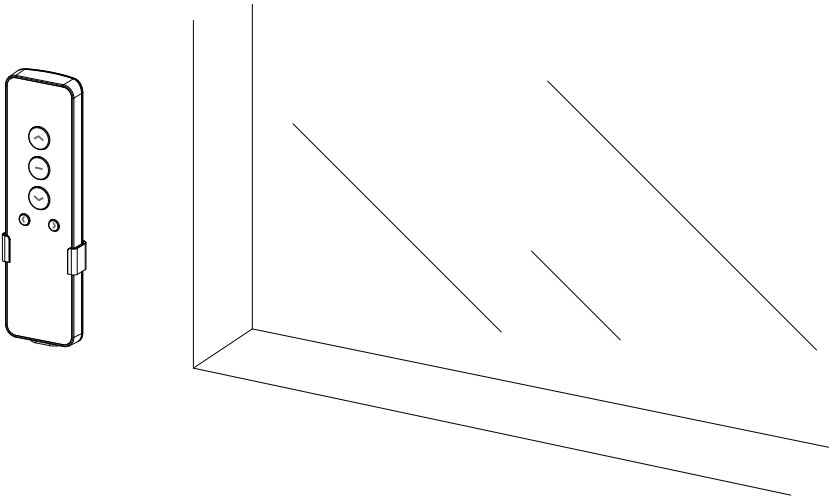
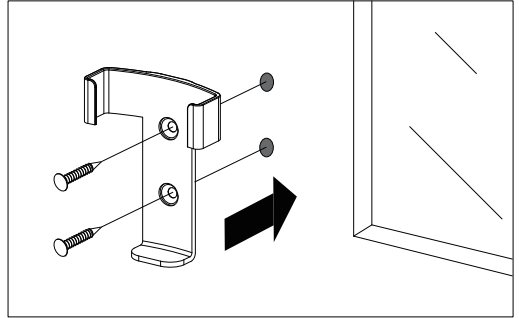
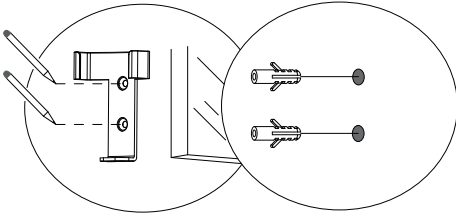

Fig 6-c

Remote Holder Installation





SMARTWINGS

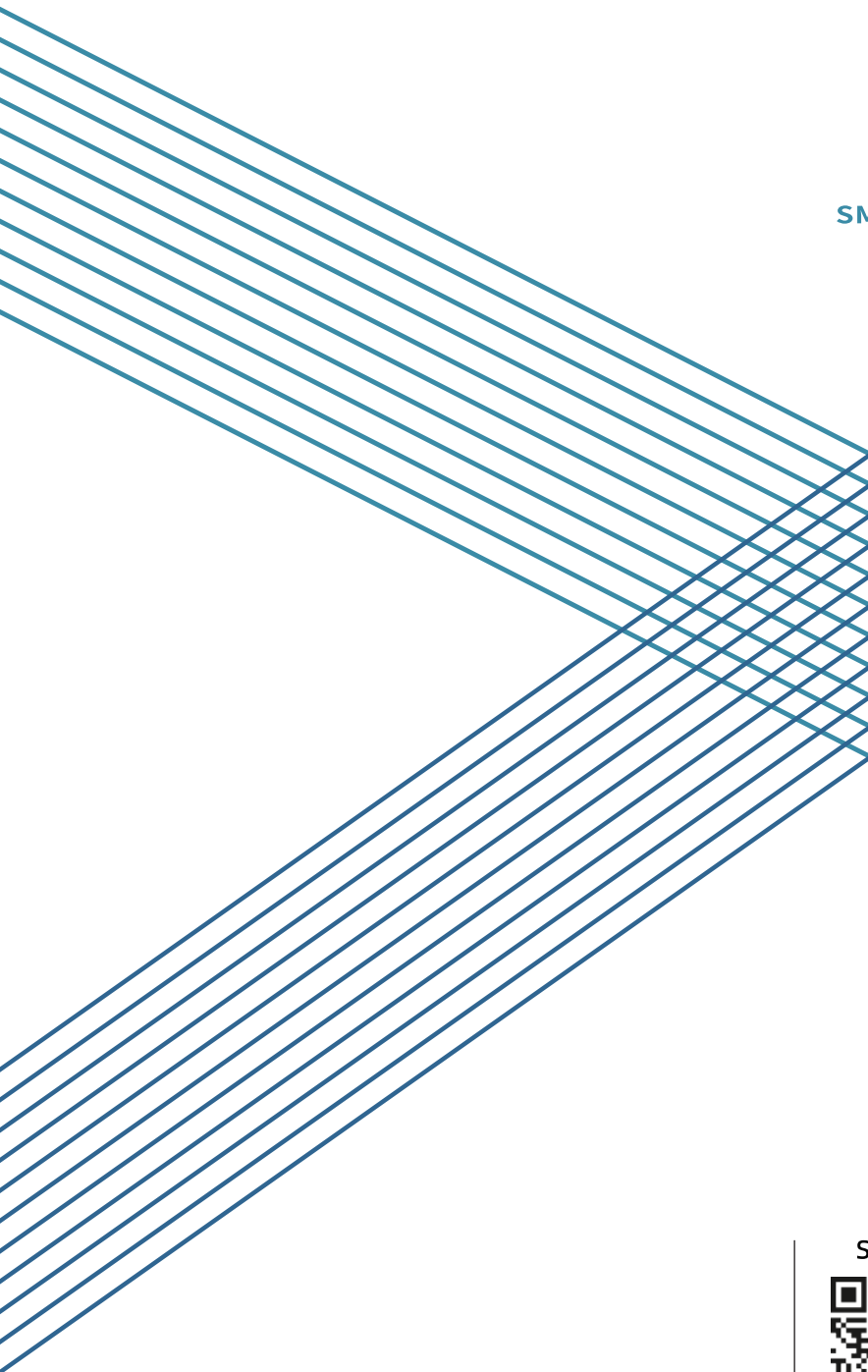

Social Media



T +1 877 762 7861

www.smartwingshome.com

support@smartwingshome.com