

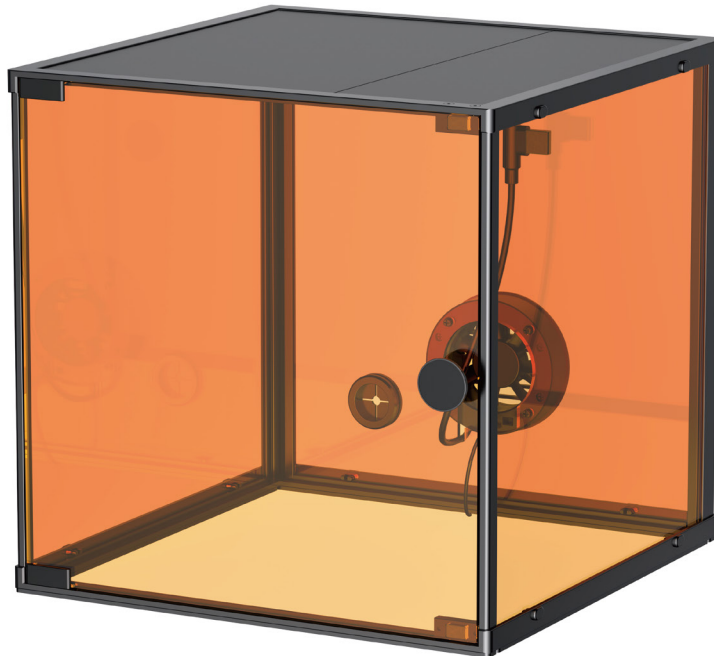

LaserPecker 2 & LaserPecker 3

Laser Protection Cover User Manual



After-Sales Services

- Technical support for this product is available globally. Please contact us if you encounter any problem with your LaserPecker 2 & 3 laser protection coverand, we will get back to you as soon as possible.
- Email: support@laserpecker.com
- Tel: +86 0755-28913864

Online User Community

- LaserPecker's huge online global community connects our diverse group of dedicated users and offers support, inspiration, and a showcase for sharing creativity.
- Facebook: [LaserPecker 2](#) Facebook: [LaserPecker 3](#)



LaserPecker 2
VIP Group



LaserPecker 3
VIP Group

Component List

Tri-fold Protective Shields*1



Door Shield*1



Top Retainer Plate*1



Bottom Fixed Frame*1

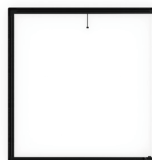

Black Top Panel*2



Lock *12



USB HUB *1



User Manual *1



Component Overview

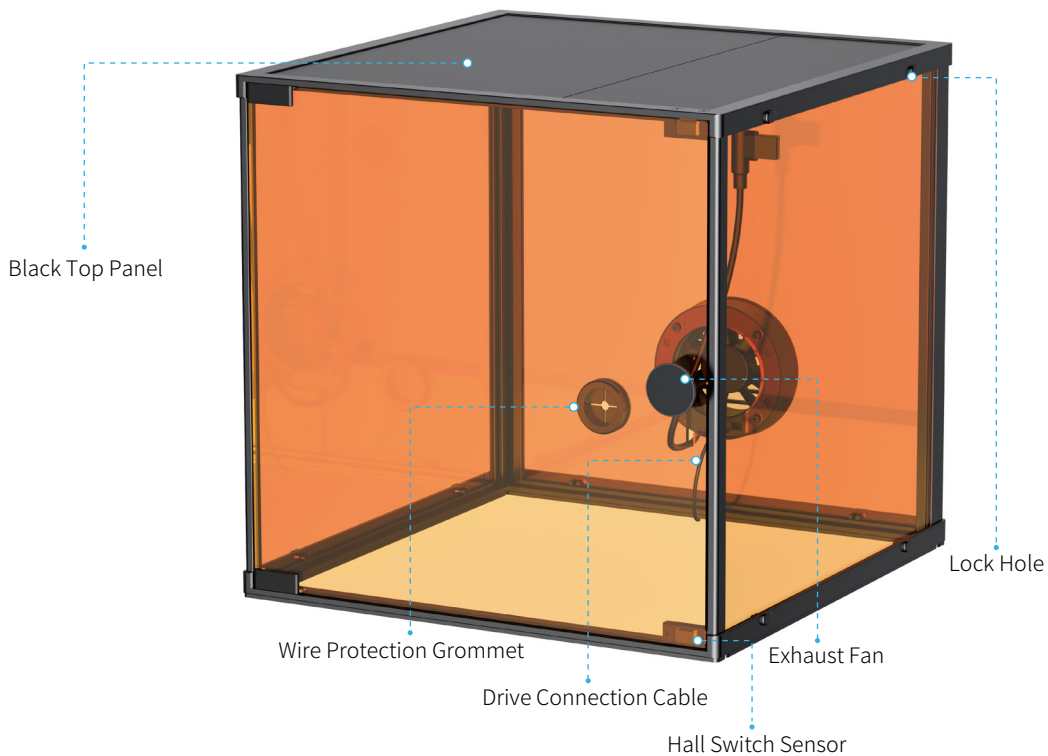

03/Fast Assembly Guide

- 1 Place the bottom fixed frame on a flat surface as shown below.

Tips: The side with a drive connection cable is the back of the protection cover.



- 2 Fold the tri-fold protective shields inward by 90° as shown below.

Tips: The side with an exhaust fan is the back of the cover.

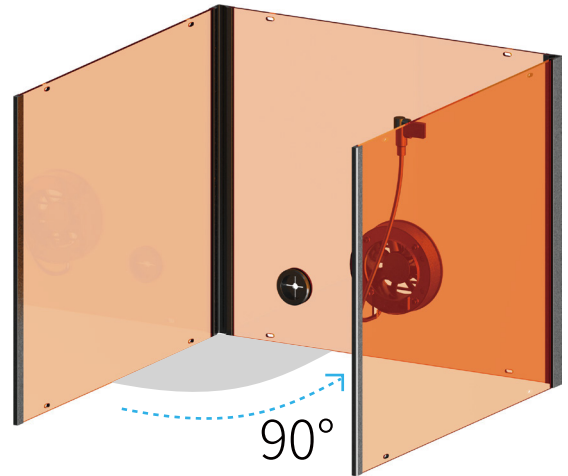

3 Install the tri-fold protective shields to the bottom fixed frame as shown below.

Tips: Please put both the drive and fan connection cable inside of the protection cover during installation, and ensure the shields are tightly fixed with the frame.

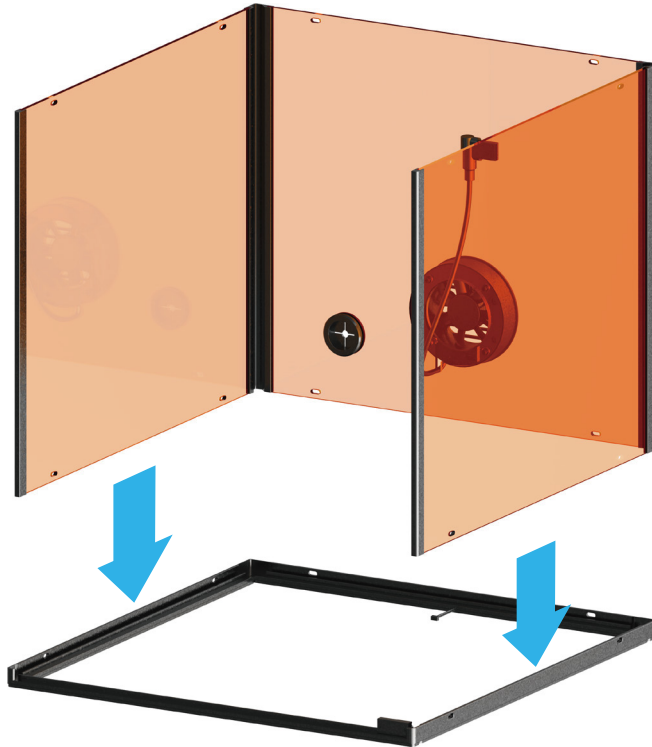

- 4 Insert six locks into three sides of the bottom fixed frame and fix the drive connection cable as shown below.

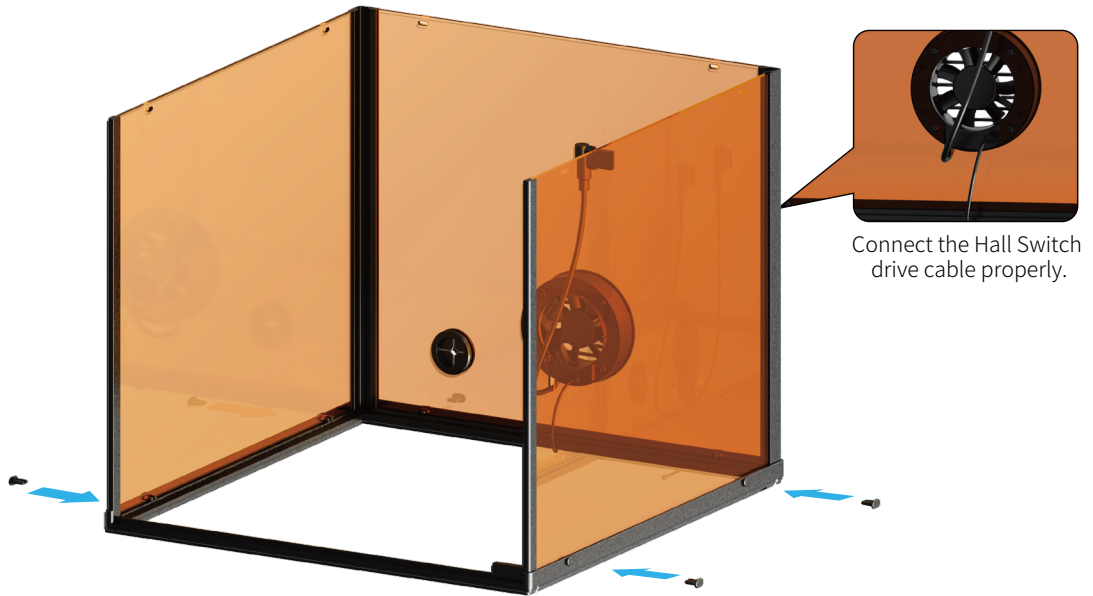

- 5 Put the top retainer plate on the tri-fold protective shields as shown.

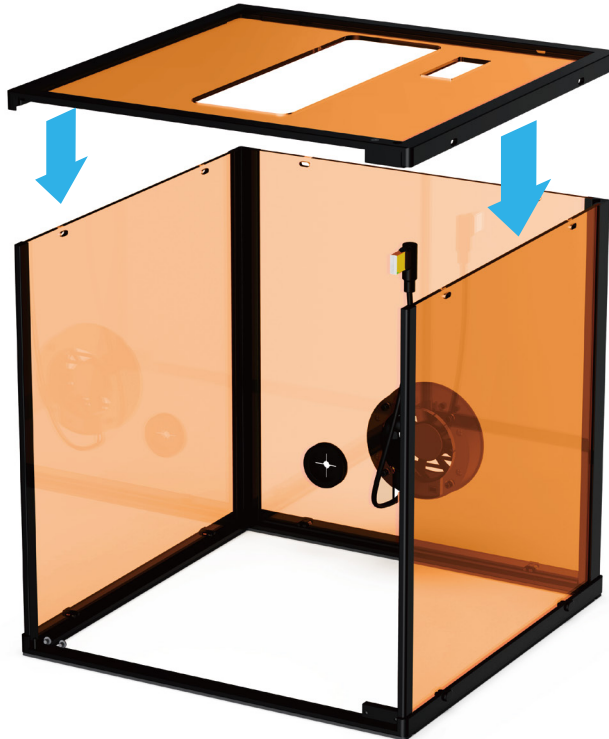

- 6 Install the door shield by aligning the side with dowel pin to the upper and lower mounting holes.

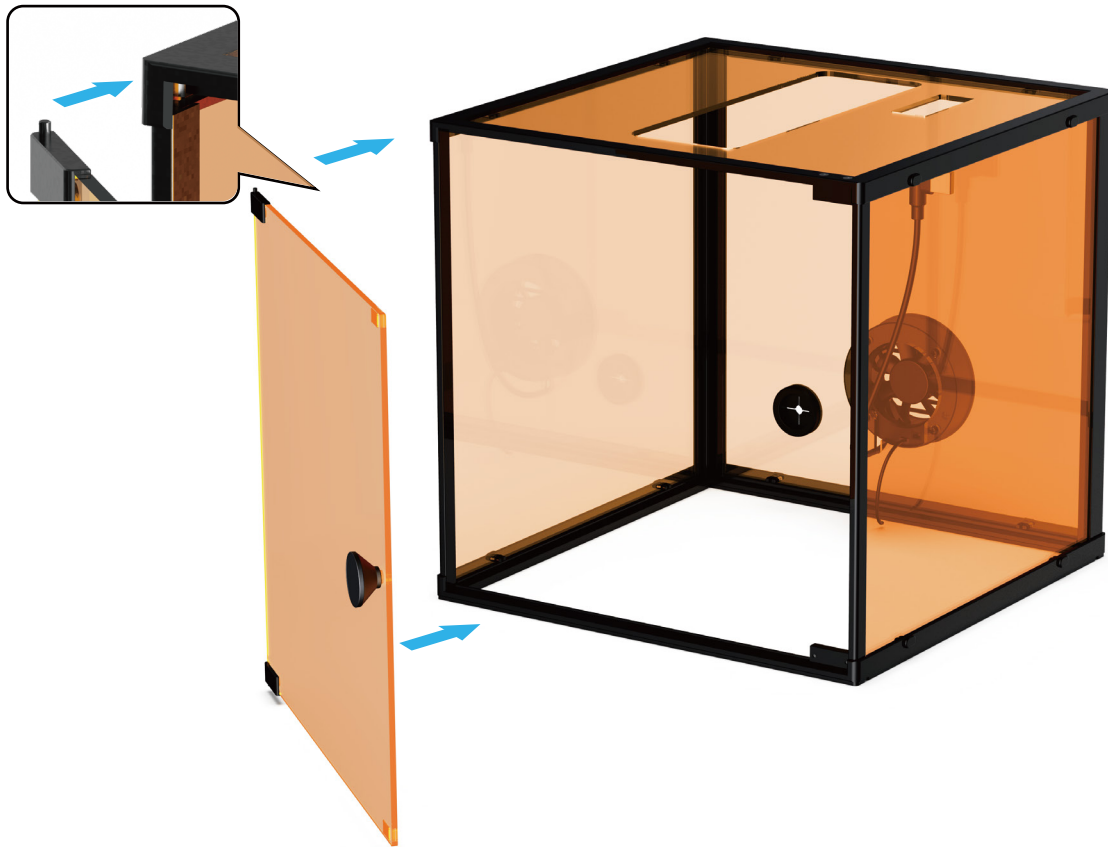

- 7 Press the top retainer plate and insert locks into its three sides.

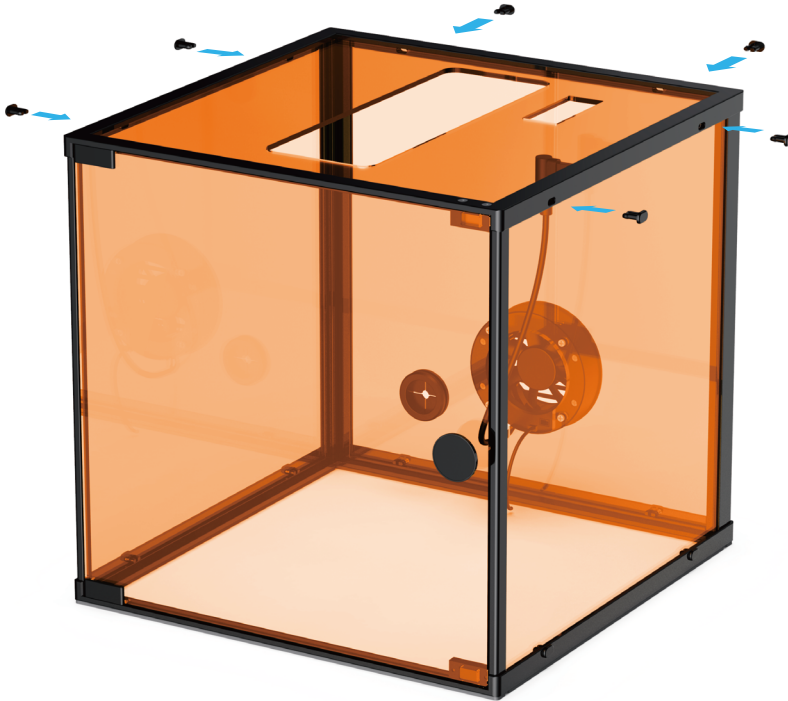

- 8 Cover it to LaserPecker 2 & LaserPecker 3 by aligning to the hole position. Adjust the position to make them perfectly match.

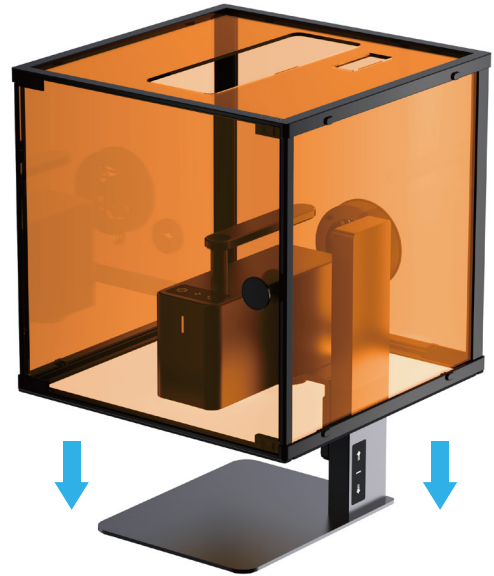
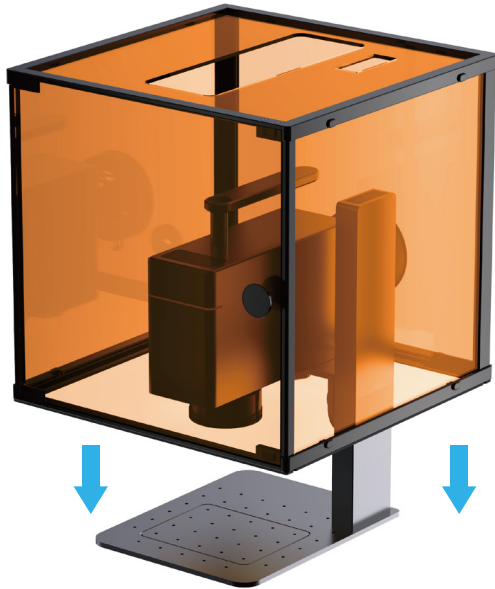

- 9 Connect the exhaust fan's cable from the bottom, and connect the power cable from the wire protection grommet as shown below.

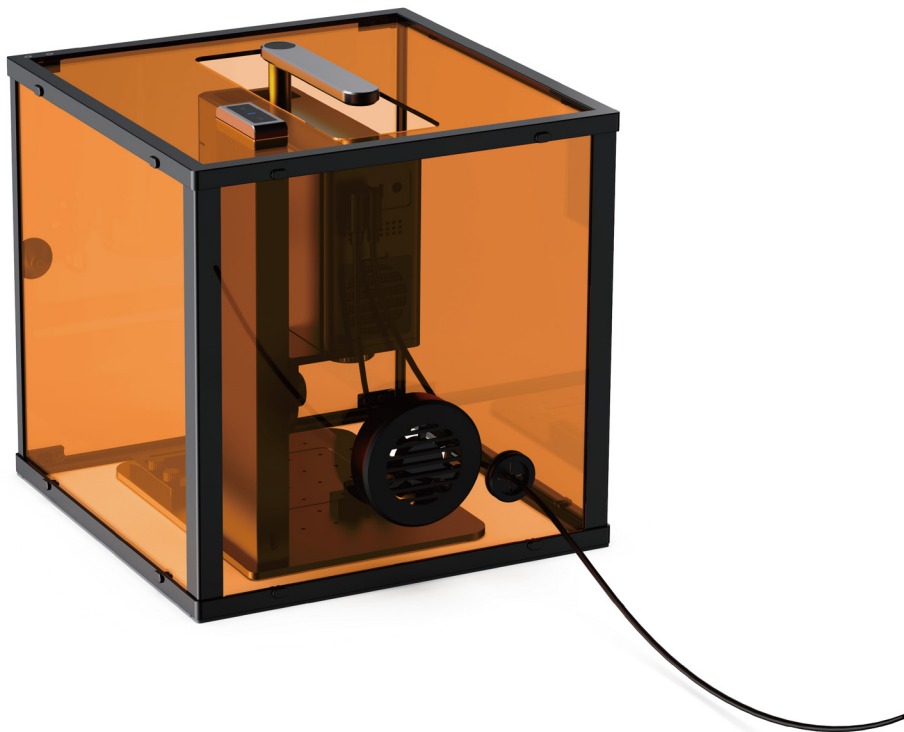

Expanded Use- Connect the Power Cable

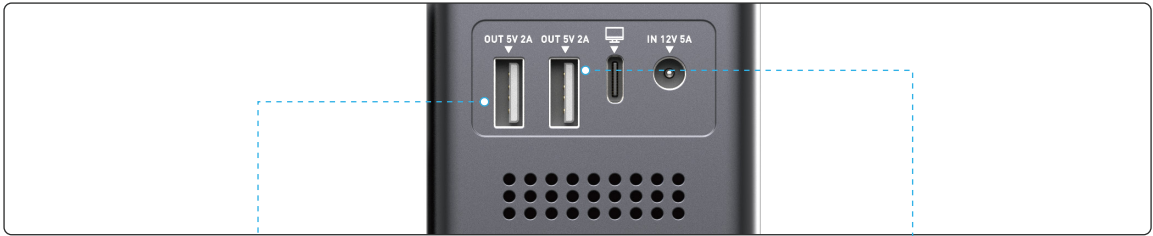

Connect the Accessories



Connect the Laser Protection Cover and the Electric Stand

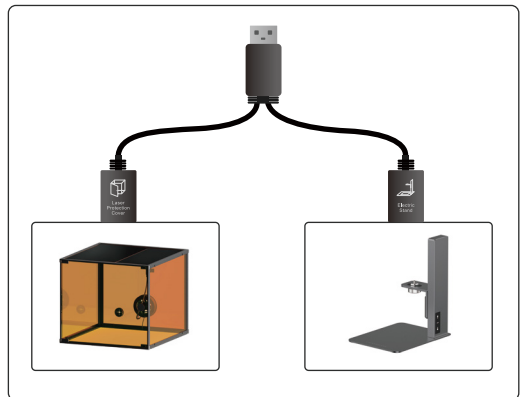

Product Specifications

Compatibility	LP Air Purifier, Slide Extension, Rotary Extension
Size	287*263*257mm
Wight	1443.5g
Material	Plastics & Acrylic & Aluminium Alloy
Filtered Laser Wavelength	Wavelength Range 190nm-550nm, 800nm-1100nm
Certification	CE, ROHS, FCC, PSE, CA65, UKCA, KC

LaserPecker

Shenzhen Hingin Technology Co., Ltd.

We provide global online technical support services for this product. If you encounter any problems during your use, please contact us via:

Email: support@laserpecker.net | Tel: +86 0755-28913864