

LA PIAZZA



WOOD OVENS

OWNER'S MANUAL

ASSEMBLY & OPERATING INSTRUCTIONS



WARNING

READ AND FOLLOW ALL SAFETY WARNINGS AND INSTRUCTIONS IN THIS MANUAL TO AVOID PERSONAL INJURY OR PROPERTY DAMAGE.

WOP-1207

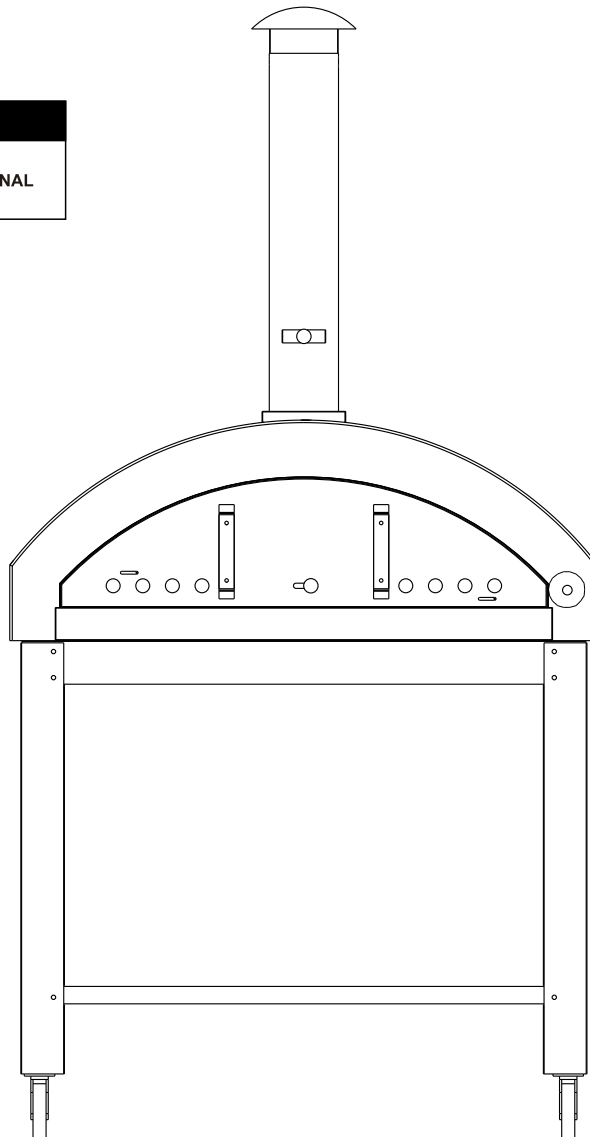

User Instructions - Please keep for future reference

IMPORTANT – Carefully remove any packaging before use, but retain the safety instructions.

These instructions form part of the product.

Please take note of all of the safety warnings listed in these instructions.

Please read these instructions in their entirety and retain them for future reference.









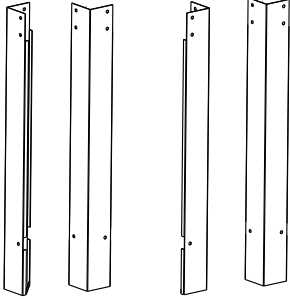

These instructions should be stored with the product.

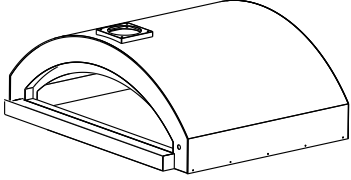
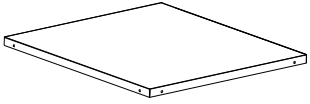
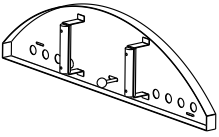
This product is for outdoor using.

www.lapiazzawoodovens.com

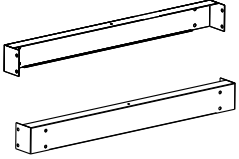
Prior to assembly, read the instructions carefully. Check all parts against the parts list. Carry out assembly on a soft surface to avoid scratching the paint. Please retain this information for future reference. For ease of assembly only loosely tighten bolts and then tighten fully when assembly is complete.

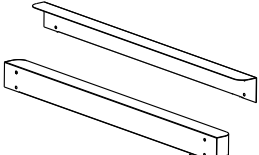
Parts list

1 (1x)		Chimney Cap	7 (4x)		Cart section
2 (1x)		Chimney			
3 (1x)		Oven body	8 (1x)		Bottom shelf
4 (1x)		Door	9 (4x)		Wheel(2x)
					Wheel with brake (2x)
			A(42x)		M8 Bolt
5 (2x)		Bracket (left/right)	B(42x)		Φ8 Flat Washer
			C(16x)		Φ8 Spring Washer
6 (2x)		Bracket (front/back)	D(24x)		M8 Nut
			E(3x)		M5 Bolt

Assembly Instructions and Diagram

IMPORTANT - Remove any packaging before use, but retain the safety instructions and store them with this product.

ASSEMBLY

STEP 1 - Attach 4 x cart section (7) to 2 x bracket (6) and 2 x bracket (5) by 16 x M8 bolts (A), and using 16 x $\Phi 8$ washers (B), 16 x M8 nuts(D) to fix in the back .

Enlarged view A shows you how to work.

STEP 2 -Place 1 x bottom shelf (8) to assembled cart section by 8 x M8 bolts (A) ,and using 8 x $\Phi 8$ washers (B), 8 x M8 nuts(D) to fix in the back.

STEP 3 -Attach 2 x wheels (9) and 2 x wheels with brake (in front) to well-assembled cart by 16 x M8 bolts (A) and fixing by 16 x $\Phi 8$ washers (B), 16 x $\Phi 8$ washers (C) in the back of cart section (7). Enlarged view B shows you how to work.

STEP 4 -Please make sure all bolts and nuts are tightened fully.

STEP 5 -Attach 1 x oven body (3) to well assembled cart and securing by 2 x $\Phi 8$ washers (B) and 2 x M8 bolts (A).

Note - take care when handling, caution heavy load. You should seek assistance to lift this oven.

STEP 6 -Attach 1 x chimney cap (1) to chimney (2) by 3 x M5 screws (E). Then, place it to oven body (3).

STEP 7 - Attach 1 x door (4) to oven body (3).

The oven is now ready to use but please ensure you have read these instructions thoroughly prior to use.

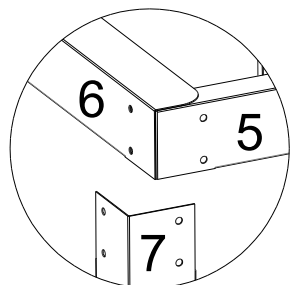

Enlarged View A

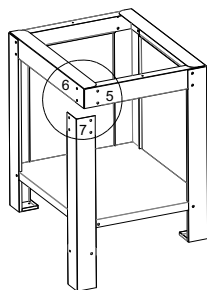

View A

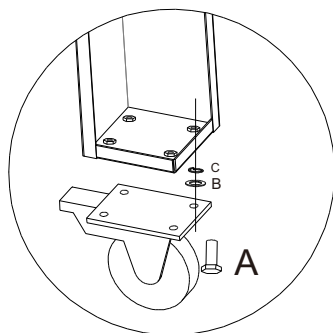

Enlarged View B

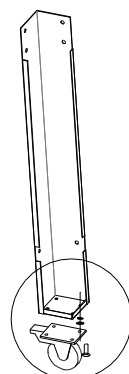

View B

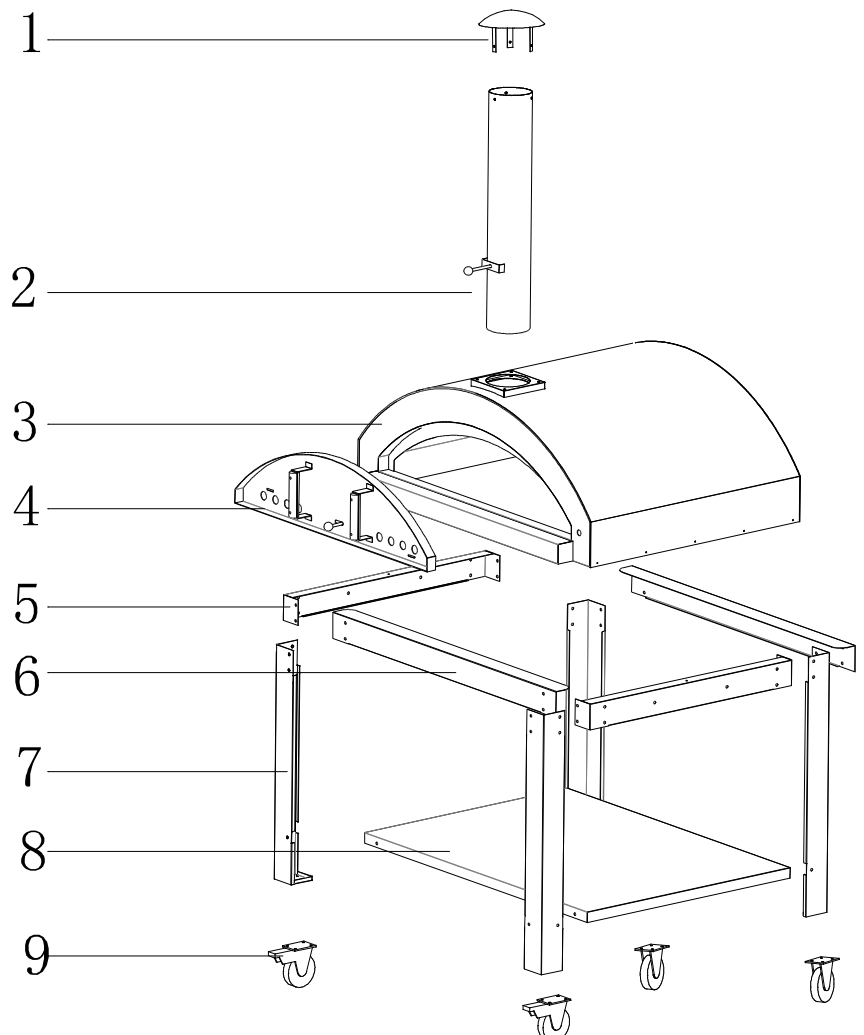

Care and Safe Use Guidelines

WARNING!

- This product is intended **FOR OUTDOOR USE ONLY. DO NOT USE INDOORS.**
- **NEVER** leave a burning fire unattended.
- **DANGER** of carbon monoxide poisoning - **NEVER** light this product or let it smoulder or cool down in confined spaces.
- **DO NOT** use this product in a tent, caravan, car, cellar, loft or on a boat.
- **DO NOT** use under any awnings, parasols or gazebos.
- **DO NOT** overload the unit with fuel.
- **FIRE HAZARD** - Hot embers may emit while in use.
- **WARNING - DO NOT** use petrol, white spirit, lighter fluid, alcohol or other similar chemicals for lighting or relighting.
- This product is **ONLY** suitable for use with untreated wood, logs or charcoal.
- **DO NOT** use this oven on decking or any other flammable surfaces such as dry grass, wood chips, leaves or decorative bark.
- Ensure that the oven is positioned at least 2 metres away from flammable items.
- **DO NOT** use this oven as a furnace.
- **DO NOT** handle or move the oven whilst alight as it will be hot.
- **ALWAYS USE** heat resistant gloves when in use as the unit will be hot.
- Allow the unit to cool down completely before moving or storing.
- **ALWAYS** keep children and pets at a safe distance from the oven when in use.
- Always inspect the unit prior to use for fatigue and damage and replace as and when necessary.

POSITIONING, LIGHTING, USAGE AND CARE INFORMATION

- Ensure the oven is positioned on a permanent, flat, level, heat resistant non-flammable surface away from flammable items.
- Ensure the oven has a minimum of 2m overhead clearance and has a minimum 2m clearance from other surrounding items.
- Place untreated wood into oven. Do not use more fuel than 75% of fuel area capacity.
- Place rolled up newspaper and kindling in with the fuel and using heat resistant gloves light the fuel.
- Allow the fuel to heat up and be kept red hot for at least 30 minutes prior to the first cooking on the oven or pizza stone.
- **Do not** cook before the fuel has a coating of ash. If required, place the pizza stone in oven.
- Once the fuel has a coating of ash, place your food onto brick floor or pizza stone in the oven.
- If you wish to use as a smoker unit, add wood chips to the fuel and restrict air flow to the unit by closing damper on the chimney.
- Air flow can be adjusted as required via the damper on the chimney.
- Always use heat resistant gloves during the handling process and when refueling.
- The unit may be left outside all year if a weatherproof cover is used to help protect it from bad weather.

FOOD COOKING INFORMATION

- Please read and follow this advice when cooking.
- Always wash your hands before and after handling uncooked meat and before eating.
- Always keep raw meat away from cooked meat and other foods.
- Before cooking ensure brick surfaces and tools are clean and free of old food residues.
- **DO NOT** use the same utensils to handle cooked and uncooked foods.
- Ensure all meat is cooked thoroughly before eating.
- **CAUTION** - eating raw or under cooked meat can cause food poisoning (e.g. bacteria strains such as E.coli.)
- To reduce the risk of under cooked meat cut open to ensure it cooked all the way through.
- **CAUTION** - if meat has been cooked sufficiently the meat juices should be clear and there should be no traces of pink/red juice or meat colouring.
- Pre-cooking large pieces of meat and joints is recommended before finally cooking in your oven.
- After cooking always clean the cooking surfaces and utensils.
- **DO NOT** cook until your fuel has a coating of ash.

COOKING PIZZAS

- Place the pizza into the oven when it reaches optimum temperature.
- Allow the oven to reach approximately 350 - 400°F (175-200°C).
- Ensure that the damper on chimney is open.
- Check your pizza occasionally as they can cook quickly.
- Once its cooked to your taste, remove carefully using a paddle and heat resistant gloves (both not supplied).

COOKING OTHER FOODS

- This oven can be used to various other types of foods such as fish, meats, bread etc.
- Please fuel the oven as described under lighting section.
- To keep meat moist, add a small amount of water to a small foil tray, separate the coals in the lower fuel section and place the tray between the fuel prior to lighting.
- Top up liquid as necessary using heat resistant gloves (not supplied).

SMOKING

- If you wish to use as a smoker unit, add wood chips to the fuel and restrict air flow to the unit by closing the damper on the chimney.
- To keep meat moist, add a small amount of water to a small foil tray, separate the fuel in the fuel section and place the tray between the fuel prior to lighting.
- Top up liquid as necessary.

EXTINGUISHING

- To extinguish the unit - stop adding fuel and allow fire to die.
- **DO NOT** use water as this could damage the oven.

STORAGE

- When not in use, cover the oven with a waterproof cover once completely cooled.