

SEIT  
QUALITÄT



1896  
PRÄZISION

SCHILD

*Heinrich*

- AUTOMATIC -  
S W I S S

AS-5203

LIMITED EDITION

INSTRUCTION  
MANUAL





SCHILD



# SWISS MOVEMENT AUTOMATIC

This Limited Edition timepiece is equipped with a Swiss Made self-winding Mechanical Automatic movement manufactured by **Adolph Schild**.

## AS-5203

It does not need a battery. It is powered by the motions of the user's own wrist during the wear of the watch.

You may also choose to wind the watch manually.

# A) DISPLAY

Hour Hand

Minute Hand

Second Hand

Date

Screw  
Down  
Crown



## B) PLEASE READ THE FOLLOWING BEFORE UNSCREWING THE CROWN

### SCREW-DOWN CROWN

Screw-down crowns are used to ensure water resistance. **ALWAYS** be certain that your crown is securely screwed down ( Position [0] is secured. Positions [1], [2] and [3] are not secured for water resistance ).

**Do not** unscrew your crown while you are in any environment where moisture is present.

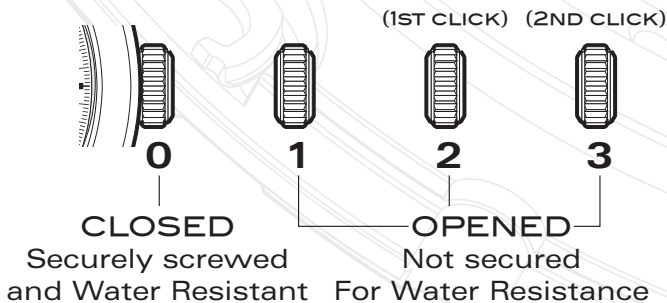

## C) USING THE SCREW-DOWN CROWN

**Do not** pull the crown unless it is **UNSCREWED** first:

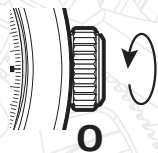

**TO UNSCREW:** Turn the crown anti-clockwise until it turns freely without tension.

GENTLY pull the crown out to the other desired positions for watch setting.

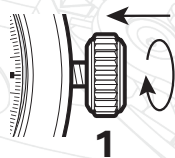

**TO SCREW:** Push the crown **ALL THE WAY IN** (towards the watch) THEN begin to turn clockwise until it is securely screwed down.

**NOTE:** Failure to **SECURELY** screw down the crown after setting the watch may affect its water resistance.

## D) WINDING THE MAINSPRING

THIS WATCH IS AN AUTOMATIC  
WATCH EQUIPPED WITH A MANUAL  
WINDING MECHANISM.

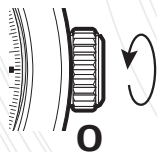

1. Unscrew the crown by turning it anti-clockwise.

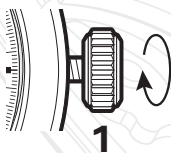

2. When it is in position [1], turn the crown clockwise to wind. Wind 5-10 times and it will start to move naturally after shaking slightly.

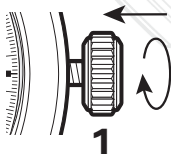

3. Push the crown in then screw it securely.



**NOTE:** This watch **MUST** be worn for at least 8 (Eight) hours each day to ensure it is fully wound.

An automatic watch will only wind when the watch is on your wrist and your arm moves.

Winding the watch by the crown will put power on the spring but not enough to allow the watch to function fully.

If your watch stops overnight or loses time it means it is not being fully wound.

***IMPORTANT NOTE:***

1. If your watch is running smoothly, please do not wind the crown to avoid overwinding the movement. Provided you are wearing the watch frequently, your watch should have sufficient power to operate without any fuss.
2. If your watch has stopped running after a period of not wearing the watch, gently move the watch side to side 20 to 30 times to move the rotor or gently turn the crown 5 to 10 times to get the second hand run at its normal speed.

## E) TIME SETTING

1. Unscrew the crown and pull it out to position **[3]**-(2nd click).
2. Turn the crown clockwise to set the correct time.
3. Push the crown in then screw it securely.

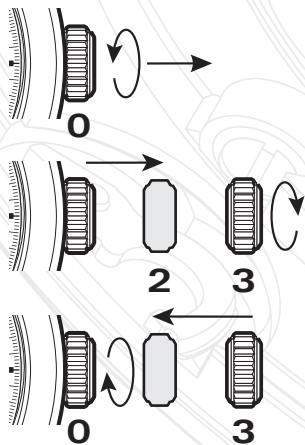

- \* Take a.m./p.m. into consideration when setting the hour and minute hands to the desired time.
- \* Always be certain that your crown is **SECURELY SCREWED**; this will prevent moisture from entering in.

## F) DATE SETTING

1. Unscrew the crown and pull it out to position [2]-(1st click).
2. Turn the crown clockwise to set the correct date.
3. Push the crown in then screw it securely.

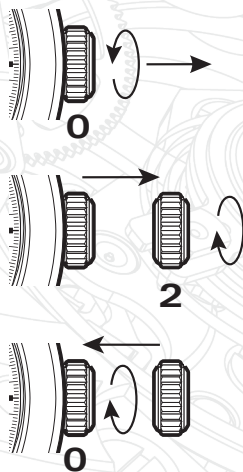

\* Do not set the date between 9:00 P.M. and 4:00 A.M.

## G) HOW TO USE A DUAL DEPLOYANT CLASP

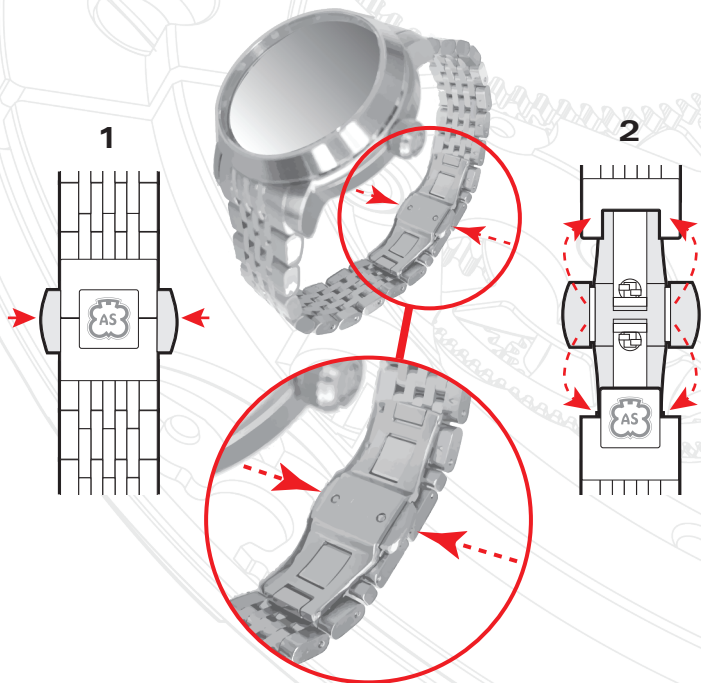

1. Press the buttons on both sides of the clasp.
2. The Buckle will release and open.

# H) HOW TO CHANGE THE BRACELET TO STRAP

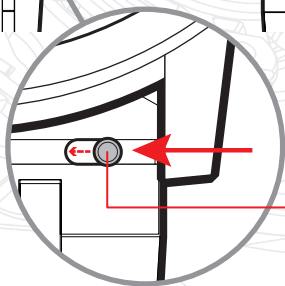
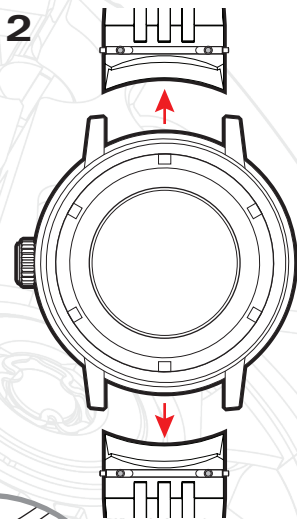
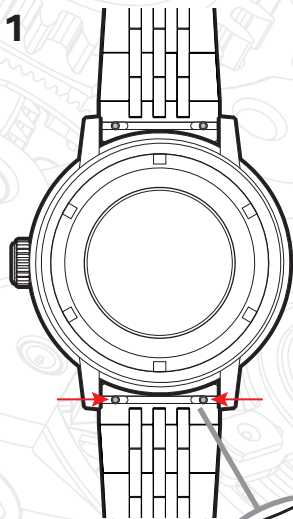

Quick  
Release  
Spring Bar

3

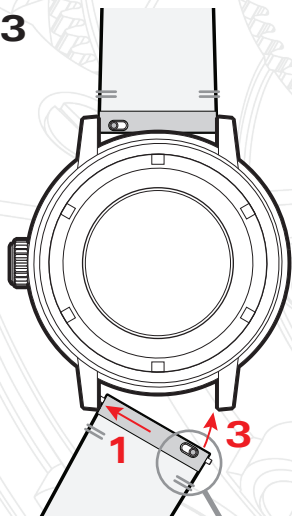

4

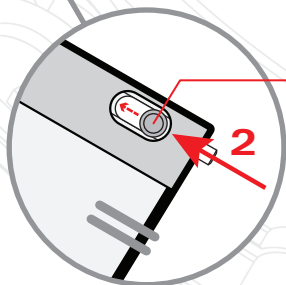
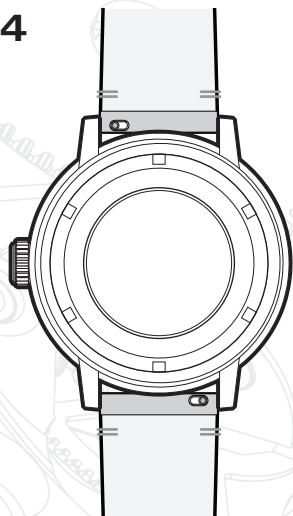

Quick  
Release  
Spring Bar

# CARE & MAINTENANCE

Each **SCHILD** timepiece is designed and manufactured to exceed the highest of standards. In order to ensure optimal performance and longevity from your timepiece, please review the simple guidelines for care and maintenance of your new **SCHILD** timepiece.

Your timepiece should be cleaned with a soft cloth and water only. Do not submerge your timepiece. Your timepiece should be rinsed clean and dried with a soft cloth after any saltwater use.

We advise having your timepiece serviced every 3 or 4 years to ensure long use and trouble free operation.

While your **SCHILD** timepiece has been designed and built to exacting specification, it is important to avoid the following conditions: extreme heat or cold, as well as prolonged periods of exposure to direct sunlight, exposure to wet conditions that exceed your timepiece's water rating (see case back).

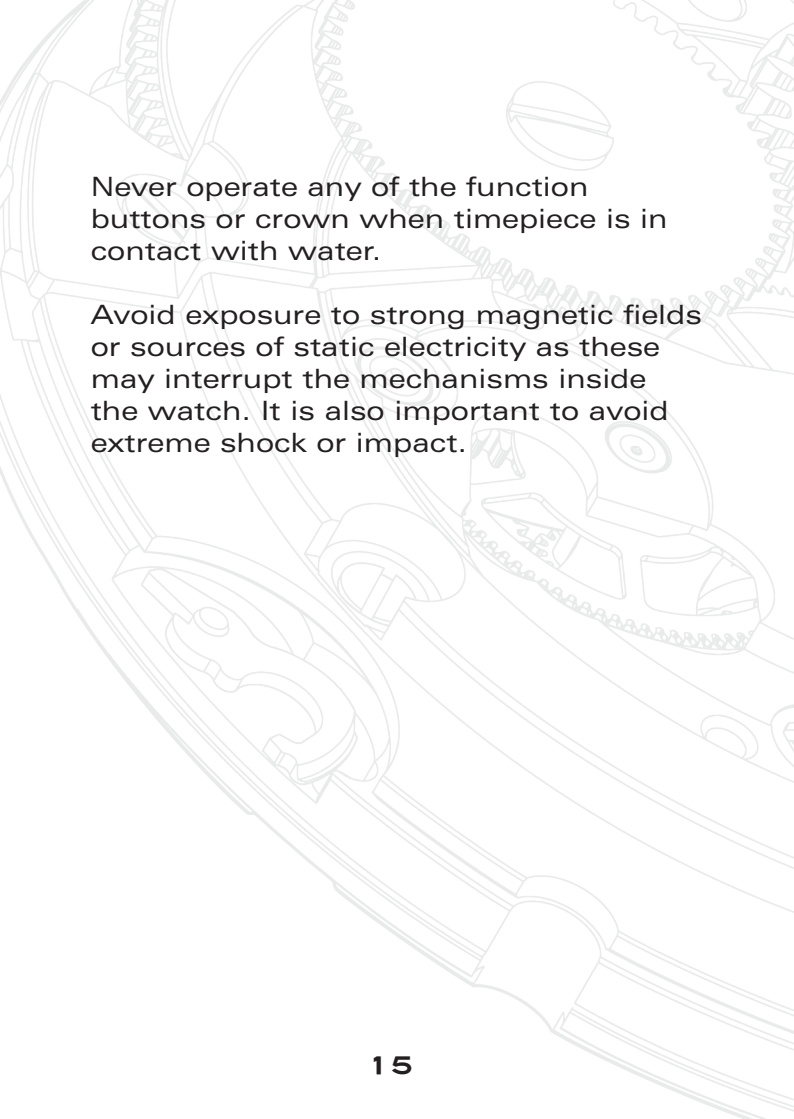

Never operate any of the function buttons or crown when timepiece is in contact with water.

Avoid exposure to strong magnetic fields or sources of static electricity as these may interrupt the mechanisms inside the watch. It is also important to avoid extreme shock or impact.



# WATER RESISTANCE

The water resistance indicated on your timepiece serves only as a guide.

Actual water resistance may vary depending on a number of important factors including temperature, water salinity, and actual use under water.

The water resistance of your timepiece may eventually be compromised over time with general wear and tear and the use of your watch under adverse conditions.

Note that you should NEVER wear your watch in a jacuzzi, hot shower or steam room where steam may enter the case despite the watertight seals used to protect your watch.

The steam may cause condensation inside your watch, which may affect and damage the inner workings of your watch – which would also not be covered by the warranty.

# SERVICE LOG

Use this area to record any aftercare of your timepiece.

DATE	NOTES:	LOCATION





SCHILD

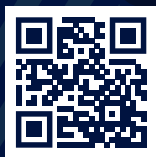

VOL.1.14 EN

[SCHILD1896.COM](http://SCHILD1896.COM)