

Do not scale from this drawing.

The drawing was prepared by AJB Group Ltd. The copyright in the design and drawing belongs to AJB Group Ltd. Duplication of this drawing and the design cannot be made without prior written consent from AJB Group Ltd.

© 2013 AJB Group Ltd

A4

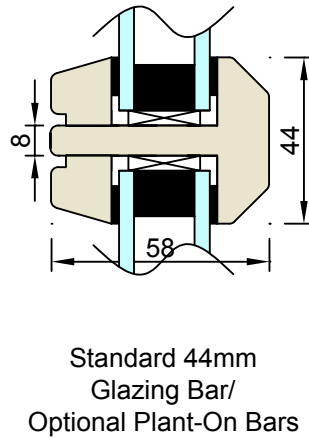
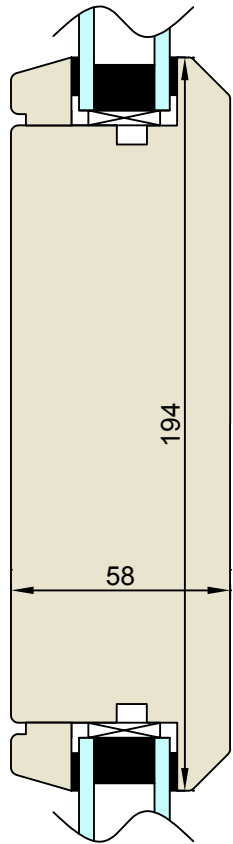
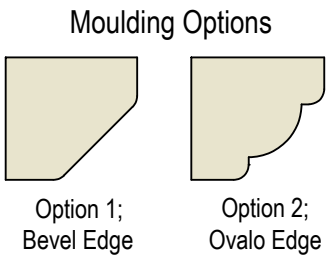
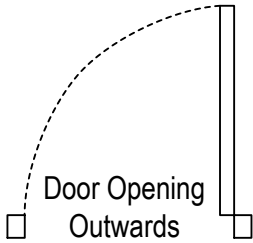
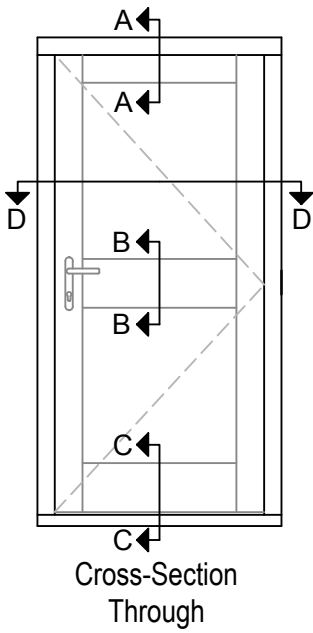

Head Detail Section A-A

Cill Detail Section C-C

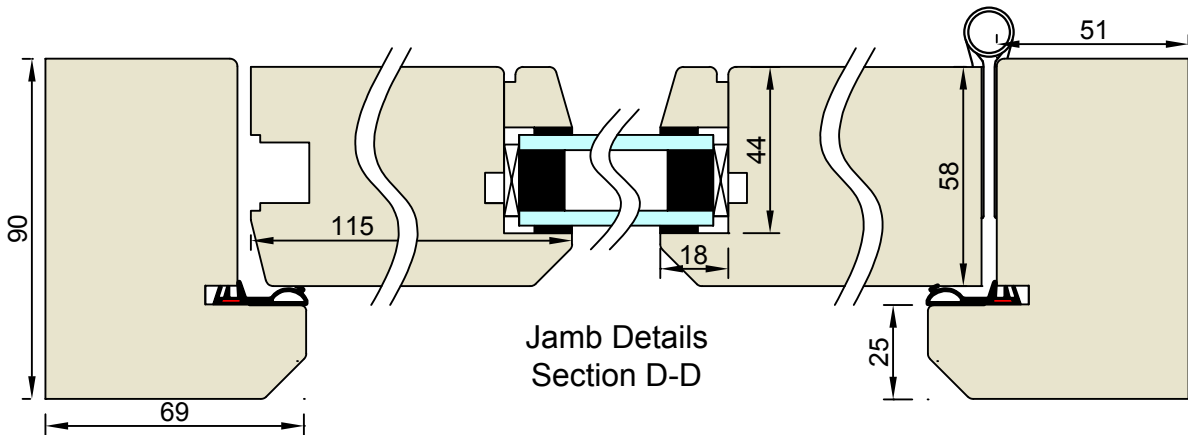
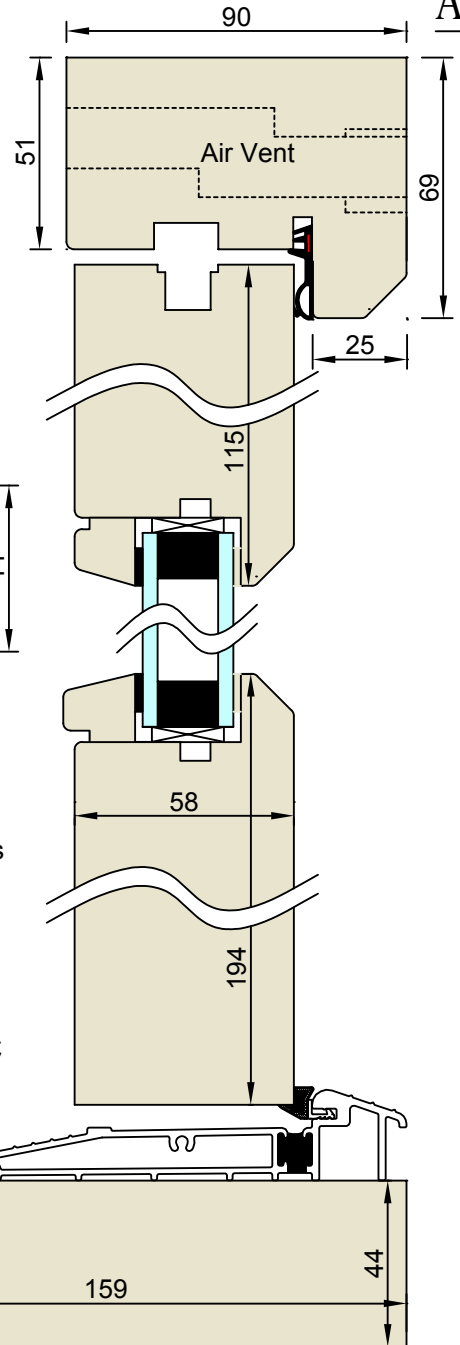

Notes:

Revision	D	C	Date
----------	---	---	------

CLIENT:	PROJECT: Master 90 Opening Out Frame		
ADDRESS:	TITLE: Section Details		
	PURPOSE OF ISSUE: For Review		
SCALE: A4 @ 1:2	D MB	C AM	DATE 01/01/09
JOB NO.:	DRAWING NO. M 02		REVISION /

49 KENILWORTH DR.
OADBY IND ESTATE,
LEICESTER,
LE2 9LT.
TEL: 0116 271 9110
FAX: 0116 271 9098