

Set Up Instructions

WLM-2000E

Step 1: Assemble straight poles by pressing and pushing together.

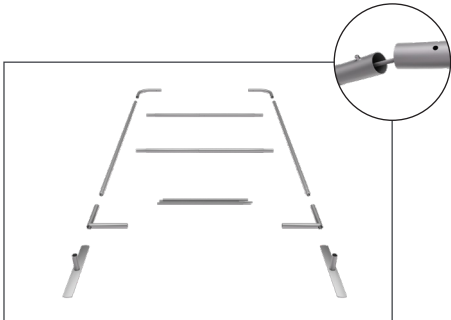

Step 2: Connect all corner sections to curved and straight sections of the frame by matching shape symbols on pipes.

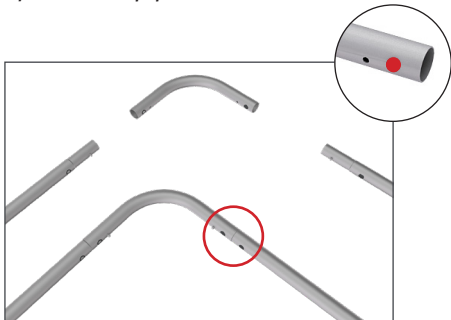

Step 3: Insert feet into base to complete assembled frame shown.

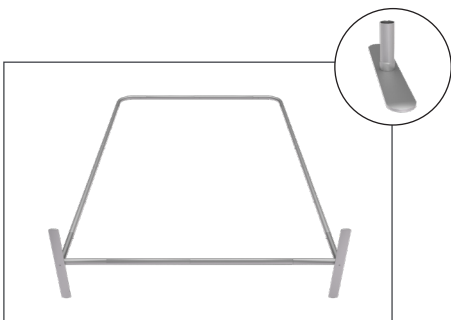

Step 4: Unzip print and lay image face up. Slide print onto frame like a pillow case.

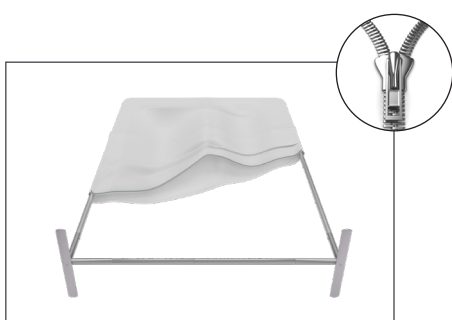

Step 5: Zip the edge of graphic beyond the center point as shown to hold the center pole in place. Zip the remaining side and bottom to meet at the corner.

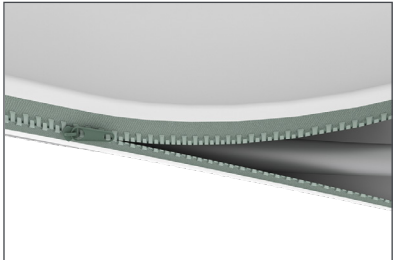

Step 6: Complete.



LIGHTS:
(OPTIONAL) Position as desired and tighten knob to hold in place.
WARNING! Over tightening may cause damage to fabric image.

Set Up Instructions

WLM-2000F

Step 1: Assemble straight poles by pressing and pushing together.

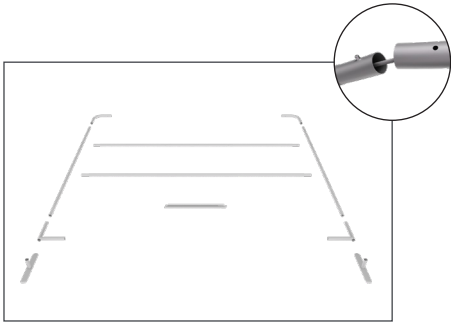

Step 2: Connect all corner sections to curved and straight sections of the frame by matching shape symbols on pipes.

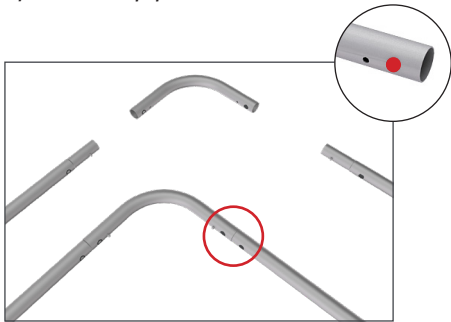

Step 3: Insert center support pole.

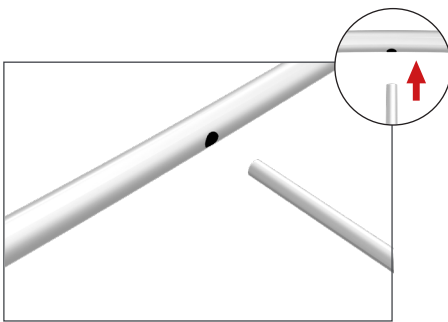

Step 4: Insert feet into base to complete assembled frame shown.

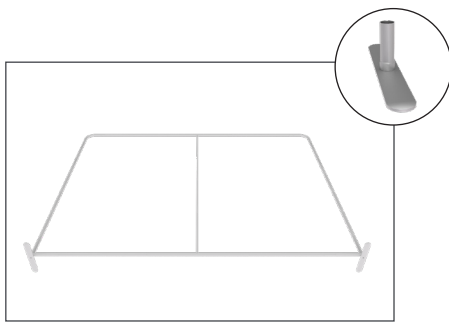

Step 5: Unzip print and lay image face up. Slide print onto frame like a pillow case.

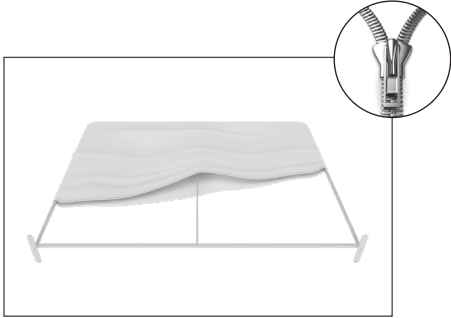

Step 6: Zip the edge of graphic beyond the center point as shown to hold the center pole in place. Zip the remaining side and bottom to meet at the corner.

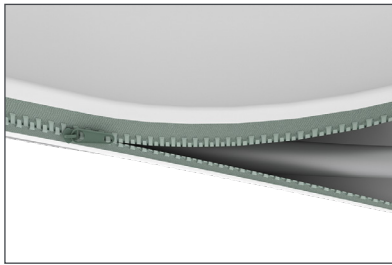

Step 7: Complete.



LIGHTS:
(OPTIONAL) Position as desired and tighten knob to hold in place.
WARNING! Over tightening may cause damage to fabric image.



Set Up Instructions

WLM-2011B

Step 1: Assemble the two long curved and straight sections together. The frame is symmetrical and either of the curved sections can be top or bottom.

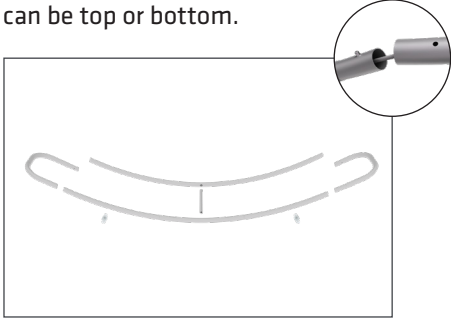

Step 2: Connect all corner sections to curved and straight sections of the frame by matching shape symbols on pipes.

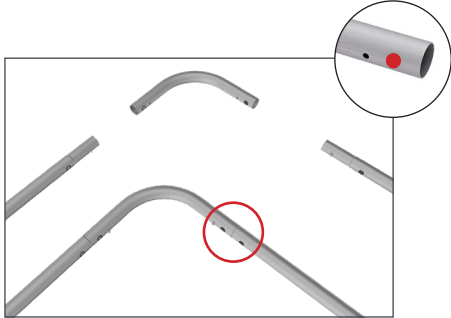

Step 3: Complete assembled frame shown.

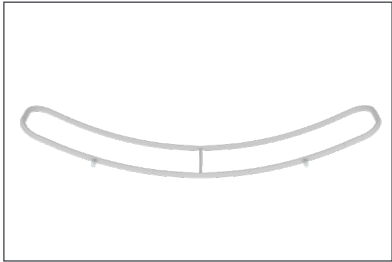

Step 4: Unzip print and lay image face up. Slide print onto frame like a pillow case.

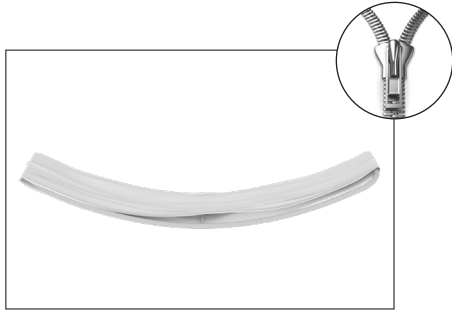

Step 5: Zip the edge of graphic beyond the center point as shown to hold the center pole in place. Zip the remaining side and bottom to meet at the corner.

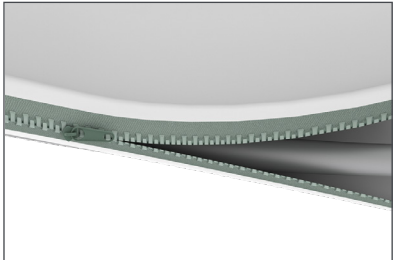

Step 6: Complete.



LIGHTS:
(OPTIONAL) Position as desired and tighten knob to hold in place.
WARNING! Over tightening may cause damage to fabric image.

Set Up Instructions

WLM-PANEL CONNECTION

FEET

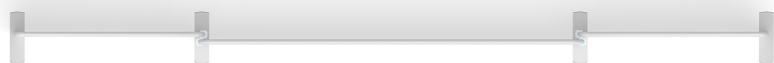
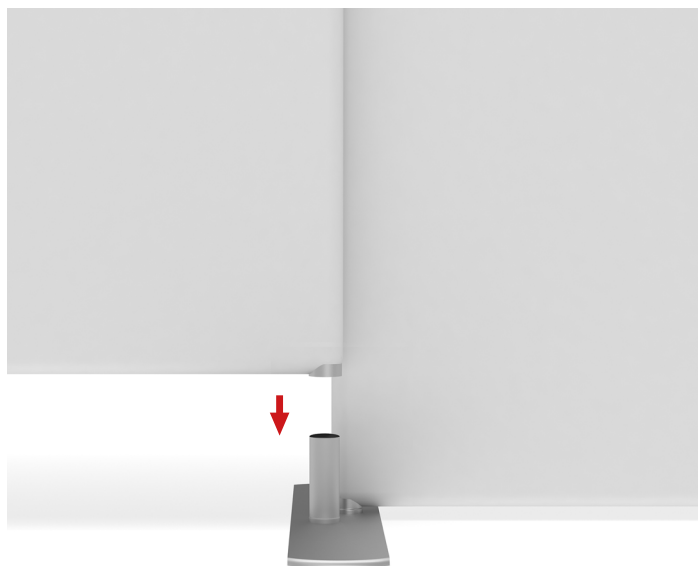

WLM-P-22E



WLM-P-22R



WLM-P-22L

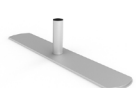

WLM-P-22E

CLAMPS

