

Set Up Instructions

CSNRB-240L

Step 1: Assemble all straight pipes with bungee cords by pushing and pulling together.

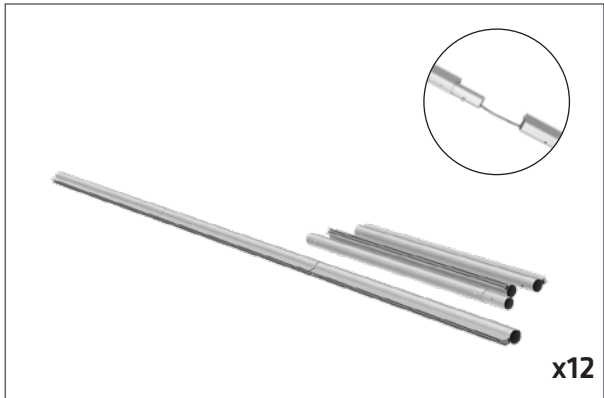

Step 2: Connect all corner sections to straight sections of the frame. Blue pipes represent the vertical pole position and should face up and down.

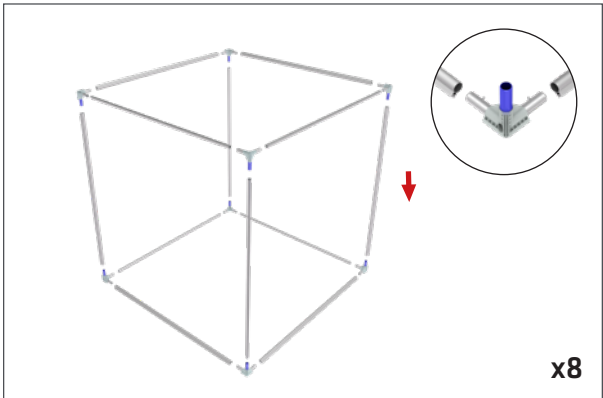

Step 3: At the top of the frame attach cable to opposite corners. Complete task twice to form an X.



Step 4: Move to the center of cable and hand tighten turnbuckle to remove any remaining slack. Do not over tighten.

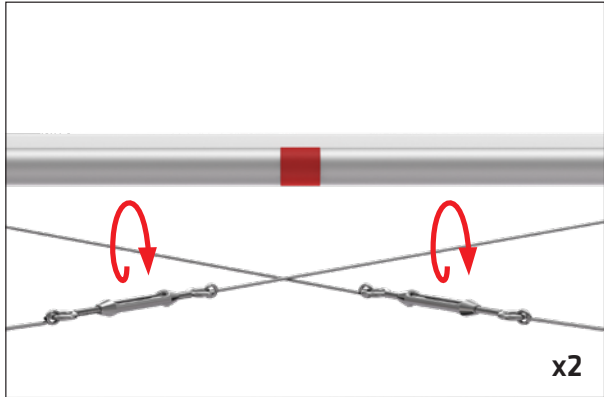

Step 5: Take out the LED Light Arrays and add to cable with power connector on top. The cable blocks can be adjusted by pushing the pin into the block and sliding the block along the cable into desired position.

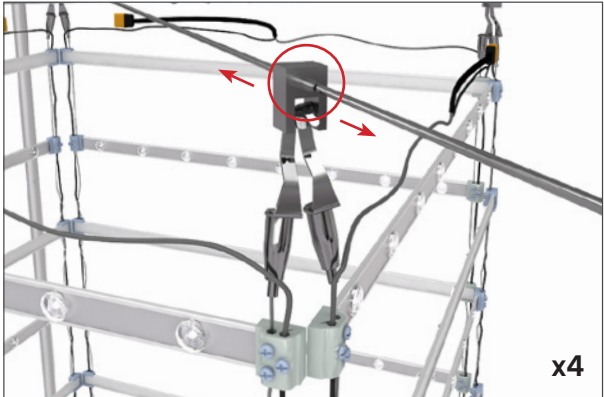
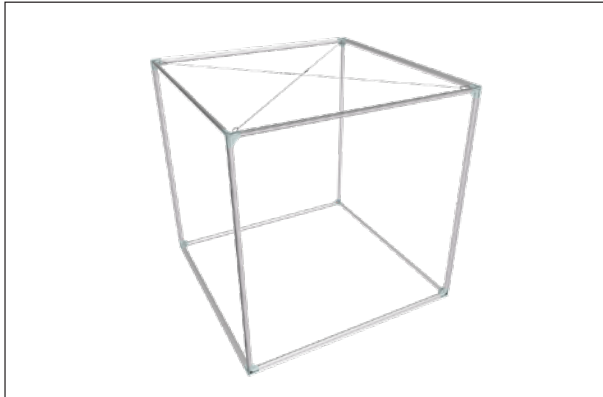

Set Up Instructions

CSNRB-240L

Step 6: Completed vertical LED Light Arrays assembly.

Step 7: Attach bottom horizontal LED Light Array to 4 corners of vertical LED Light Arrays.

Step 8: Attach power cables between bottom and 1 vertical light array. Not all LED Light Arrays need to be plugged in at bottom. 3 plugs will hang freely.

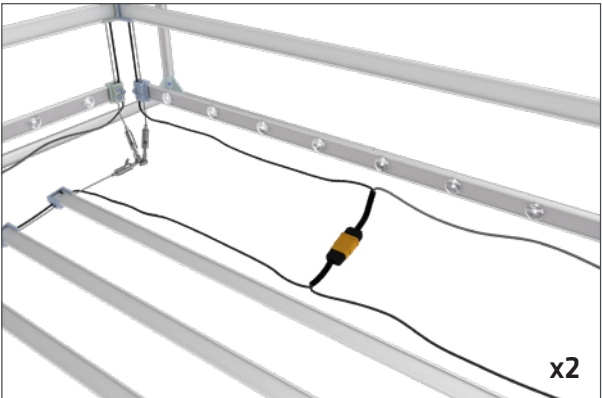
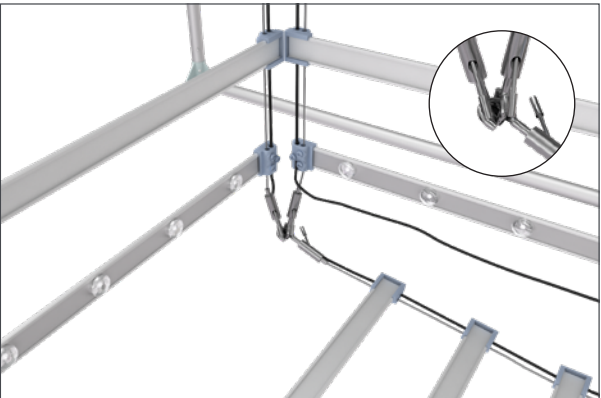

Use drop cloth on ground to prevent graphics from getting dirty!

Step 9: Fold silicone edge graphics over an install into first corner of frame working outwards 4-6 inches. Repeat on remaining corners starting with the opposite corner. Follow the Graphic Diagram.

Step 10: Move to the center of each side of the frame to continue inserting the silicone edge graphics and work back toward the corners.

Graphic Diagram

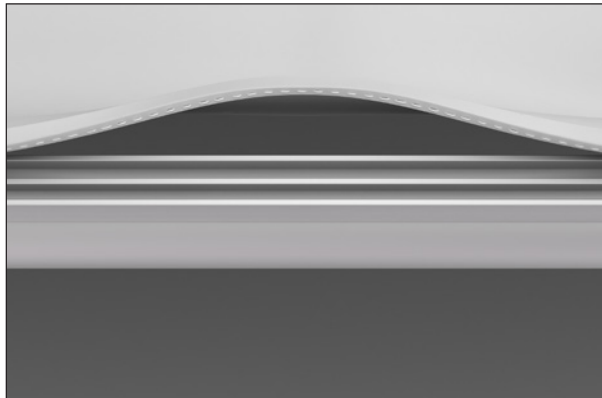
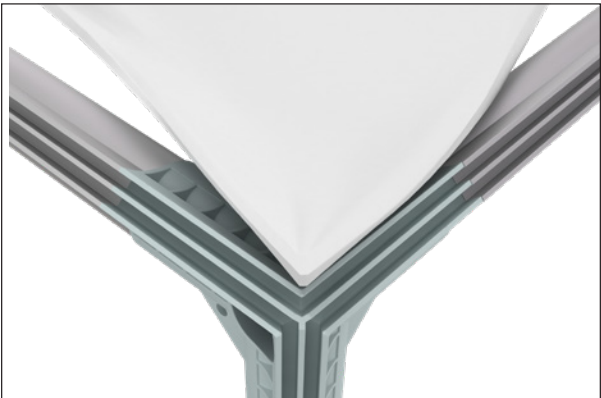
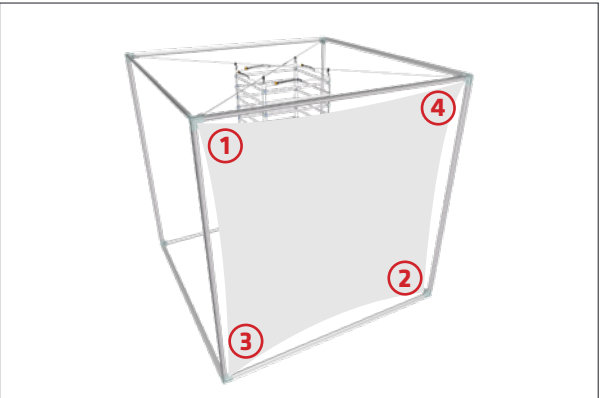

Set Up Instructions

CSNRB-240L

Step 11: Repeat Steps 9-10 on all 4 sides. Leave installation of bottom graphic until after the display has been wired with harness and lifted overhead into a position where it can be installed from the ground.



Step 12: Attach wiring harness to the same carabiners in 4 corners used for the light cables.

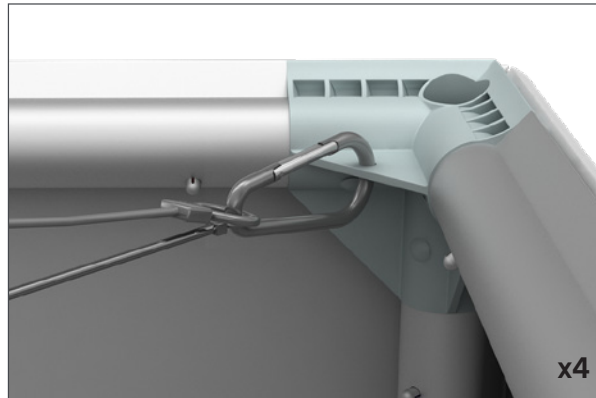

Step 13: Attach power supplies to hanging harness. Plug power supplies to the top of LED Light Arrays. 2 LED Light Arrays per 1 power supply.

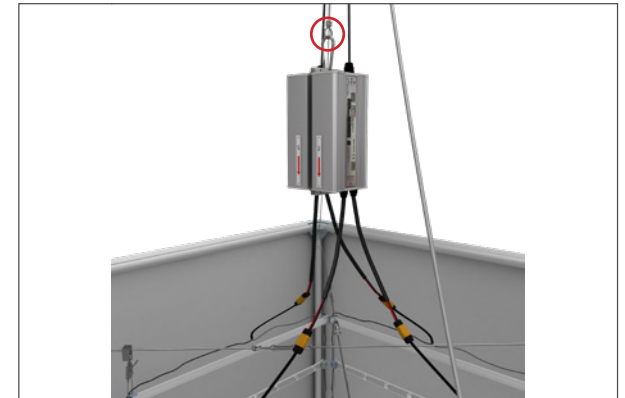

Step 14: Test lights if possible to make sure it has been wired properly.

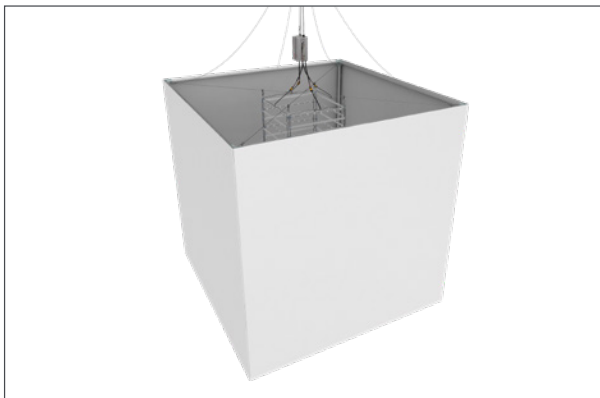

Step 15: Lift display into position and install bottom graphic following Steps 9-10.

