

WaveLine InfoDesk Counter 8J

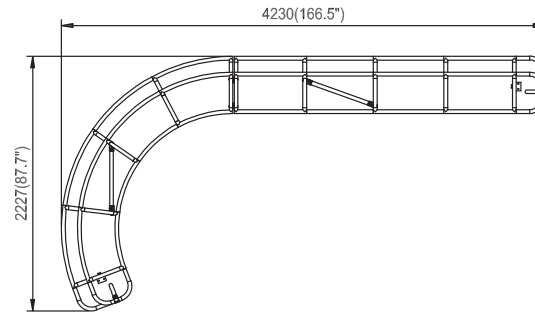
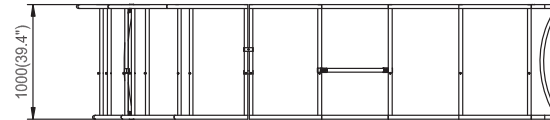
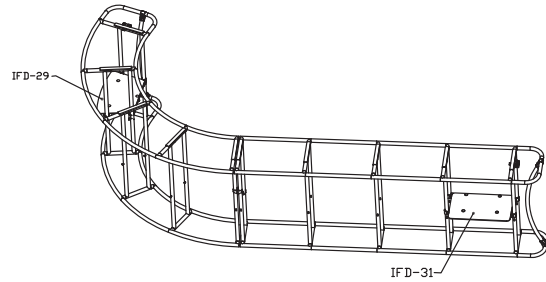
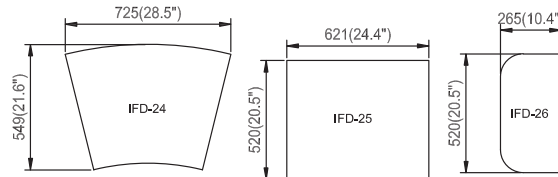
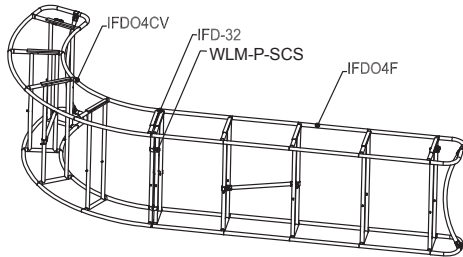

Hardware												Countertop			Graphics		Accessories				Shipping Case		
No.	Quantity	Confirm	No.	Quantity	Confirm	No.	Quantity	Confirm	No.	Quantity	Confirm	No.	Quantity	Confirm		Confirm	No.	Quantity	Confirm	No.	Quantity	Confirm	
IFD04CV	1											Yes / No			Single or Double-sided		IFD-29	1			CA900		
IFD04F	1											IFD-24	4			None		IFD-31	1			CA500	
WLM-P-SCS	2											IFD-25	4			Complete						NYLON BAG	
IFD-32	4											IFD-26	2			Split-ship							

Set Up Instructions

WaveLine InfoDesk Counter 8J

FRAME ASSEMBLY:

Assemble base parts and poles by pressing and pushing together.

*NOT ALL PARTS WILL BE USED:

This counter is made from x3 full kits and not all parts will be needed to complete this design.

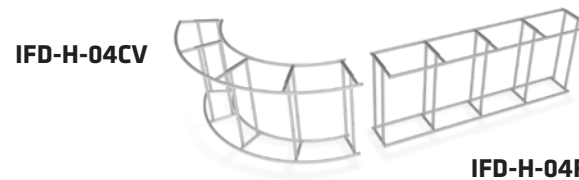
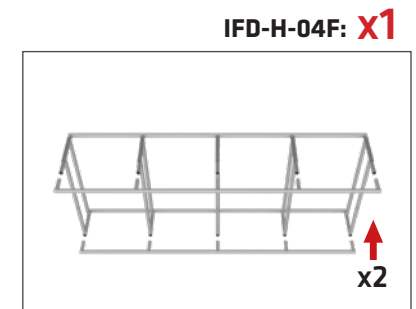
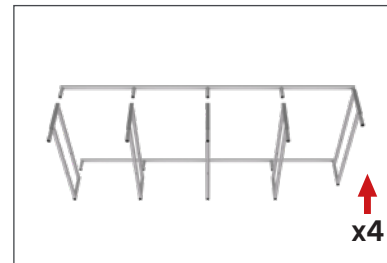
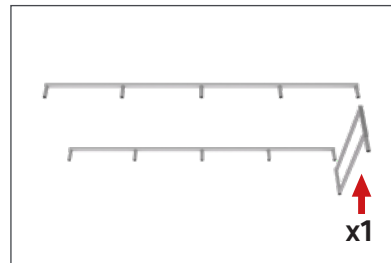
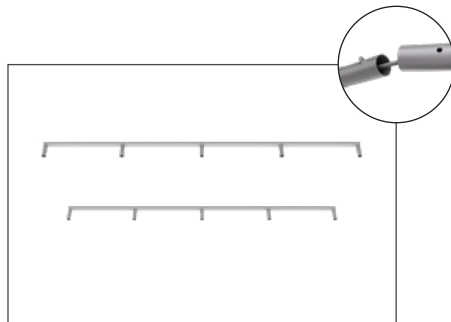
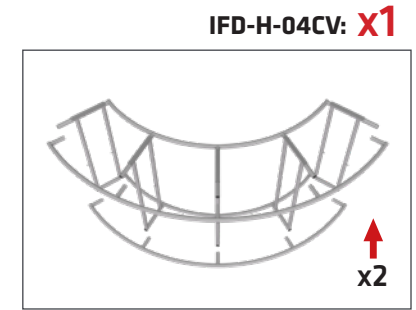
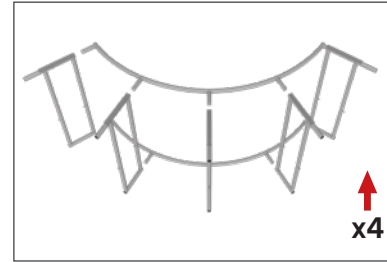
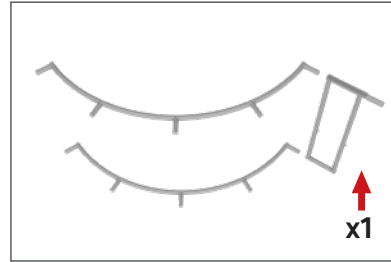
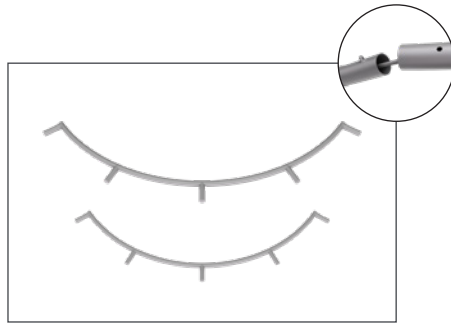

Set Up Instructions

WaveLine InfoDesk Counter 8J

IFD-H-04CV:

Assemble end cap on right side only. Use hand tool when shown.

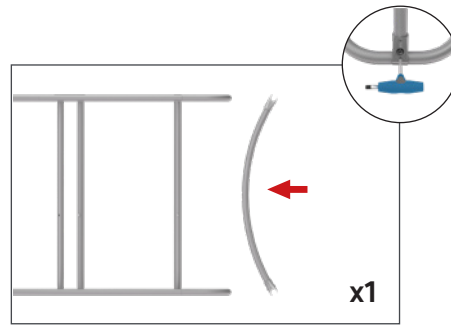
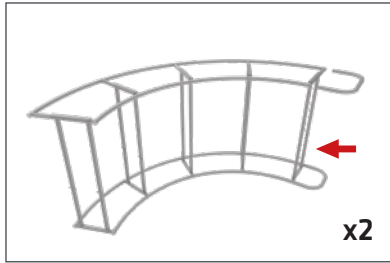

CROSSBAR SUPPORT:

Attach across second opening from the right.

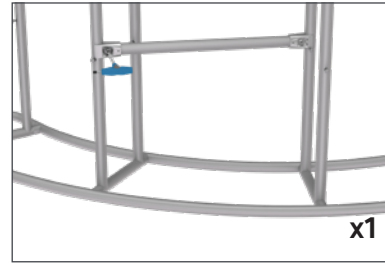

COUNTER TOP SUPPORT:

For leveling end cap counter top.



IFD-H-04F:

Assemble x1 end cap on left side only. Use hand tool when shown.

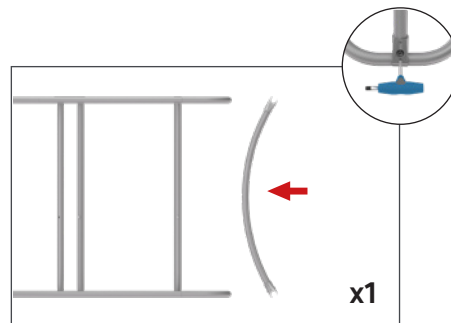
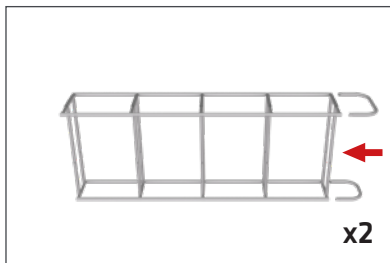

CROSSBAR SUPPORT:

Attach across second opening from the left.

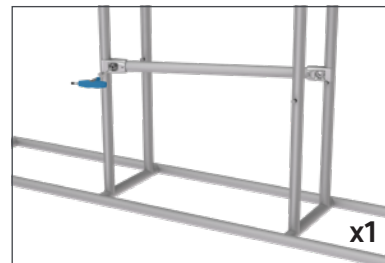

COUNTER TOP SUPPORT:

For leveling end cap counter top.



IFD-H-04CV

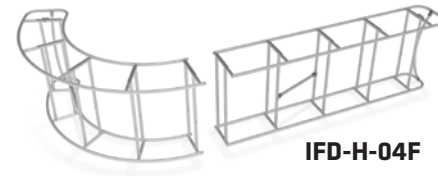

IFD-H-04F

Set Up Instructions

WaveLine InfoDesk Counter 8J

CONNECT FRAMES TOGETHER:
Connect x3 frames together with x2 butterfly clips (WLM-P-SCS) per

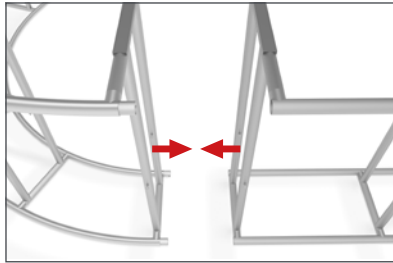

frame connection. Attach one clip to outside of frames and one clip to inside of frame using hand tool.

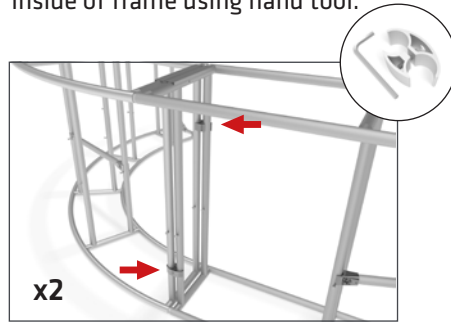

WLM-P-SCS

SHELVES:
(OPTIONAL) To add shelves to frame, position and level shelf on

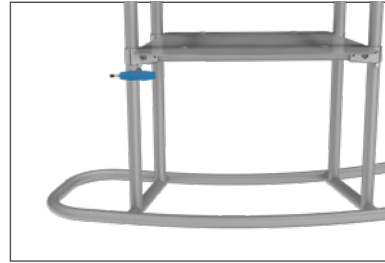

frame before tightening clamps down with hex tool.

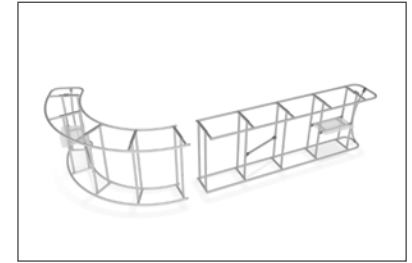

GRAPHIC INSTALL:
Step 1: Unzip print and slide print onto frame like a pillow case.

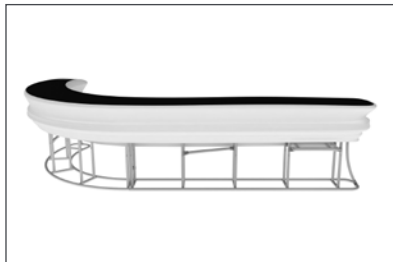

Step 2: Grip the fabric tightly and stretch around bottom of desk to pinch zipper into place. Zip the print together for taut finish.

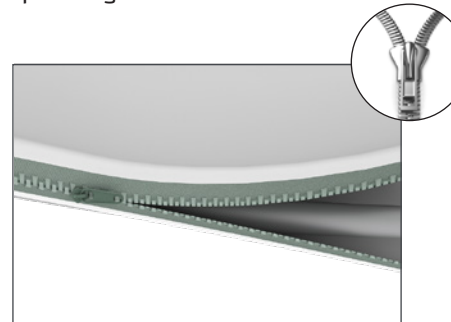

Step 3: Attach countertop panels to fabric counter with Velcro. Start at one end and work your way across to the other side.

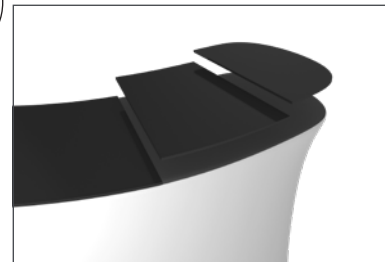

Step 4: Join counter top panels together front and back with black push-on clamps.

