



# Set Up Instructions

# WaveLine InfoDesk Counter 12J

### FRAME ASSEMBLY:

Assemble base parts and poles by pressing and pushing together.

### \*NOT ALL PARTS WILL BE USED:

This counter is made from x3 full kits and not all parts will be needed to complete this design.

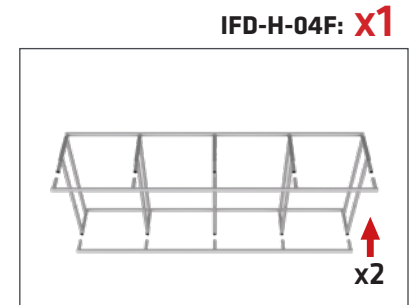
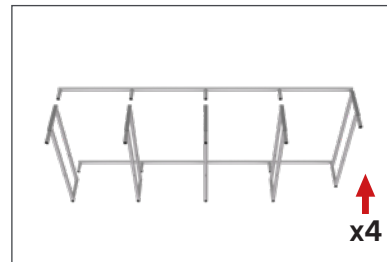
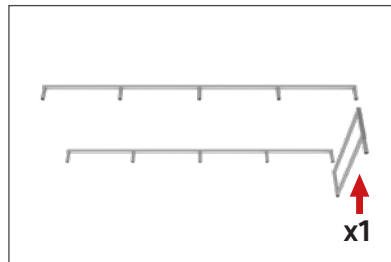
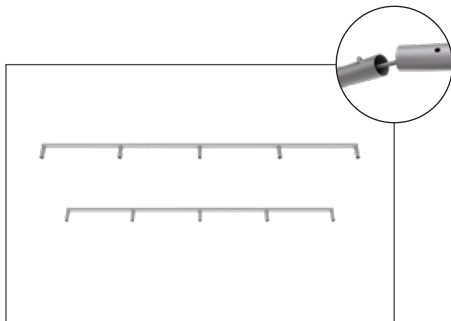
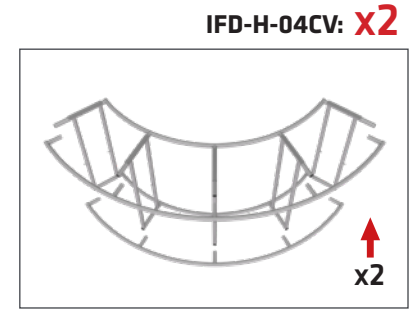
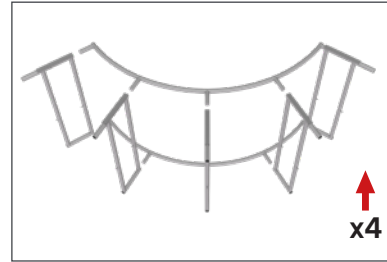
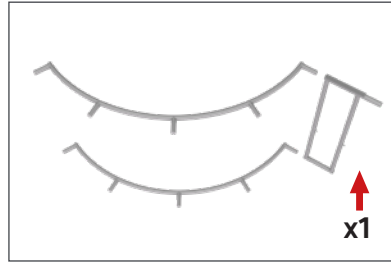
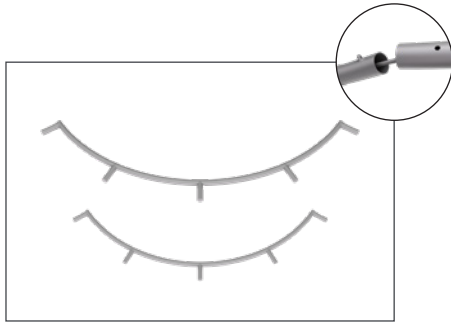

IFD-H-04CV Back

IFD-H-04CV Front

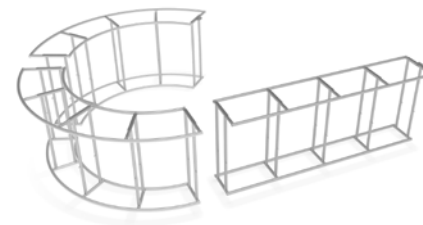

IFD-H-04F

# Set Up Instructions

# WaveLine InfoDesk Counter 12j

### IFD-H-04CV Back:

Assemble end cap on left side only.  
Use hand tool when shown.

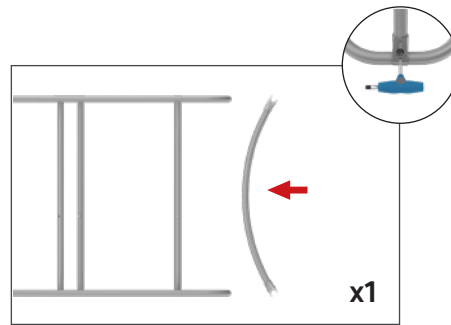
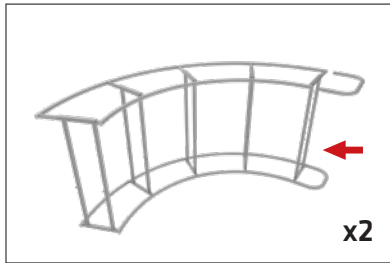

### CROSSBAR SUPPORT:

Attach across second opening from the left.

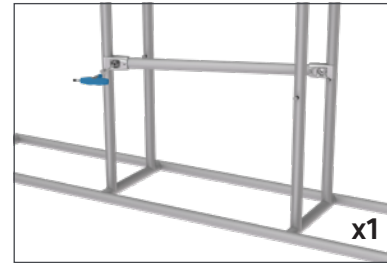

### COUNTER TOP SUPPORT:

For leveling end cap counter top.

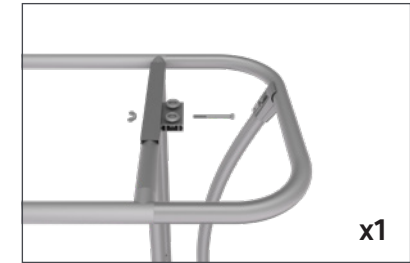

### IFD-H-04F:

Assemble end cap on left side only.  
Use hand tool when shown.

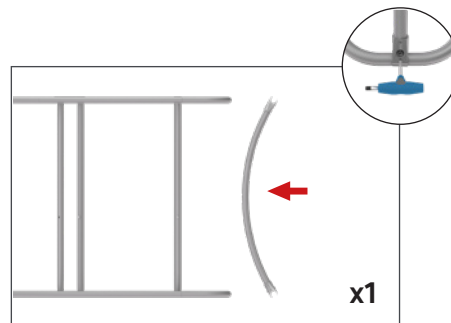
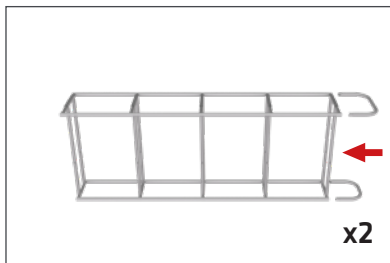

### CROSSBAR SUPPORT:

Attach across second opening from the left.

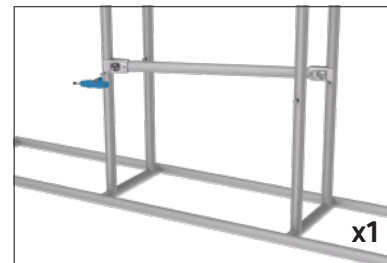

### COUNTER TOP SUPPORT:

For leveling end cap counter top.



### IFD-H-04F Front:

Do not assemble end caps for  
IFD-H-04CV Front counter.

Assemble crossbar support for  
IFD-H-04F Front counter.

IFD-H-04CV Back

IFD-H-04CV Front

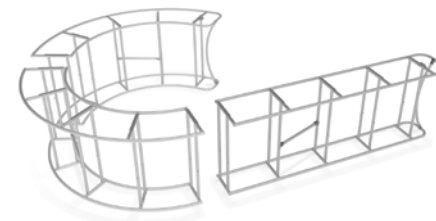

IFD-H-04F

# Set Up Instructions

# WaveLine InfoDesk Counter 12J

**CONNECT FRAMES TOGETHER:**  
Connect x3 frames together with x2 butterfly clips (WLM-P-SCS) per

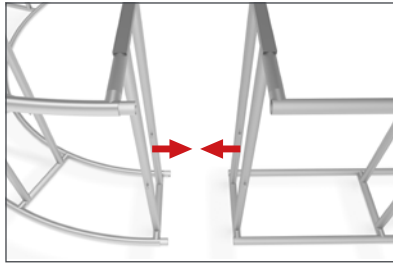

frame connection. Attach one clip to outside of frames and one clip to inside of frame using hand tool.

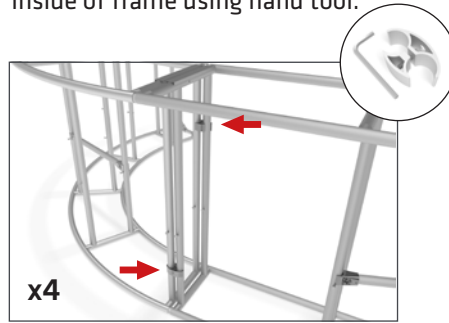

WLM-P-SCS

**SHELVES:**  
(OPTIONAL) To add shelves to frame, position and level shelf on



frame before tightening clamps down with hex tool.

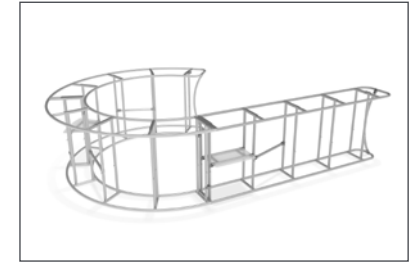

**GRAPHIC INSTALL:**  
**Step 1:** Unzip print and slide print onto frame like a pillow case.

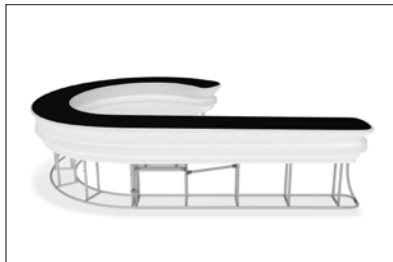

**Step 2:** Grip the fabric tightly and stretch around bottom of desk to pinch zipper into place. Zip the print together for taut finish.

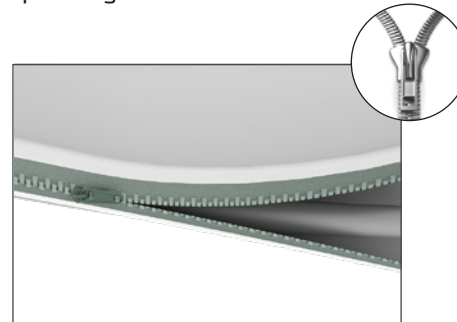

**Step 3:** Attach countertop panels to fabric counter with Velcro. Start at one end and work your way across to the other side.

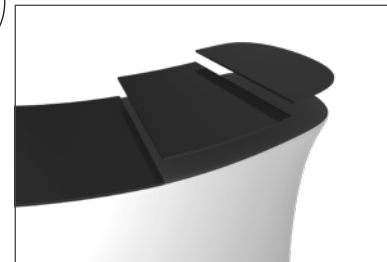

**Step 4:** Join counter top panels together front and back with black push-on clamps.

