

Set Up Instructions

WaveLine InfoDesk Counter 12CC

FRAME ASSEMBLY:

Assemble base parts and poles by pressing and pushing together.

*NOT ALL PARTS WILL BE USED:

This counter is made from x3 full kits and not all parts will be needed to complete this design.

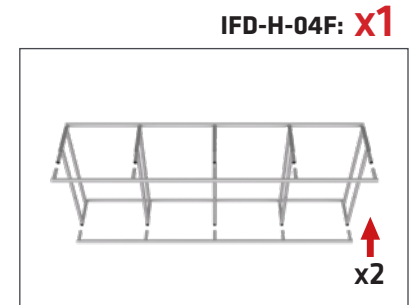
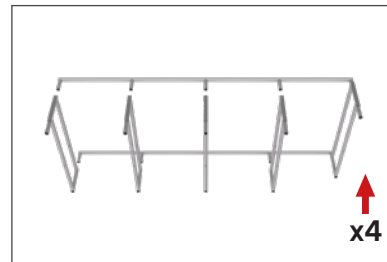
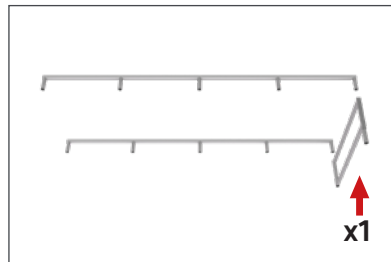
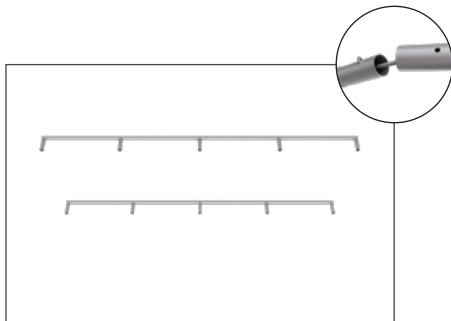
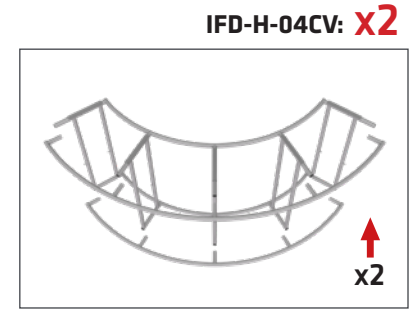
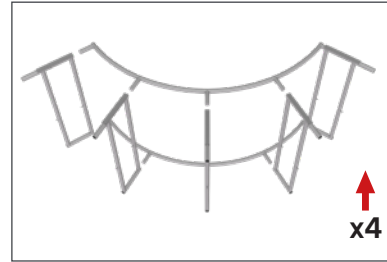
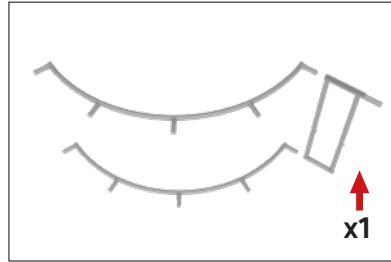
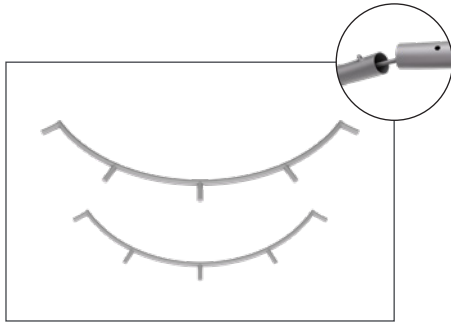

IFD-H-04CV Left

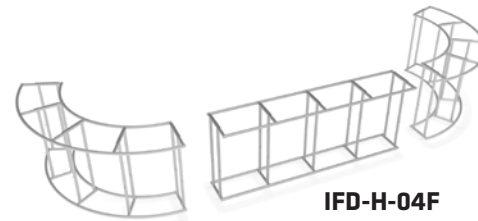

IFD-H-04F

IFD-H-04CV Right

Set Up Instructions

WaveLine InfoDesk Counter 12CC

IFD-H-04CV Right:

Assemble end cap on right side only. Use hand tool when shown.

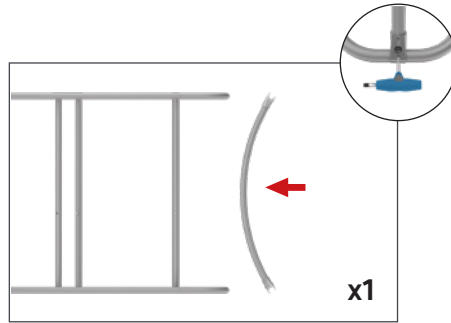
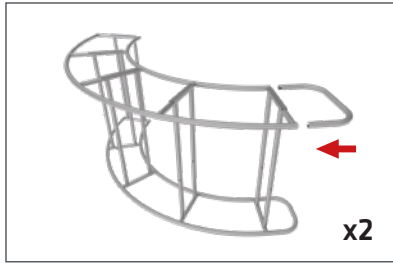

CROSSBAR SUPPORT:

Attach across second opening from the right.



COUNTER TOP SUPPORT:

For leveling end cap counter top.



IFD-H-04CV Left:

Assemble end cap on left side only. Use hand tool when shown.

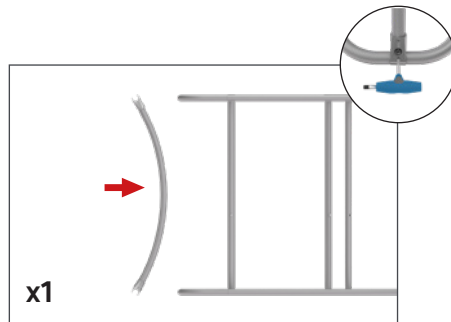
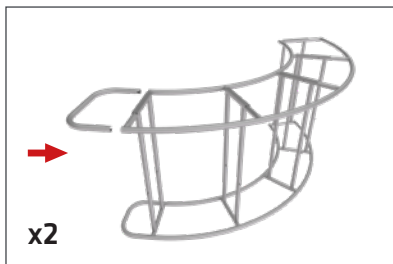

CROSSBAR SUPPORT:

Attach across second opening from the left.



COUNTER TOP SUPPORT:

For leveling end cap counter top.



IFD-H-04F:

Do not assemble end caps for IFD-H-04F center counter.

Assemble crossbar support for IFD-H-04F center counter.

IFD-H-04CV Left

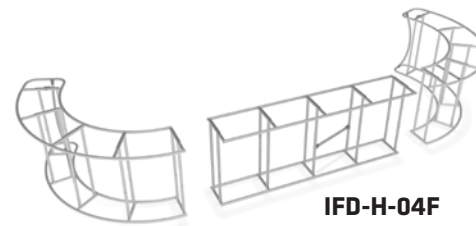

IFD-H-04F

IFD-H-04CV Right

Set Up Instructions

WaveLine InfoDesk Counter 12CC

CONNECT FRAMES TOGETHER:
Connect x3 frames together with x2 butterfly clips (WLM-P-SCS) per

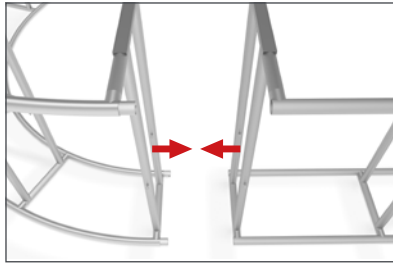

frame connection. Attach one clip to outside of frames and one clip to inside of frame using hand tool.

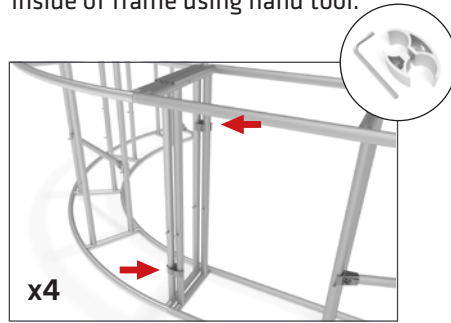

WLM-P-SCS

SHELVES:
(OPTIONAL) To add shelves to frame, position and level shelf on

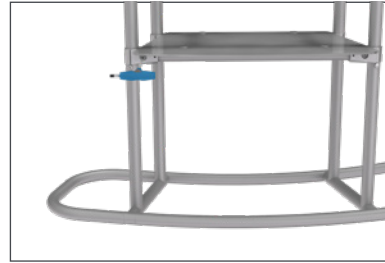

frame before tightening clamps down with hex tool.

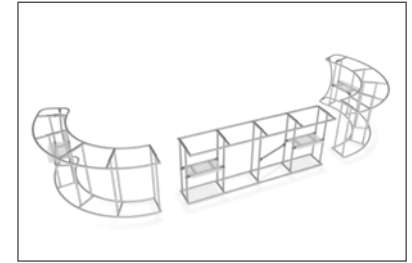

GRAPHIC INSTALL:
Step 1: Unzip print and slide print onto frame like a pillow case.

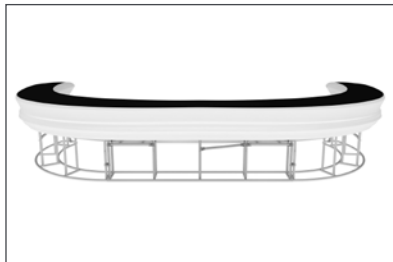

Step 2: Grip the fabric tightly and stretch around bottom of desk to pinch zipper into place. Zip the print together for taut finish.

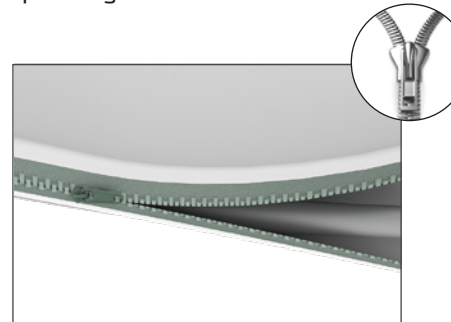

Step 3: Attach countertop panels to fabric counter with Velcro. Start at one end and work your way across to the other side.

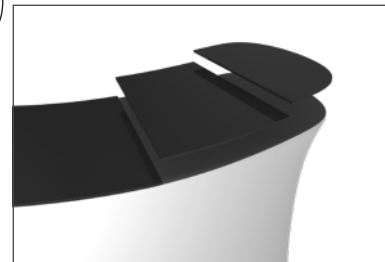

Step 4: Join counter top panels together front and back with black push-on clamps.

