

# WaveLine InfoDesk Counter 05F

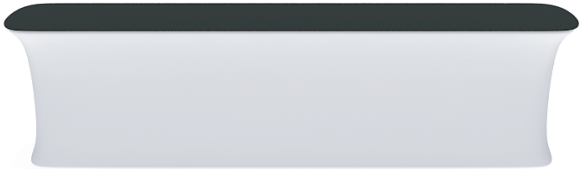
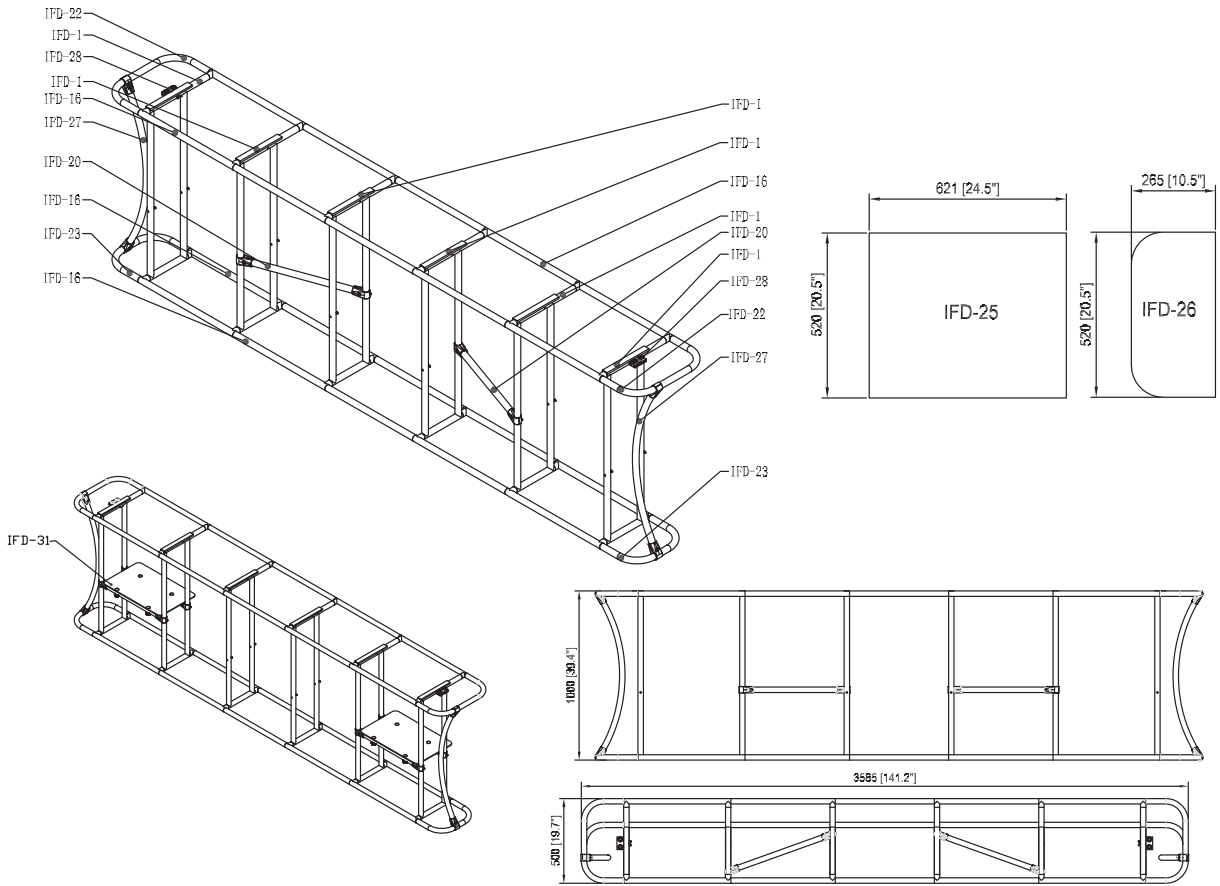

Hardware											Countertop			Graphics		Accessories			Shipping Case			
No.	Quantity	Confirm	No.	Quantity	Confirm	No.	Quantity	Confirm	No.	Quantity	Confirm	No.	Quantity	Confirm		Confirm	No.	Quantity	Confirm	No.	Quantity	Confirm
IFD-1	6		IFD-27	2		/						Yes / No			Single or Double-sided		IFD-31	2		CA900		
IFD-16	4		IFD-28	2								IFD-25	5		None				CA500			
IFD-20	2											IFD-26	2		Complete				NYLON BAG			
IFD-22	2													Split-ship								
IFD-23	2																					

# Set Up Instructions

# WaveLine InfoDesk Counter 05F

**Step 1:** Assemble base parts and poles by pressing and pushing together. Use hand tool when shown.

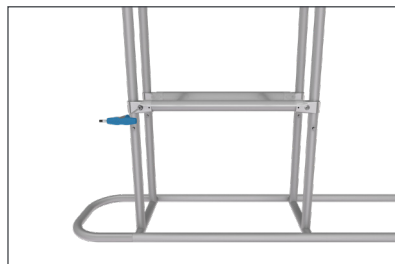
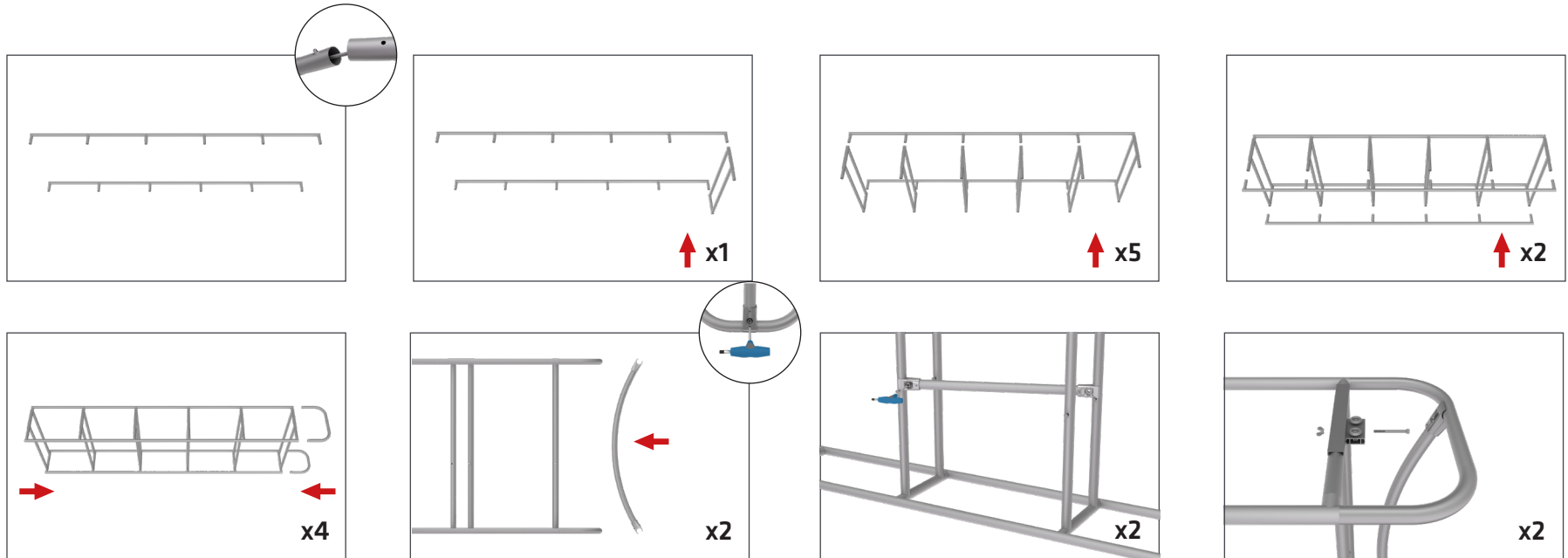

**SHELVES:**  
(OPTIONAL) To add shelves to frame, position and level shelf on frame before tightening clamps down with hex tool.

\*Shelves will only fit on the two outermost interior frame sections.

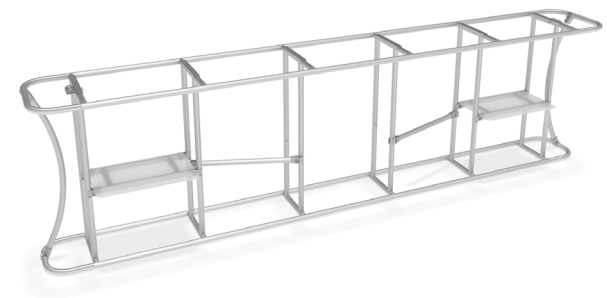

# Set Up Instructions

# WaveLine InfoDesk Counter 05F

**Step 1:** Unzip print and slide print onto frame like a pillow case.

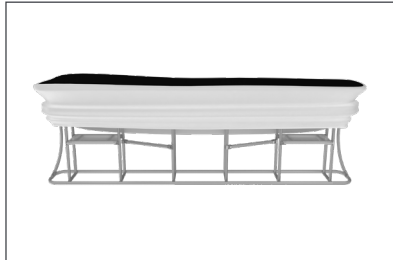

**Step 2:** Grip the fabric tightly and stretch around bottom of desk to pinch zipper into place. Zip the print together for taut finish.

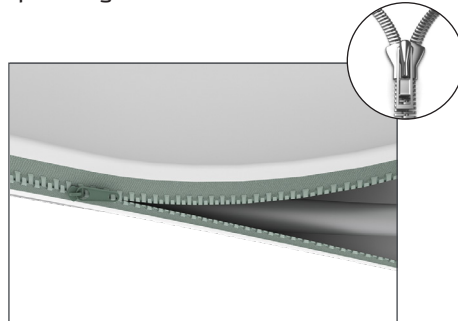

**Step 3:** Attach countertop panels to fabric counter with Velcro. Start at one end and work your way across to the other side.

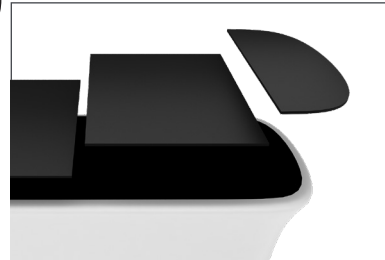

**Step 4:** Join counter top panels together front and back with black push-on clamps.

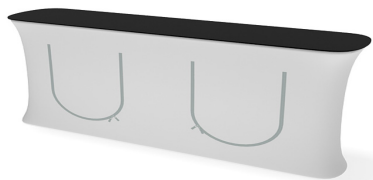
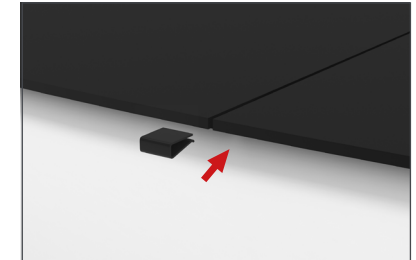

**STORAGE ZIPPER:**  
(OPTIONAL) Zipper access to shelving and storage.

