

# Set Up Instructions

# WaveLine Display Panel 2000F

**Step 1:** Assemble straight poles by pressing and pushing together.

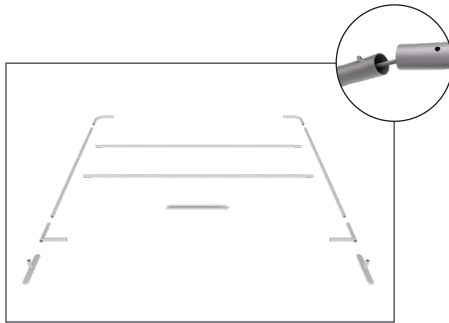

**Step 2:** Connect all corner sections to curved and straight sections of the frame by matching shape symbols on pipes.

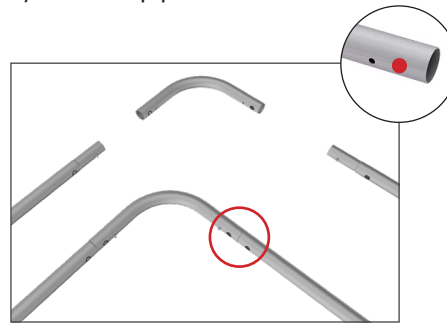

**Step 3:** Insert center support pole.

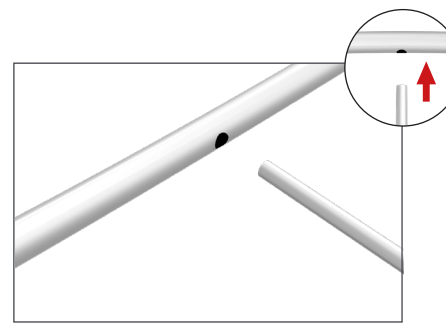

**Step 4:** Insert feet into base to complete assembled frame shown.

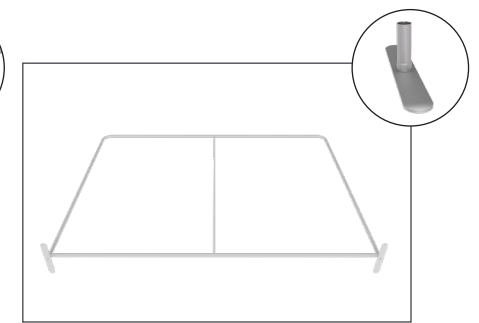

**Step 5:** Unzip print and lay image face up. Slide print onto frame like a pillow case.

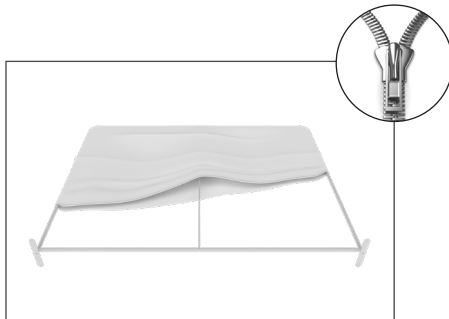

**Step 6:** Zip the edge of graphic beyond the center point as shown to hold the center pole in place. Zip the remaining side and bottom to meet at the corner.

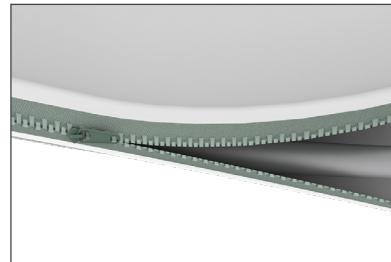

**Step 7:** Complete.



**LIGHTS:**  
(OPTIONAL) Position as desired and tighten knob to hold in place.  
**WARNING! Over tightening may cause damage to fabric image.**



# Set Up Instructions

# WLM-PANEL CONNECTION

## FEET

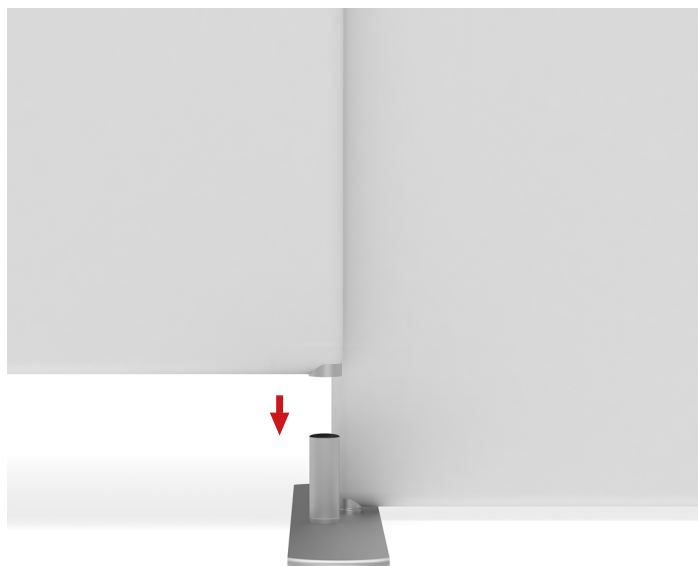

WLM-P-22E



WLM-P-22R



WLM-P-22L

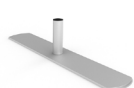

WLM-P-22E

## CLAMPS

