

# Set Up Instructions

# WLT-73R

**Step 1:** Connect poles by pressing and pushing together, then connect corner sections to straight sections with matching shape symbols.

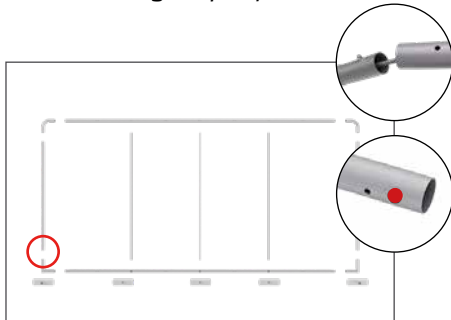

**Step 2:** Take out the LED Lights and **gently** unroll on the ground with lights face down. **WARNING! Do not drag lights across ground or it could break the LED lights.**

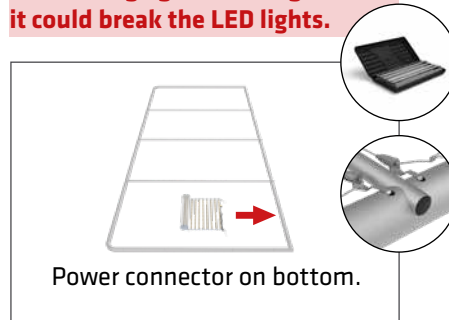

Power connector on bottom.

**Step 3:** Attach each LED Light Array to top and bottom of frame.

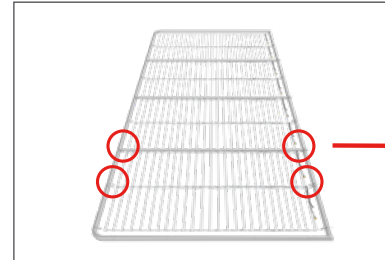

Pull extra cable leash at bottom to secure each LED Light Array into place.

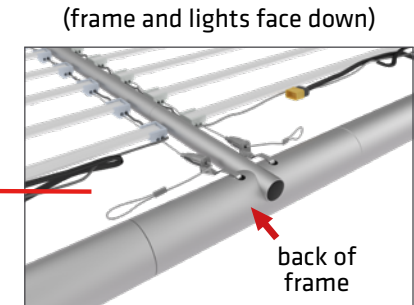

**Step 4:** Unzip print and lay image face down. Slide print onto the frame like a pillow case.

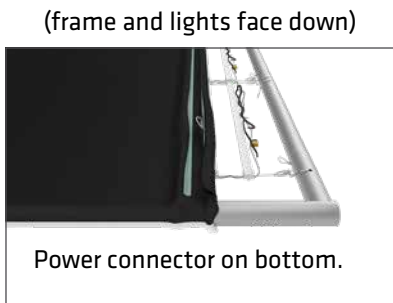

**Step 5:** Unzip pocket on black fabric for more stretch. Pull graphic over bottom edge and pinch zipper to together to zip closed.

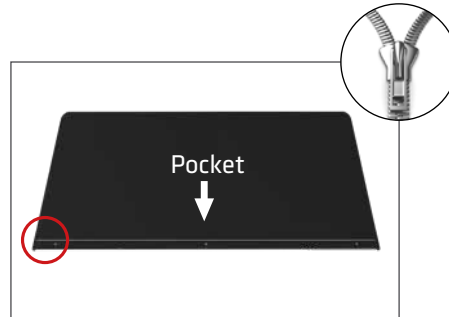

**Step 6:** Connect the feet by inserting into the bottom holes of frame and pressing firmly. Lift frame into upright position.

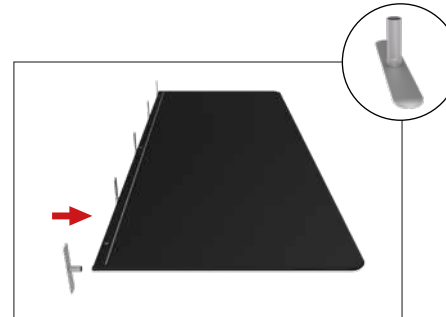

**Step 7:** Find cable ends and pull through grommet holes. Connect each power cable to a power supply. **WARNING! Only connect one light array to each power supply.**

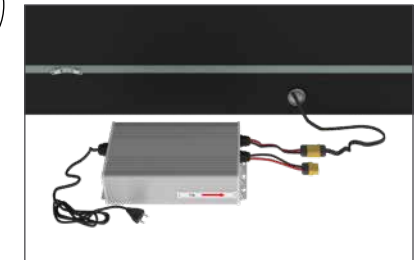

**Step 8:** Collect cables together and close zipper. Plug power supply into electrical unit and turn on to complete.



**NOTE: If you can see the lights and the print is not evenly diffused:**

1. Check that the display is level and not leaning forward.
2. The graphic is fully zipped on bottom and under tension.

3. The lights are hooked to the back of frame and the printing is on the opposite front side of frame.

4. Make sure light array has been fully tensioned with the extra cable leash (Step 3) and not loose.