

# Vector Frame Lightbox Square 03

Vector Frame fabric light boxes feature durable 100mm aluminum extrusion frames, push-fit back-lit fabric graphics and LED top and bottom lighting. Single and double-sided graphic options are available. LED lights come adhered to the frame, making set-up as simple as assembling the frame, applying the push-fit graphics and plugging in the electrical cord!



## features and benefits:

- 100mm (4") silver extrusion frame
- LED lighting top & bottom
- Single or double-sided push-fit fabric graphics
- Easy assembly
- Comes packaged with one OCH wheeled molded case for transport and storage
- Lifetime hardware warranty against manufacturer defects

## dimensions:

### Hardware

### Graphic

Assembled unit:  
71.73" w x 71.12" h x 19.7" d  
1822mm(w) x 1806mm(h) x 500mm(d)

Refer to related graphic template for more information.

Approximate weight with case:  
72 lbs / 33 kgs

Visit:  
<https://www.tradeshowplus.com>

### Shipping

## additional information:

Packing case(s):  
1 OCH

Graphic material:  
Backlit Intensity push-fit fabric graphic

Shipping dimensions:  
50" l x 29" h x 12" d  
1270mm(l) x 737mm(h) x 305mm(d)

When included in a larger kit, a different packaging solution will be listed to accommodate all contents of the kit. Individual packaging no longer provided.

Approximate total shipping weight (includes cases & graphics):  
74 lbs / 34 kgs



This product may include the following materials for recycle:  
aluminum, select wood, fabric, cardboard, paper, steel, and plastics.

1 person assembly recommended:



We are continually improving and modifying our product range and reserve the right to vary the specifications without prior notice. All dimensions and weights quoted are approximate and we accept no responsibility for variance. E&OE. See Graphic Templates for graphic bleed specifications.

\*Not to scale

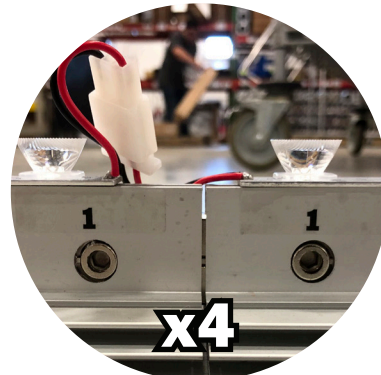
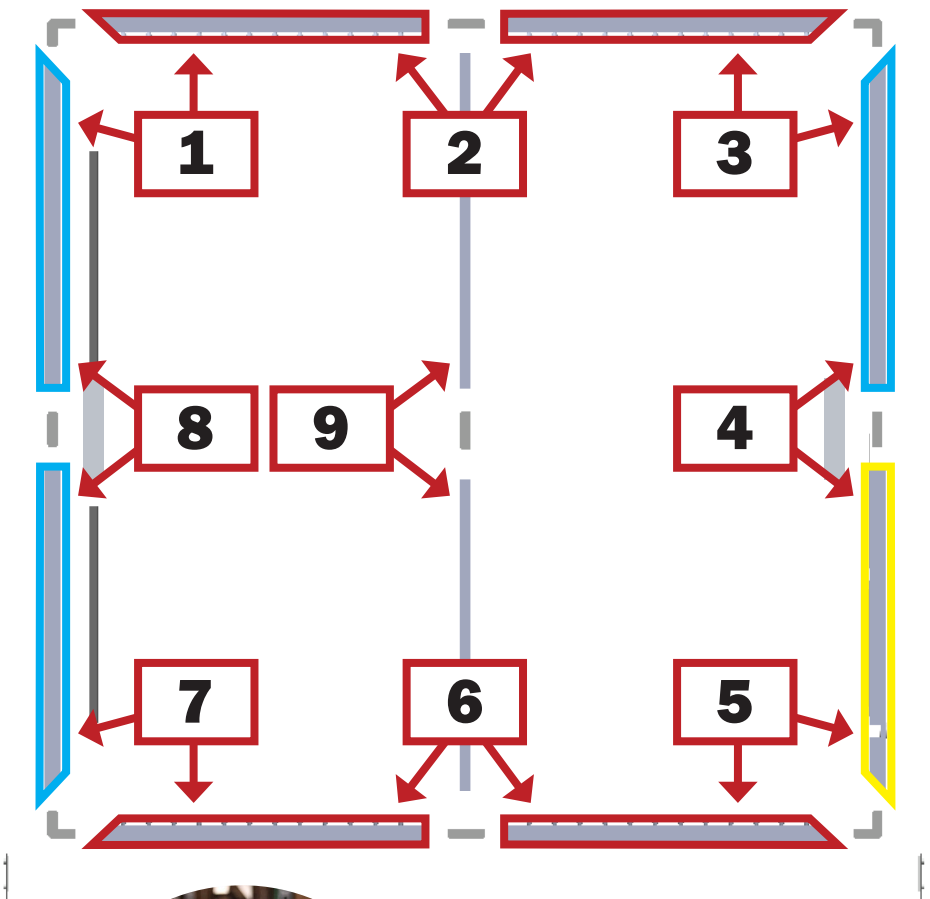
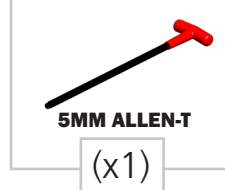
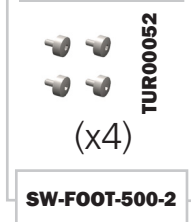
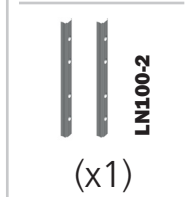
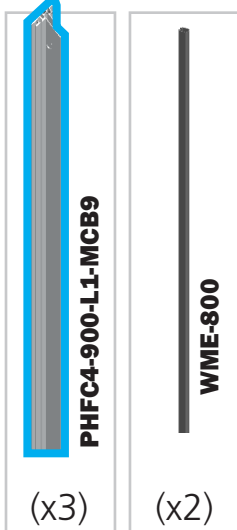
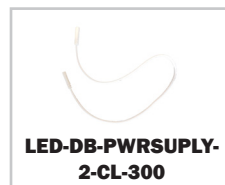
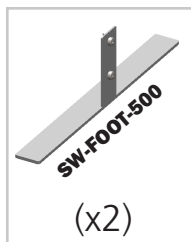
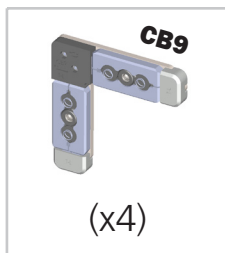
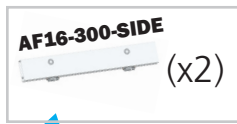
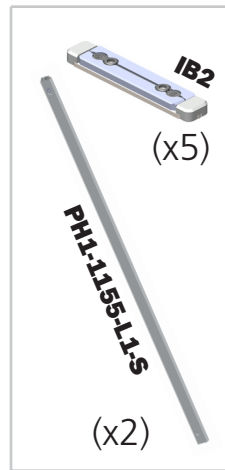
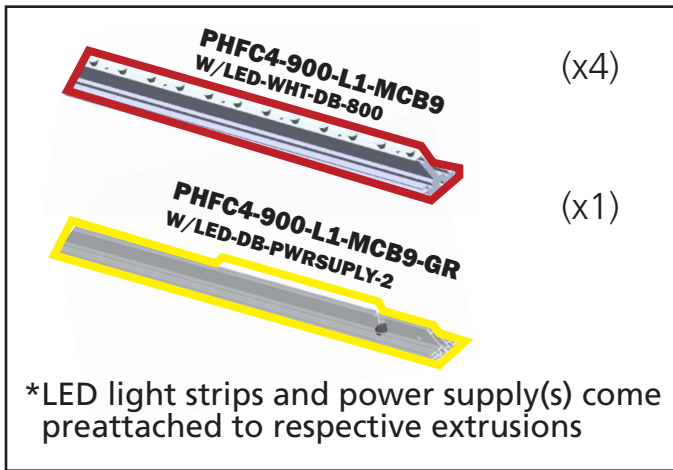

Back View

\*Not reflective of final connection

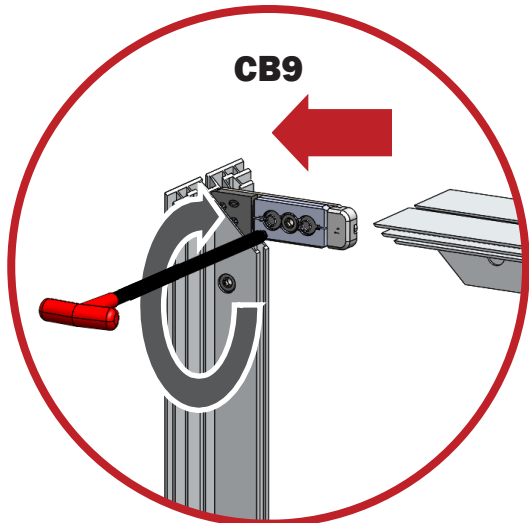

**CB9**

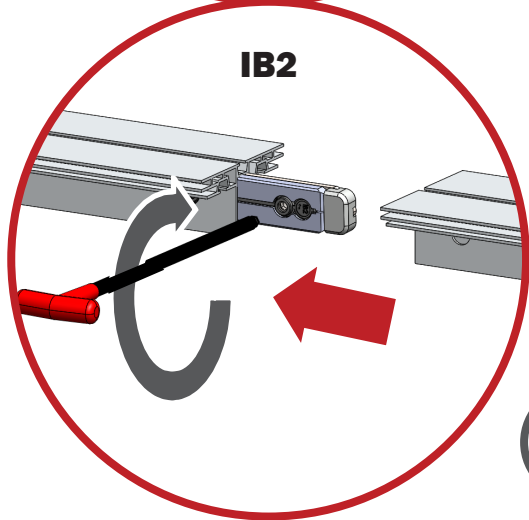

**IB2**

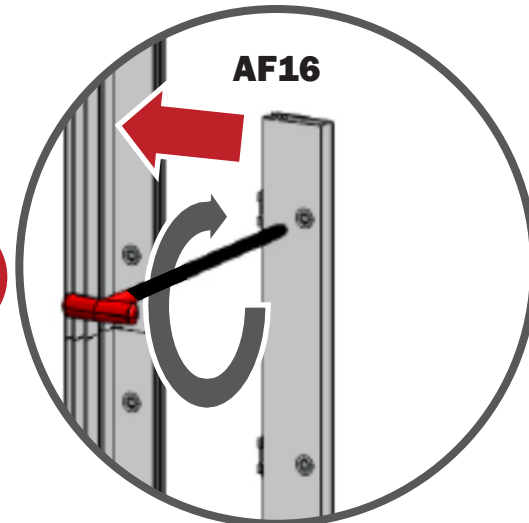

**AF16**

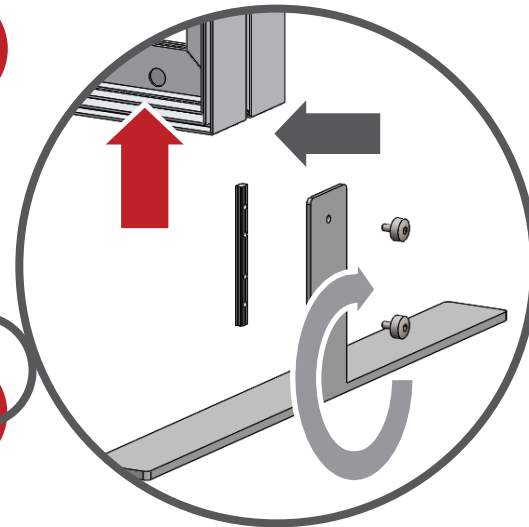

**AF16**

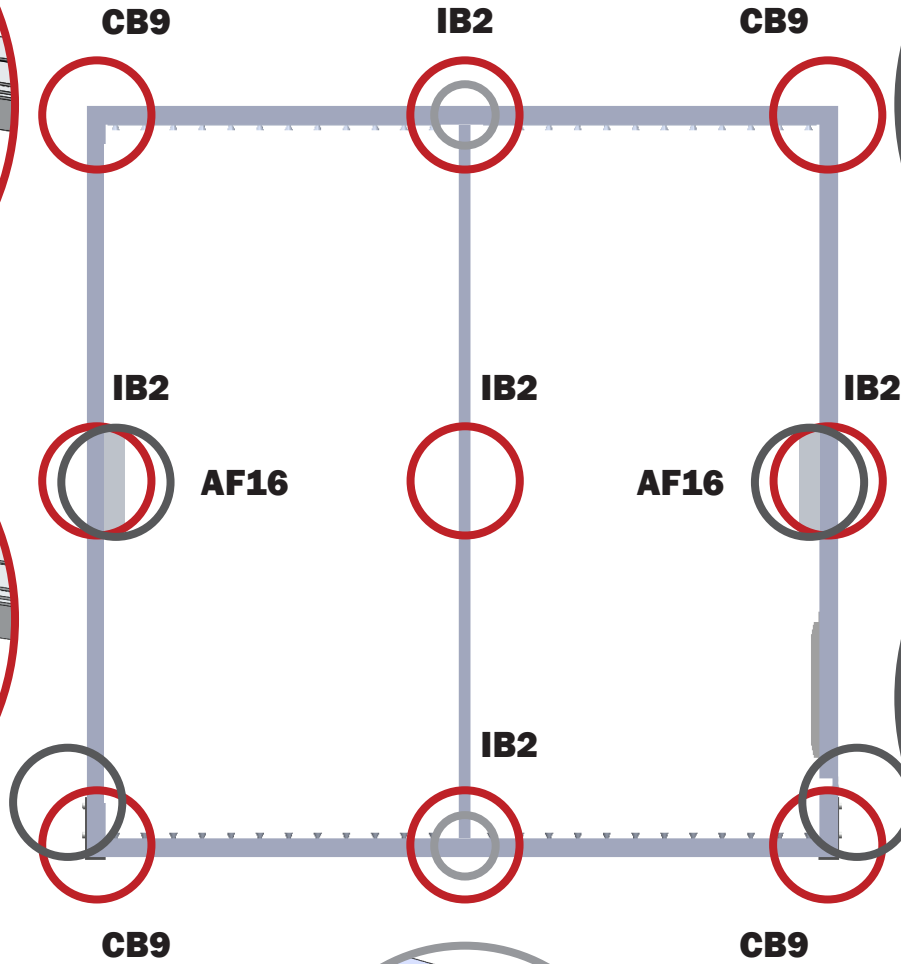

\*CB9 & IB2 connection are consistent

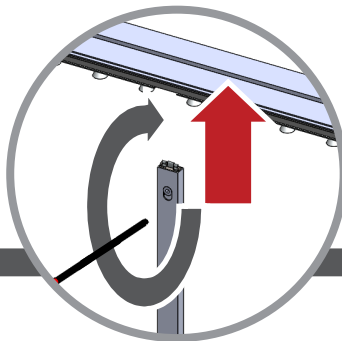

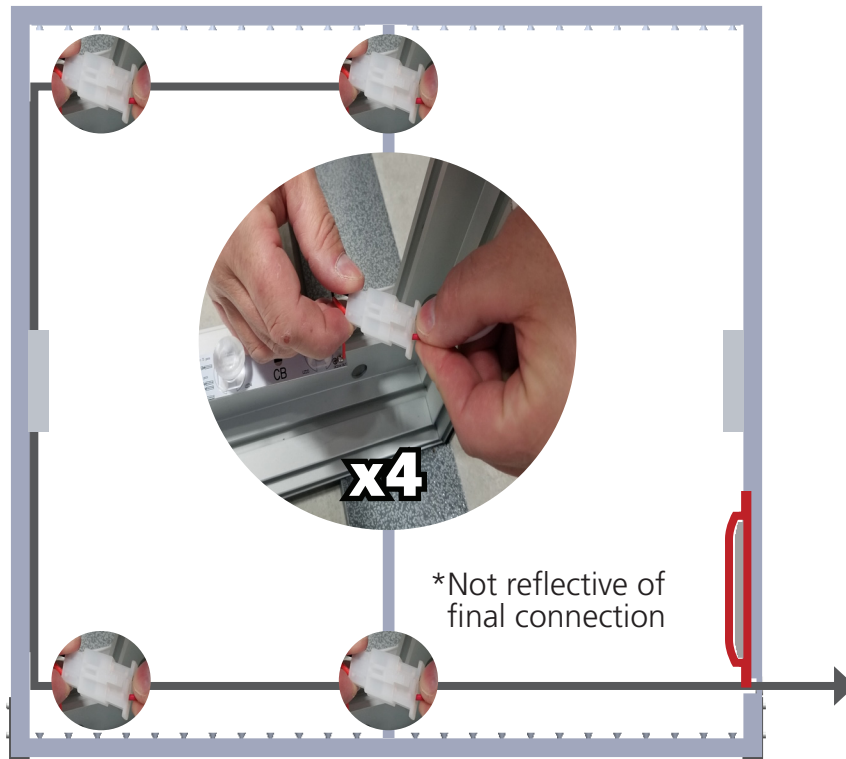
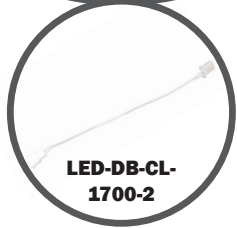
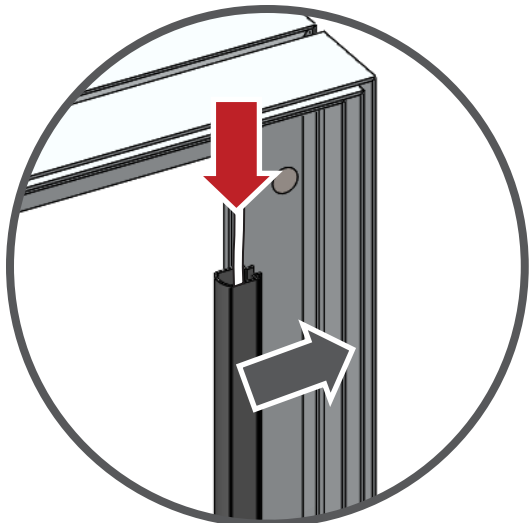



Fit graphic into corners, then "tap" into rest of frame channel.

"Sliding down" graphic is not recommended for best installation.

Repeat for backer.

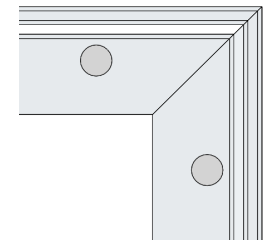
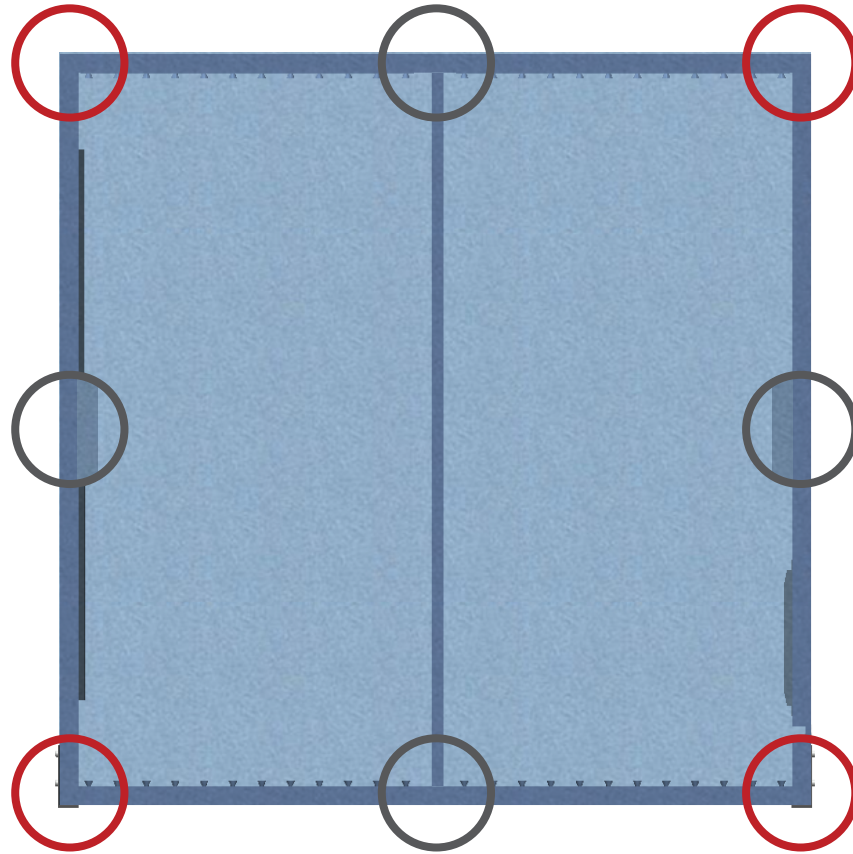

Backer  
2nd channel

Graphic  
1st channel

