

Vector Frame Hanging Lightbox 40'x5'

Vector Frame Hanging Light Boxes feature durable 100mm (4") aluminum extrusion frames, push-fit Intensity backlit fabric graphics and pre-installed LED top and bottom lighting. Your choice of one or two Intensity backlit push-fit fabric graphics. LED lights come attached to the frame, making set-up as simple as assembling the frame, and applying the push-fit graphics. Rigging and electrical from ceiling is required.



features and benefits:

- 100mm (4") silver extrusion frame
- Pre-attached LED lighting strips on top & bottom
- Single or double sided push-fit fabric graphics
- Hangs from the ceiling; rigging and electrical from ceiling is required.
- Easy assembly
- Comes packaged in wheeled molded case for transport and storage
- Lifetime frame warranty against manufacturer defects
- 90 day light warranty

dimensions:

Hardware

Graphic

Assembled unit:
472.44"w x 59.06"h x 3.94"d
12000mm(w) x 1501mm(h) x 101mm(d)

Refer to related graphic template for more information.

Approximate weight without case:
176 lbs / 80 kgs

One year graphic warranty

Visit:
<https://www.tradeshowplus.com>

Shipping

additional information:

Packing case(s):
2 OCE

Graphic material options:
Double-sided: 2 Backlit Intensity push-fit graphics

Shipping dimensions:
OCE: Expandable case length (l) may vary
40"-66"l x 18"h x 18"d
1016mm-1677mm(l) x 458mm(h) x 458mm(d)

Double-sided: 1 Backlit Intensity push-fit graphic + Printed Eclipse Fabric graphic + Opaque Liner

Approximate case shipping weight:
24 lbs / 11 kg

Single-sided: 1 Backlit Intensity push-fit graphic + Opaque Liner

Approximate total shipping weight
(includes cases & graphics):
312 lbs / 142 kgs

Lighting Power Requirements:

Watts: 960W	Amps: 33.28A	Volts: 100-240V
----------------	-----------------	--------------------



This product may include the following materials for recycle:
aluminum, select wood, fabric, cardboard, paper, steel, and plastics.

When included in a larger order, a different packaging solution will be provided to accommodate all contents of the order. Individual packaging may no longer be provided.

We are continually improving and modifying our product range and reserve the right to vary the specifications without prior notice. All dimensions and weights quoted are approximate and we accept no responsibility for variance. E&OE. See Graphic Templates for graphic bleed specifications.

Included In Your Kit

Extrusions	LED-Preattached		PHFC4-1500-L1-MCB9-SH W/LED-DB-PWRSUPLY-2 (x1)
			PHFC4-1500-L1-MCB9-GR-SH W/LED-DB-PWRSUPLY-2 (x1)
			PHFC4-1500-L1-L1-SH W/LED-DB-PWRSUPLY-2 (x6)
			PHFC4-1500-L1-L1 (x6)
			PHFC4-1500-L1-MCB9 (x2)
		*LED light strips and power supply(s) come preattached to respective extrusions	
			PHFC4-1500-MCB9-MCB9 (x2)

				
LED-DB-CL-1500-2 (x8)	LED-DB-PWRSUPLY-2-CL-800 (x5)	LED-DB-PWRSUPLY-2-CL-1500 (x3)	LED-DB-PWRSUPLY-2-CL-2500 (x3)	LED-DB-PWRCORD-2 (x2)

	WME-1200
	CH-SP4-HD-06
(x2)	

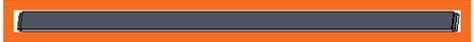
	PH1-1410-L-L (x7)		(x1)
---	-----------------------------	---	------

	PHFC-PLT-3W-T (x28)
---	-------------------------------

	IB2-0 (x14)
---	-----------------------

	CB9 (x4)
--	--------------------

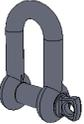
	SHACKLE (x8)
--	------------------------

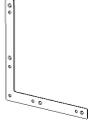
	PHFC-PLT-2W-90 (x8)
--	-------------------------------

	Graphic VF-LB-H-40-05-G (x2)
---	--

	HARDWARE (x72)
---	--------------------------

*Not to scale

Labeling Diagram 1

Lay out frame by connecting extrusions with their matching labeled extrusion, using the connectors shown.

Note: Hole-punched extrusions must be used for the top of the frame.

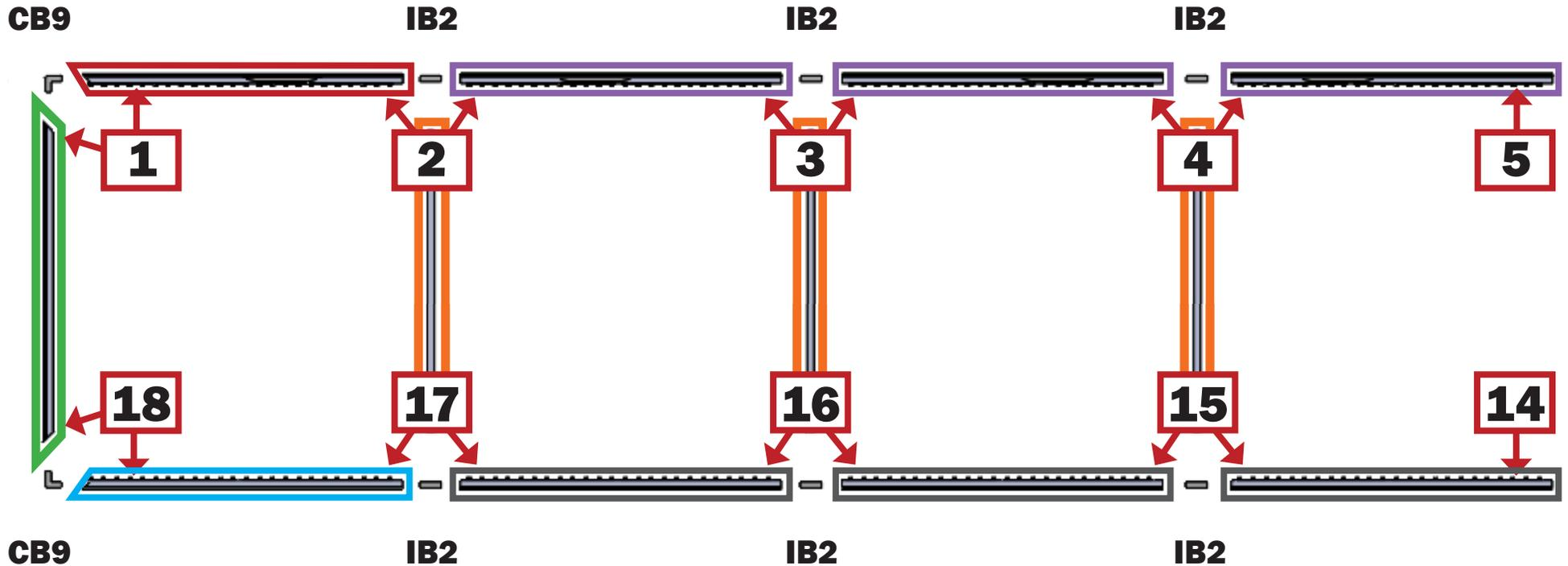

Labeling Diagram 2

Lay out frame by connecting extrusions with their matching labeled extrusion, using the connectors shown.

Note: Hole-punched extrusions must be used for the top of the frame.

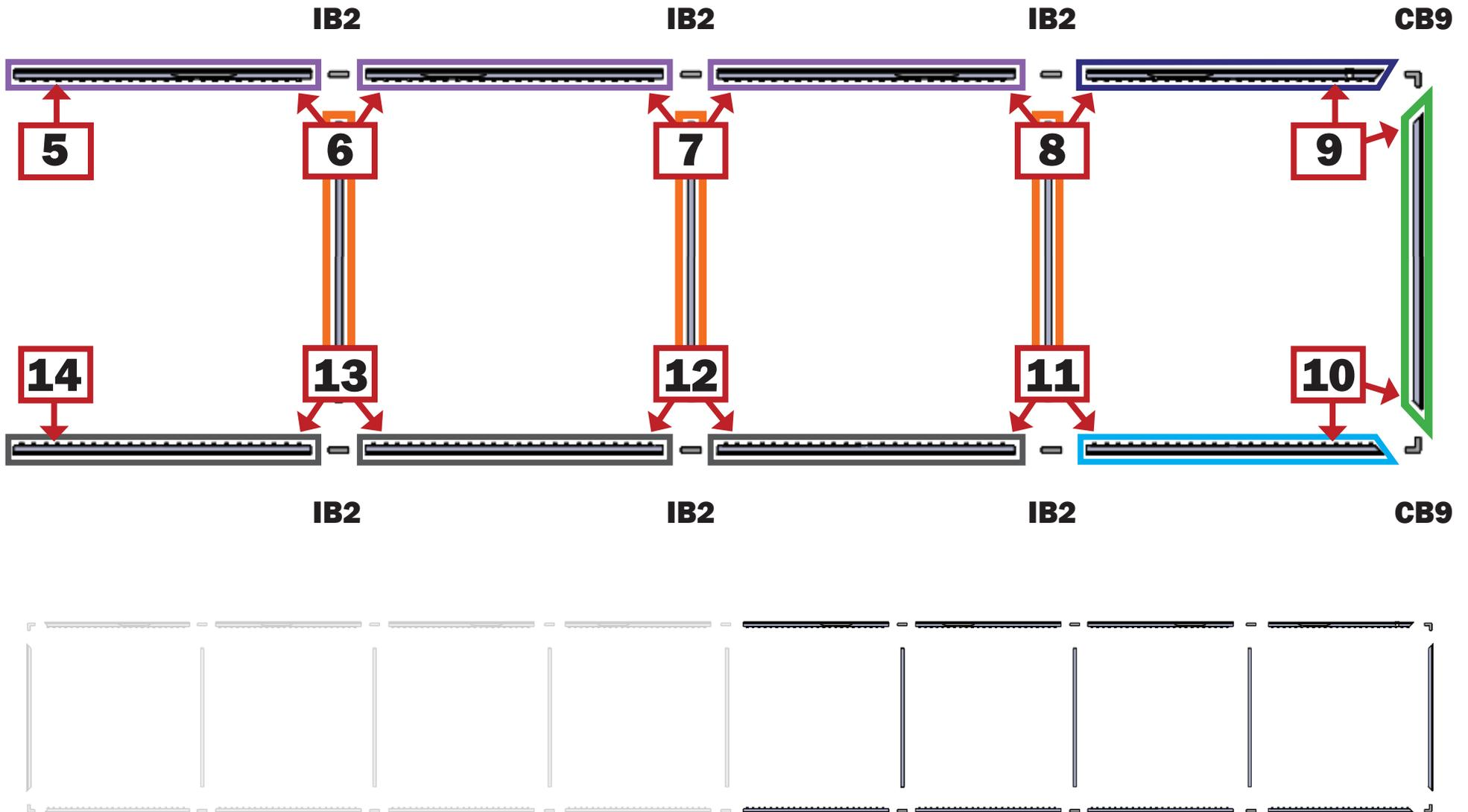

Frame Assembly

Assemble frame by connecting extrusions with their matching labeled extrusion, using the connectors shown. Line up each extrusion of the connecting frames before tightening.

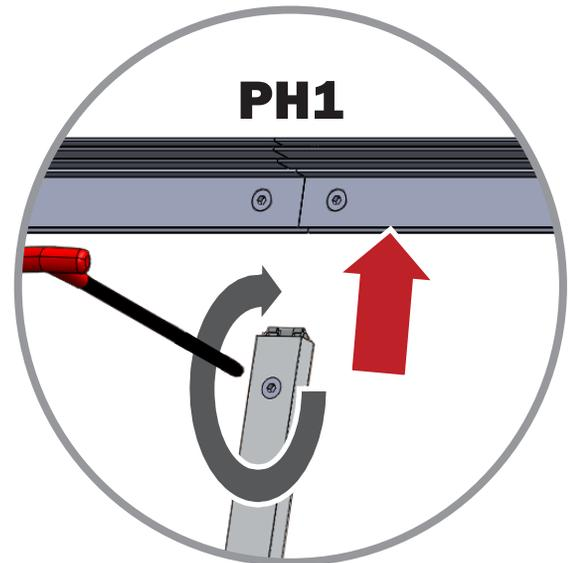
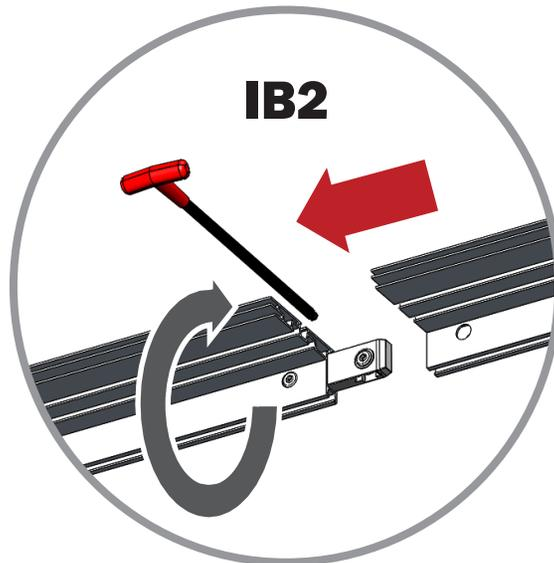
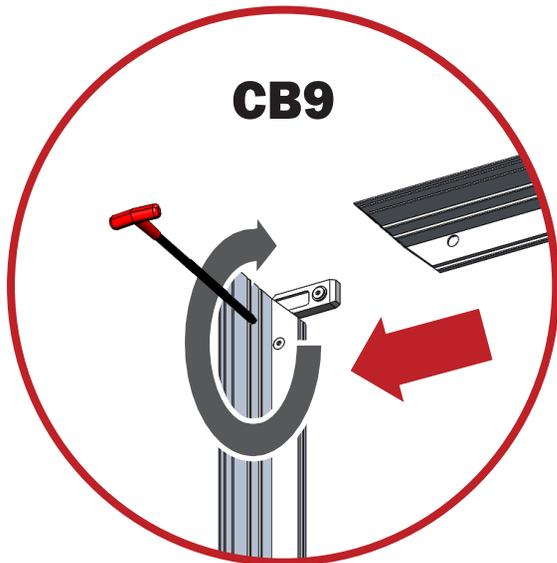
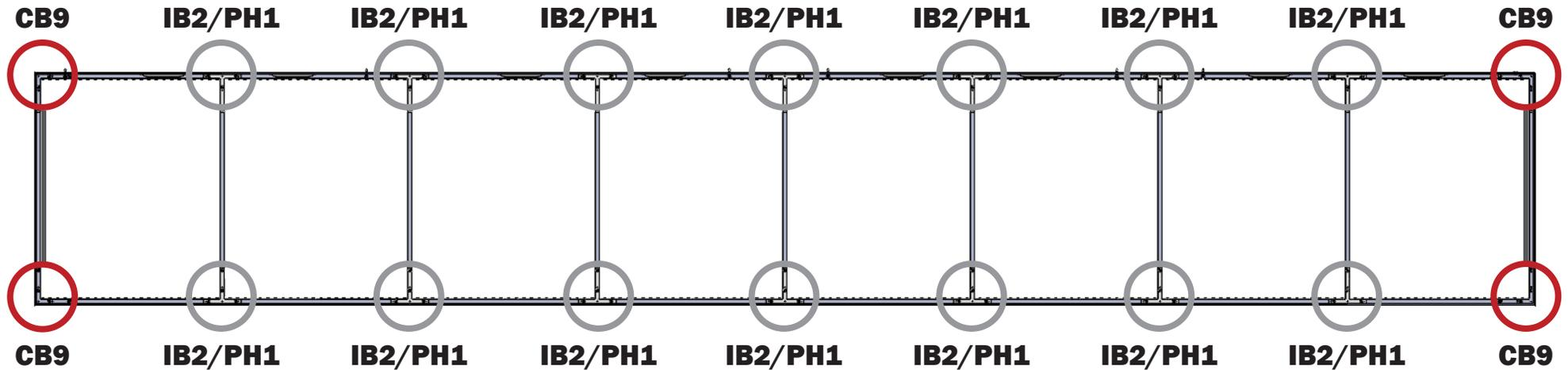

Bracket Attachments

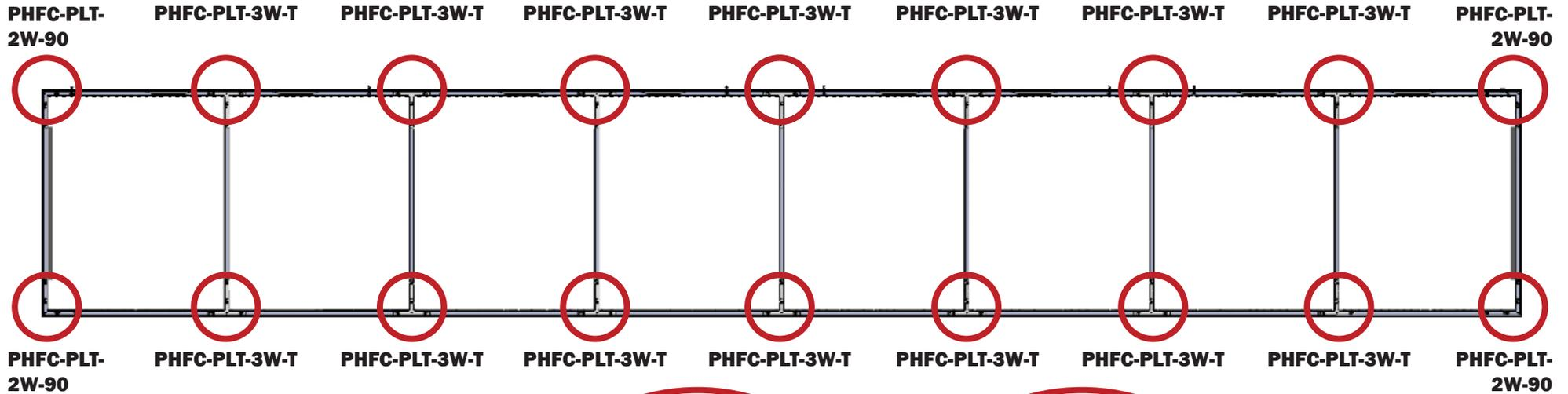
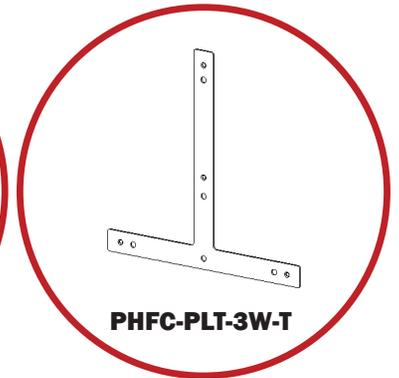
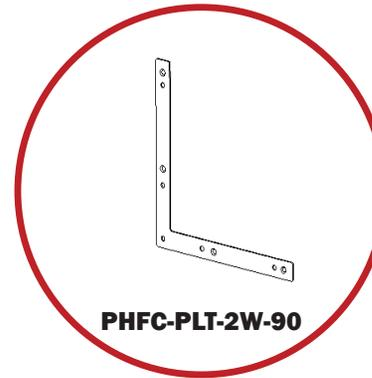

Fit PHFC-PLT-2W-90 (x2) on both sides of extrusion in of one corner.

Screw secure with provided hardware. Repeat with three remaining corners.



Repeat with PHFC-PLT-3W-T (x2) at horizontal breaks in the frame.

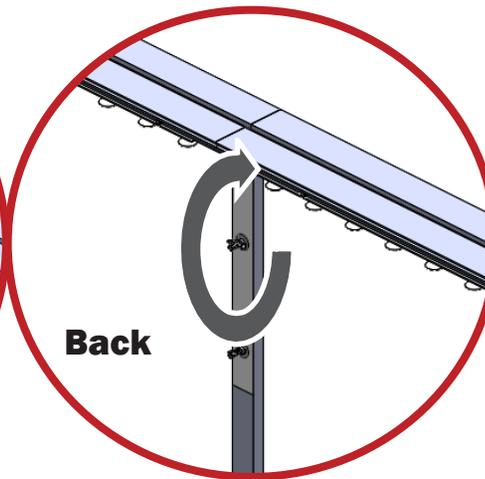
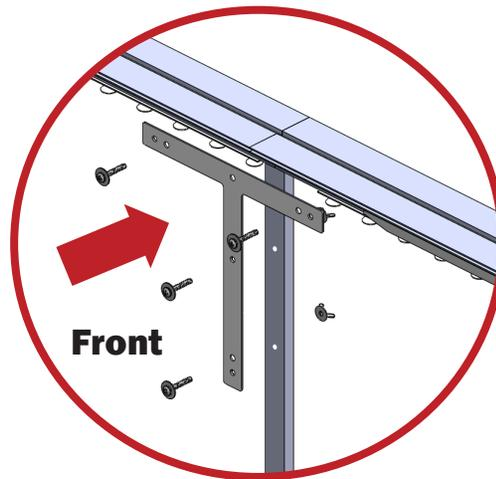

Wiring Diagram 1

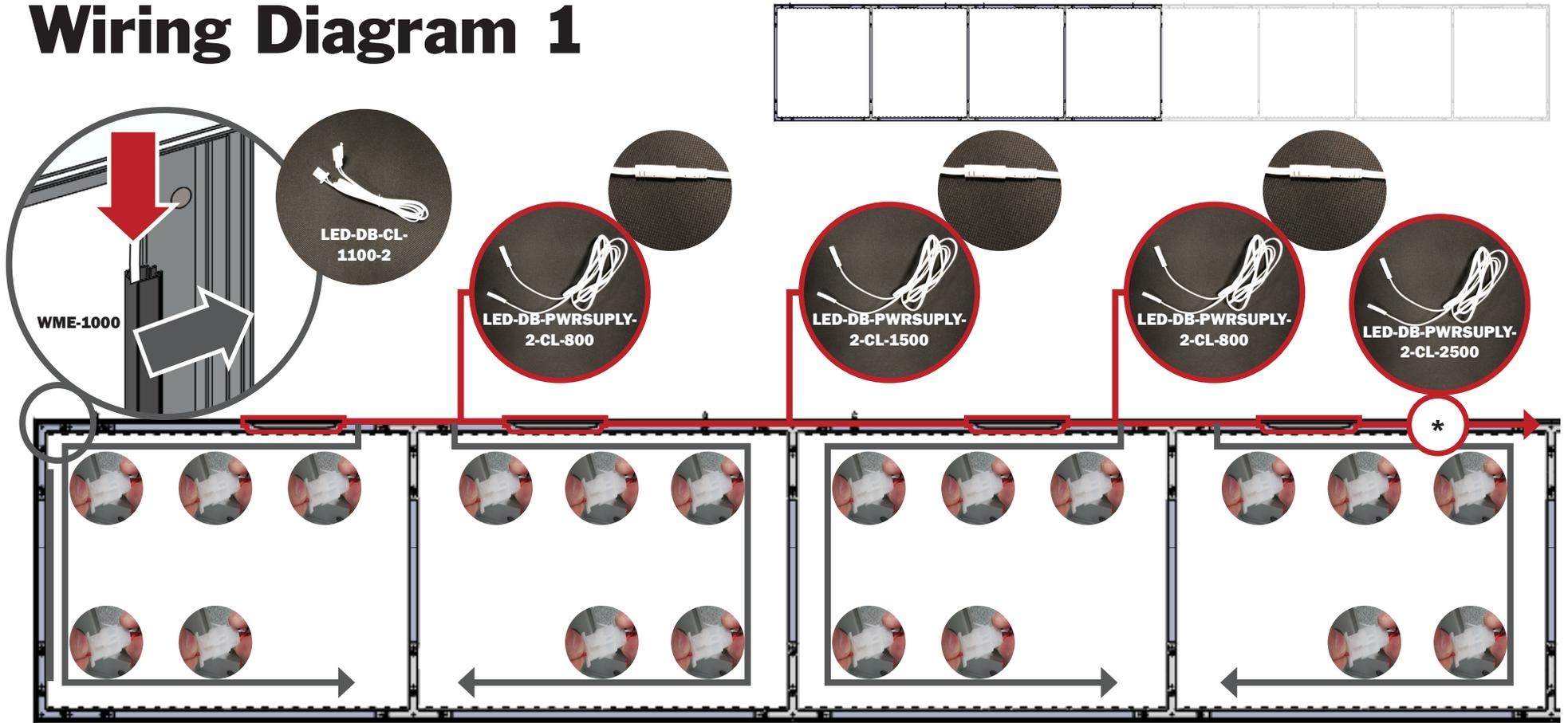

Connect the light strips along the top and bottom of the frame together with their clips per the diagram above. (left side of the frame)

Connect the top and bottom end light strips together with the LED-DB-CL-800-2, and house them in the WME-800. (top)



* Connect the three LED-DB-PWRSUPPLY-2-CL-2500 (x3) to each other and feed until it exits the grommet hole at the top of the right side of the frame.

Connect to one of the LED-DB-PWRCORD-2 and to the power supply when fully assembled and installed.

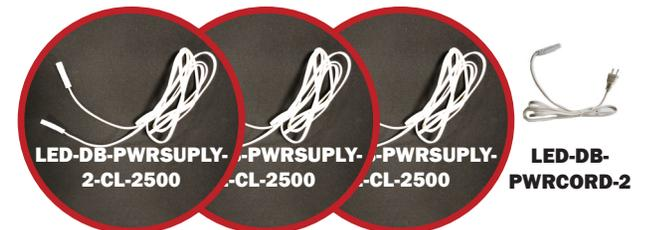

Wiring Diagram 2

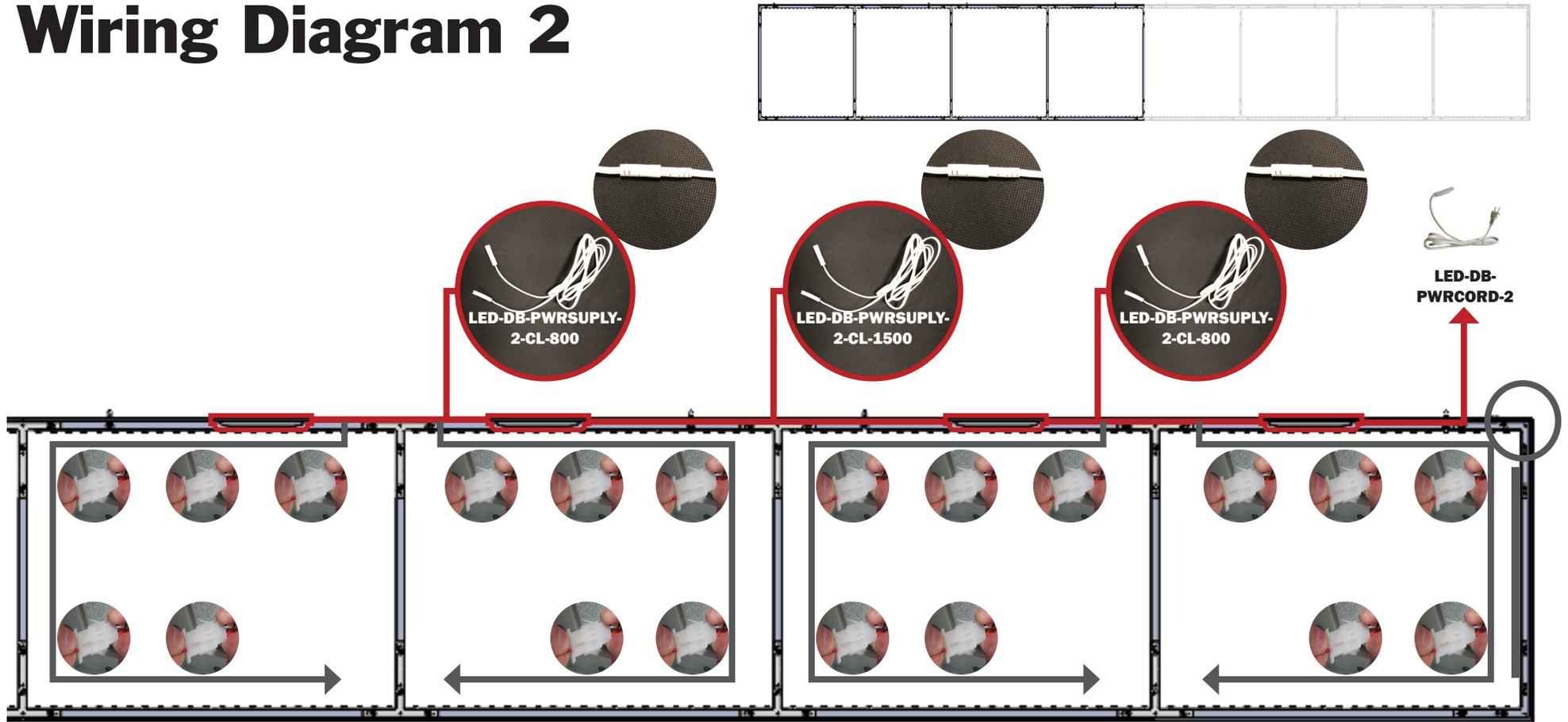

Connect the light strips along the top and bottom of the frame together with their clips per the diagram above. (right side of the frame)

Connect the top and bottom end light strips together with the LED-DB-CL-800-2, and house them in the WME-800. (right)

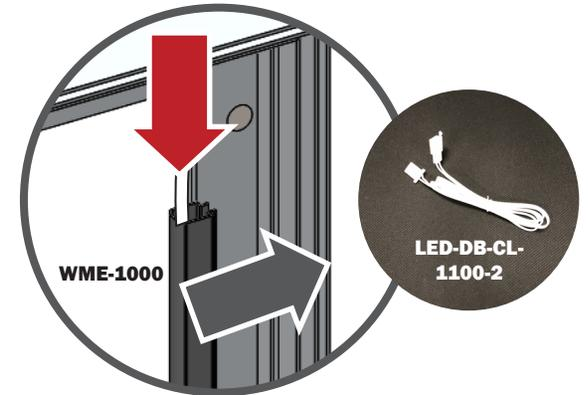

Graphic Application

Double sided: (2) Intensity Push fit Graphics

VF-LB-H-XX-XX-S-G (x2)

Fit graphics into the outer graphic channel on both sides

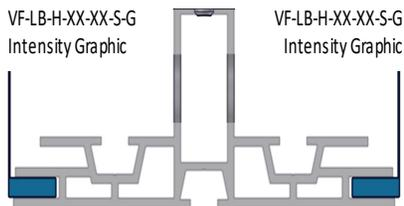

Both sides illuminated

Double sided: (1) Intensity Push fit graphic + (1) Opaque Liner + (1) Printed Eclipse Fabric Graphic

VF-LB-H-XX-XX-S-G
VF-LB-H-XX-XX-OP-LN
VF-LB-H-XX-XX-S-EBS-G or VF-LB-H-XX-XX-D-EBS-G

Step 1: Fit the Opaque Liner into the inner channel on the non-illuminated side
Step 2: Fit the Printed Eclipse Fabric Graphic over the Opaque Liner into the outer graphic channel
Step 3: Fit the Intensity graphic into the outer graphic channel on the illuminated side

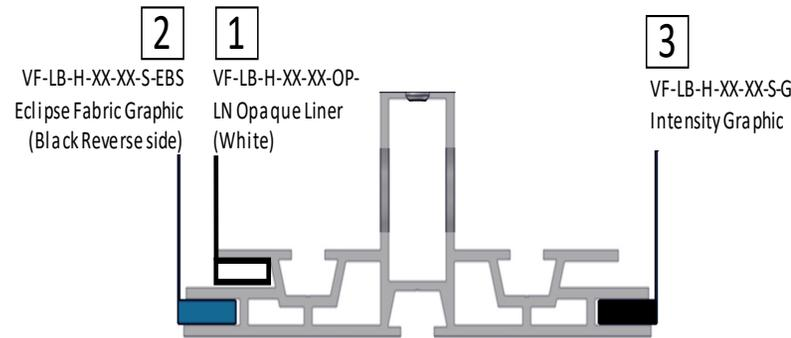

Non-illuminated side | Illuminated side

Illuminated side can be reversed by applying graphics and liner to opposite sides

Single Sided: (1) Backlit intensity push-fit graphic + (1) Opaque Liner

VF-LB-H-XX-XX-S-G
VF-LB-H-XX-XX-OP-LN

Fit graphic and opaque liner into the outer channels on either sides

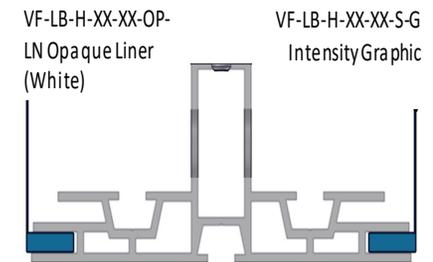

Non-illuminated side | Illuminated side

See next page for additional graphic application details

Graphic Application

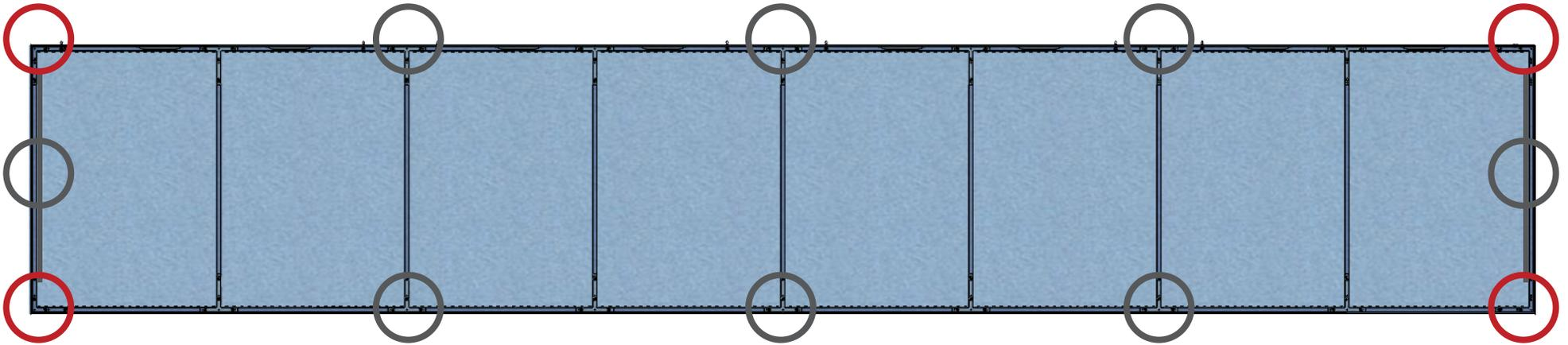

Fit graphic into four corners. (left)

“Tap” into rest of channel along the frame. (right)

“Sliding down” graphic is not recommended for best installation.

Repeat for back graphic or opaque liner after fitting shackles (next page).

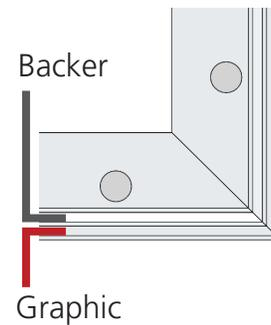
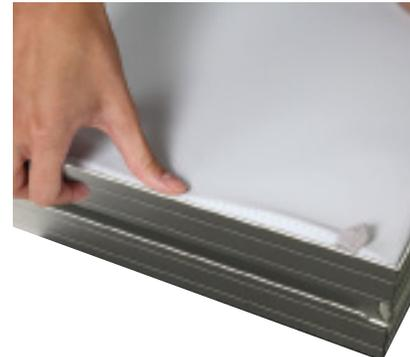

Shackle Fitting

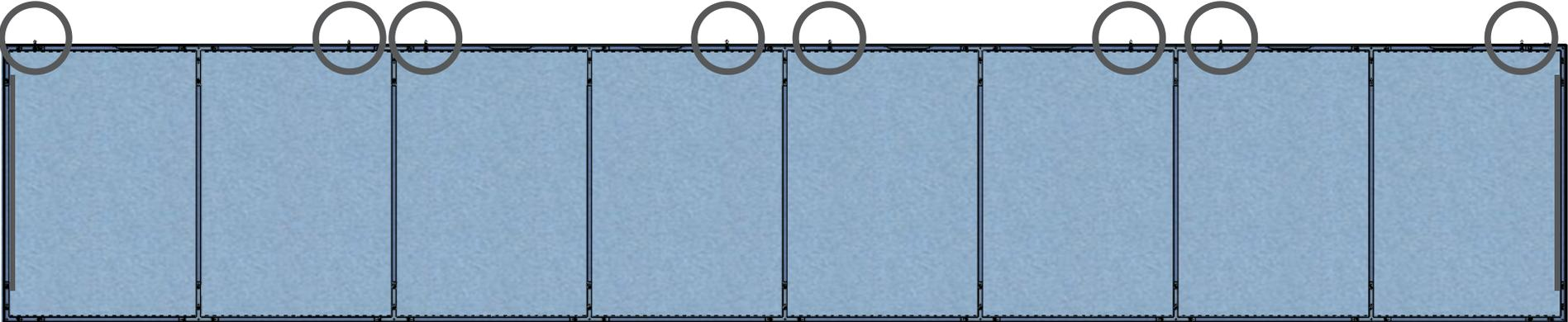

Fit first shackle through top extrusion hole. (left)

Lock shackle in place with screw. (right)

Repeat for other side.

