

# Vector Frame Geometric Rectangle 05

Vector Frame is a collection of modern extrusion-based fabric graphic banner displays. Vector Frame is easy to assemble and disassemble and provides your choice of single-sided or double-sided integrated fabric graphic murals.



## features and benefits:

- 50mm silver extrusion frame
- Single or double-sided SEG dye-sublimated fabric graphics
- Easy assembly
- Comes packaged in one OCL wheeled molded case for transport or storage
- Lifetime hardware warranty against manufacturer defects

## dimensions:

Hardware

Graphic

Assembled unit:  
119" w x 94.75" h x 19.7" d  
3022mm(w) x 2406mm(h) x 500mm(d)

Refer to related graphic template for more information.

Approximate weight with cases:  
56 lbs / 25 kgs

Visit:  
[www.tradeshowplus.com](http://www.tradeshowplus.com)

Shipping

Packing Cases:  
1 OCL

Shipping dimensions:  
56" l x 19" w x 19" h  
1422mm(l) x 483mm(w) x 483mm(h)

Approximate shipping weight (entire kit):  
60 lbs / 27 kgs

## additional information:

Graphic material:  
Dye-sublimated fabric

Optional lighting available

We are continually improving and modifying our product range and reserve the right to vary the specifications without prior notice. All dimensions and weights quoted are approximate and we accept no responsibility for variance. E&OE. See Graphic Templates for graphic bleed specifications.

# Included In Your Kit

Tools, Components, & Extrusions



5MM ALLEN-T x1



CB9 x4



PHFC2-600-L1-L1 x2

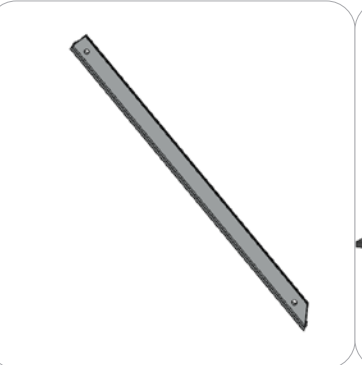

PHFC2-1200-L1-MCB9 x8

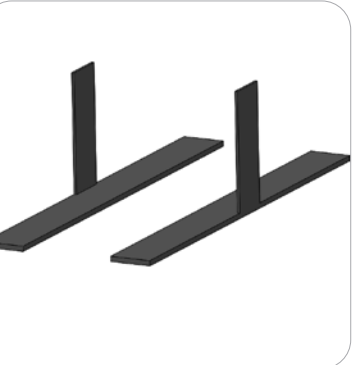

SW-FOOT-500-2 x1

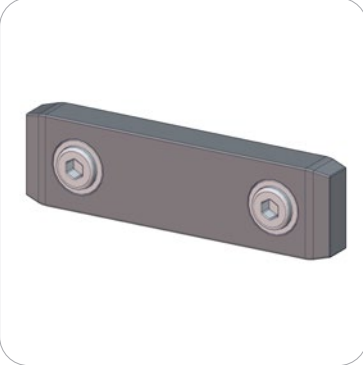

IB2 x8



PH2-1155-L1-S x4

Graphics

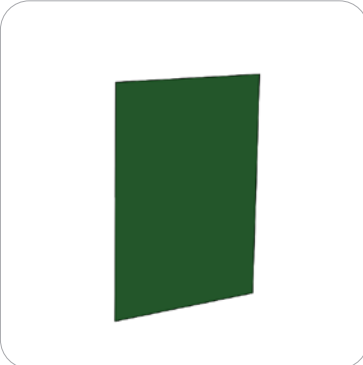

VF-R-05-G x1

# Exploded View

VF-R-05

Frame A

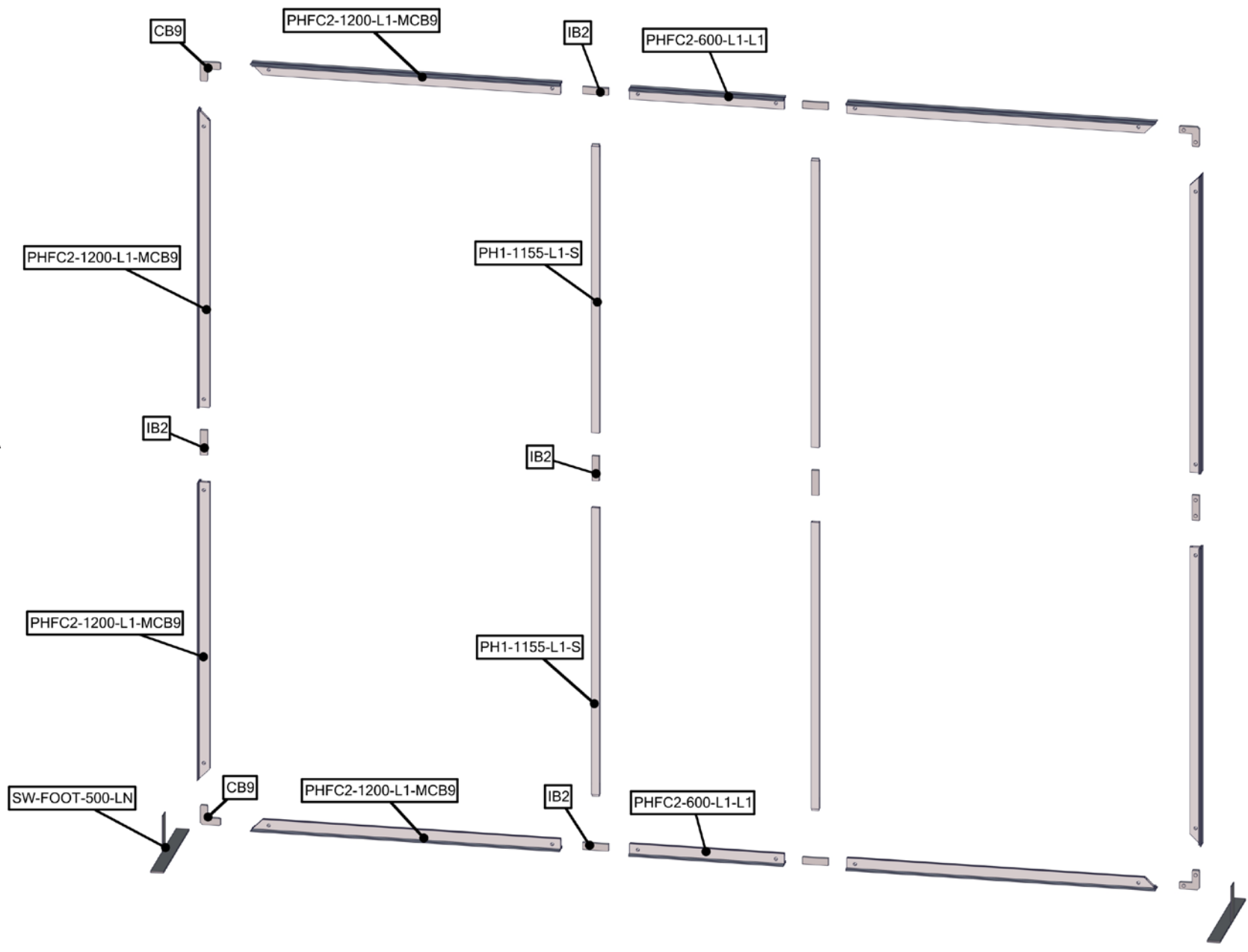

# Connection Methods

Extrusion based structures use a number of different yet simple connection methods. Your kit will include one or more of the connection methods shown below. Steps within the Kit Assembly will reference a specific method for each connection point.

## Connection Method 1: Cam Lock / Slide Lock

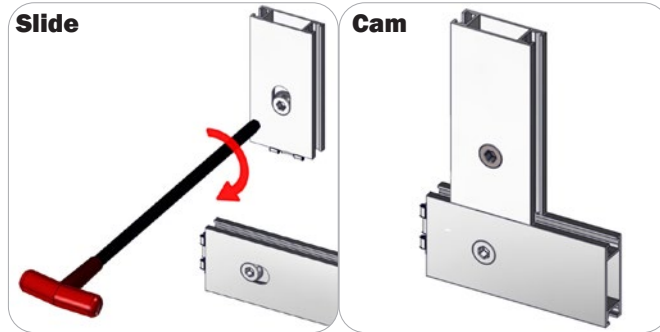

A cam lock equipped extrusion can lock to any cam lock channel. With the cam lock unlocked, set the teeth of the cam lock into the desired position on the cam lock channel. Using your allen key tool, carefully turn the lock clockwise to lock in place. Be sure to lock securely, but do not overtighten.

A slide lock equipped extrusion can also lock into any cam lock channel. When the slide lock is unlocked, pull back on the hex bolt head to retract the slide lock into the body of the extrusion. Slide locking procedure is the same as a cam lock.

## Connection Method 2: IB2 / Corner Brackets

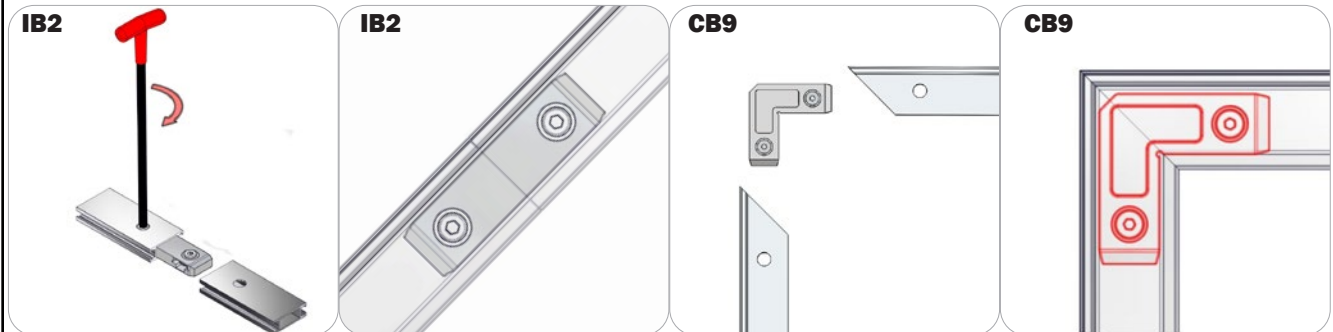

Press the hex bolt head in with your thumb and slide the extrusion and connector together so that the hex bolt head sits into the lock hole. Repeat with the second extrusion to the free end of the connector. Lock the extrusions together by turning carefully with the allen key tool. Be sure to lock securely, but do not overtighten.

## Connection Method 3: SW-FOOT

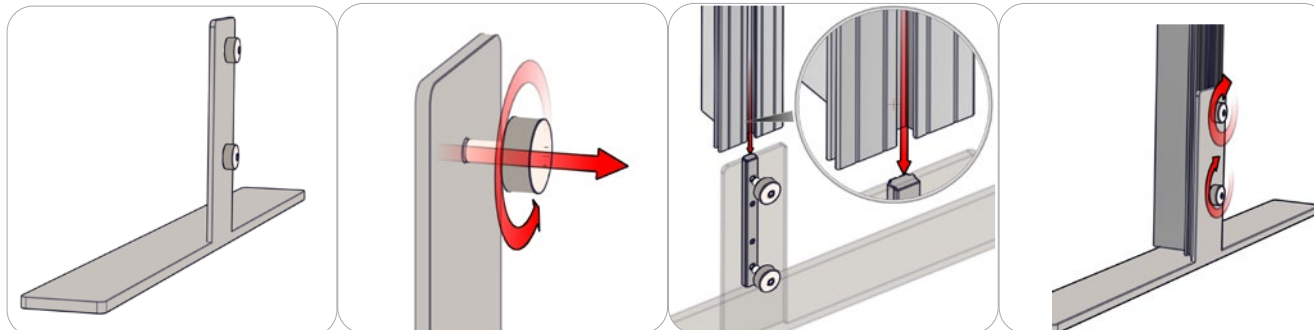

An SW-FOOT assembly consists of two thumb screws, an LN100, and SW-FOOT baseplate. Start by loosening the thumb screws (it is best not to completely remove the screws). Slide the extrusion onto the LN100 by utilizing its back cam channel. When the extrusion rests on baseplate or ground (depending on application), tighten the thumb screws to lock in place. Do not overtighten.

# Kit Assembly

## Step by Step

### Step 1.

Locate the components necessary for assembling Frame A. Assemble your frame in order according to the Exploded Diagram.

Please reference Connection Method 2 for more details.

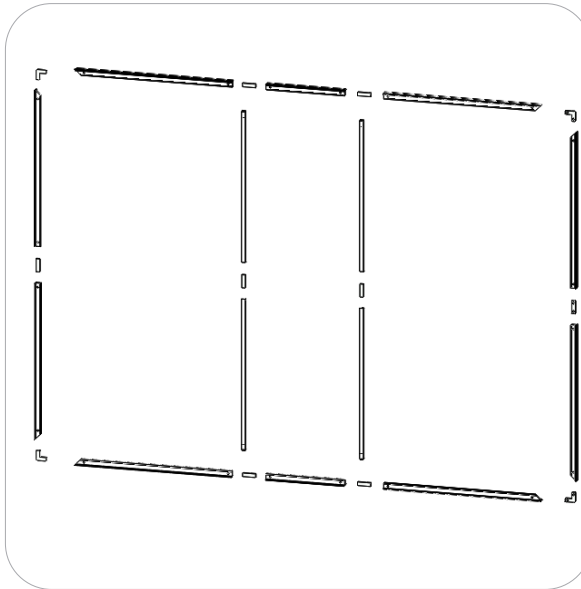
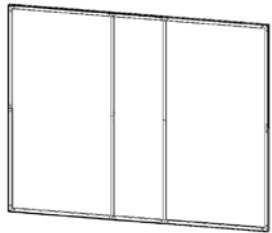

### Step 2.

Locate (2) SW feet. Attach to both sides of your frame to allow the frame to stand.

Please reference Connection Method 3 for more details.

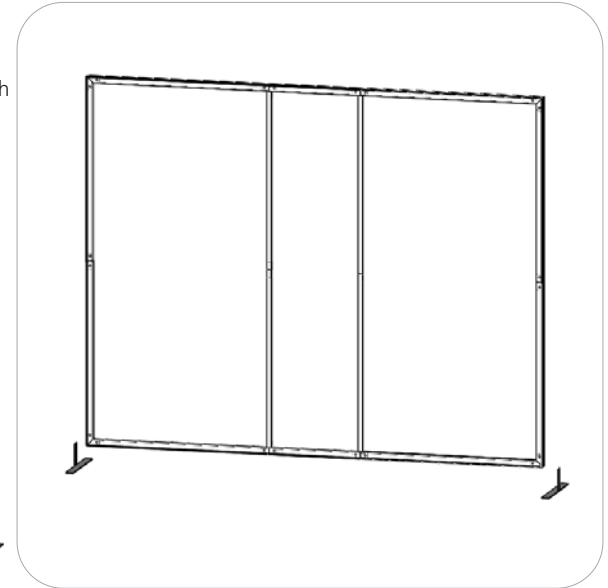
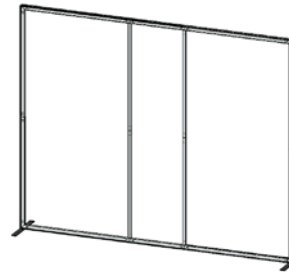

### Step 3.

Apply your VF-R-05 graphic to either side of your banner by pushing the edges of the graphic into the outer edge channels of the extrusions.

Setup Complete.

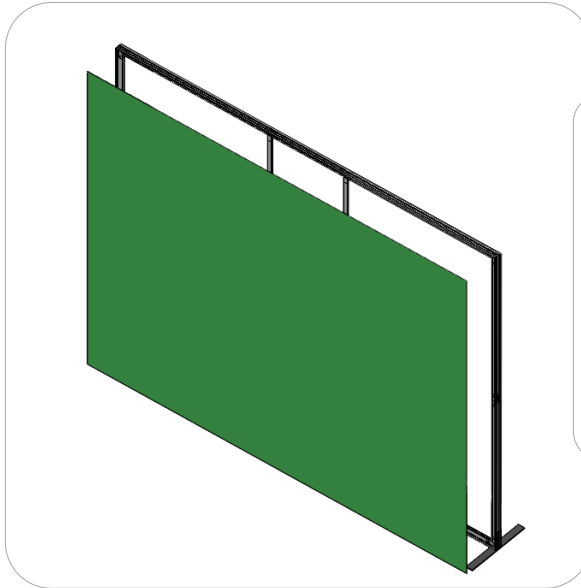
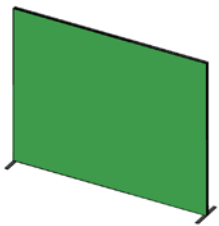

FCE-2 TO PHFC2

