



PANEL A (Inside)



PANEL A (Outside)

PANEL B



PANEL C (Inside)



PANEL C (Outside)



PANEL D (Inside)



PANEL D (Outside)

PANEL E



PANEL F (Inside)



PANEL F (Outside)

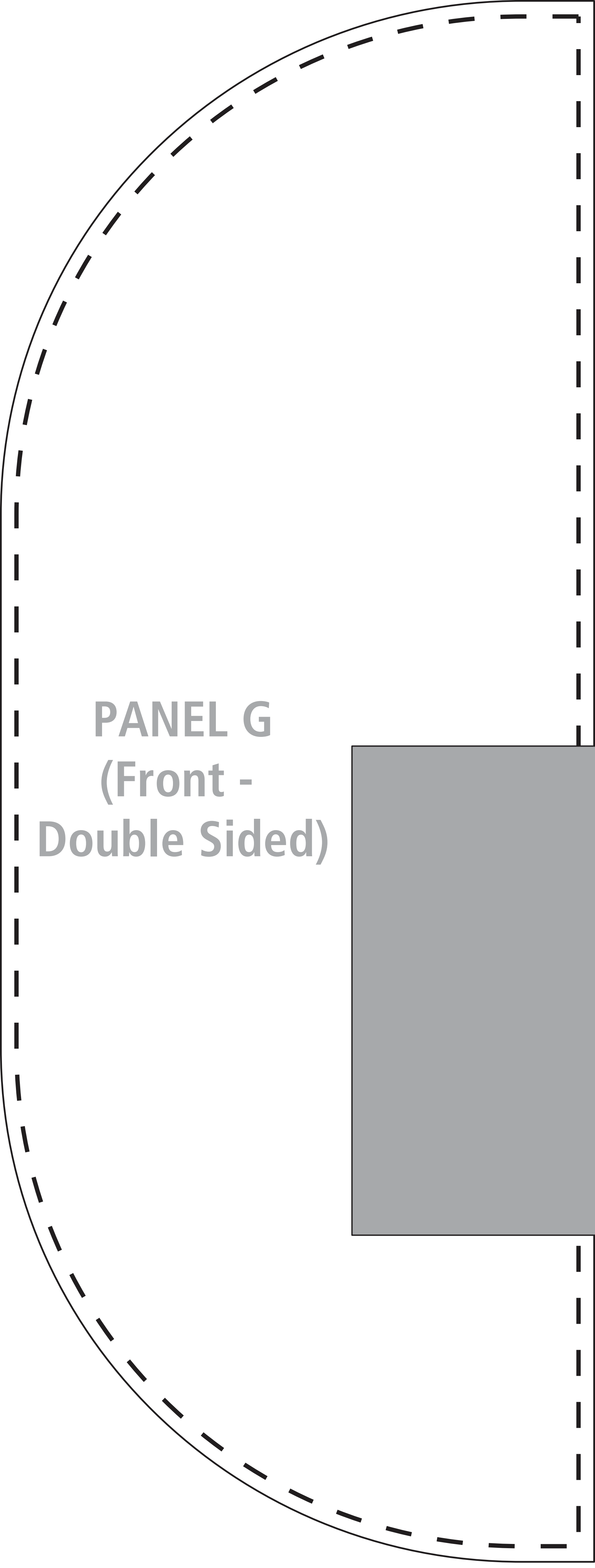

PANEL G
(Front -
Double Sided)

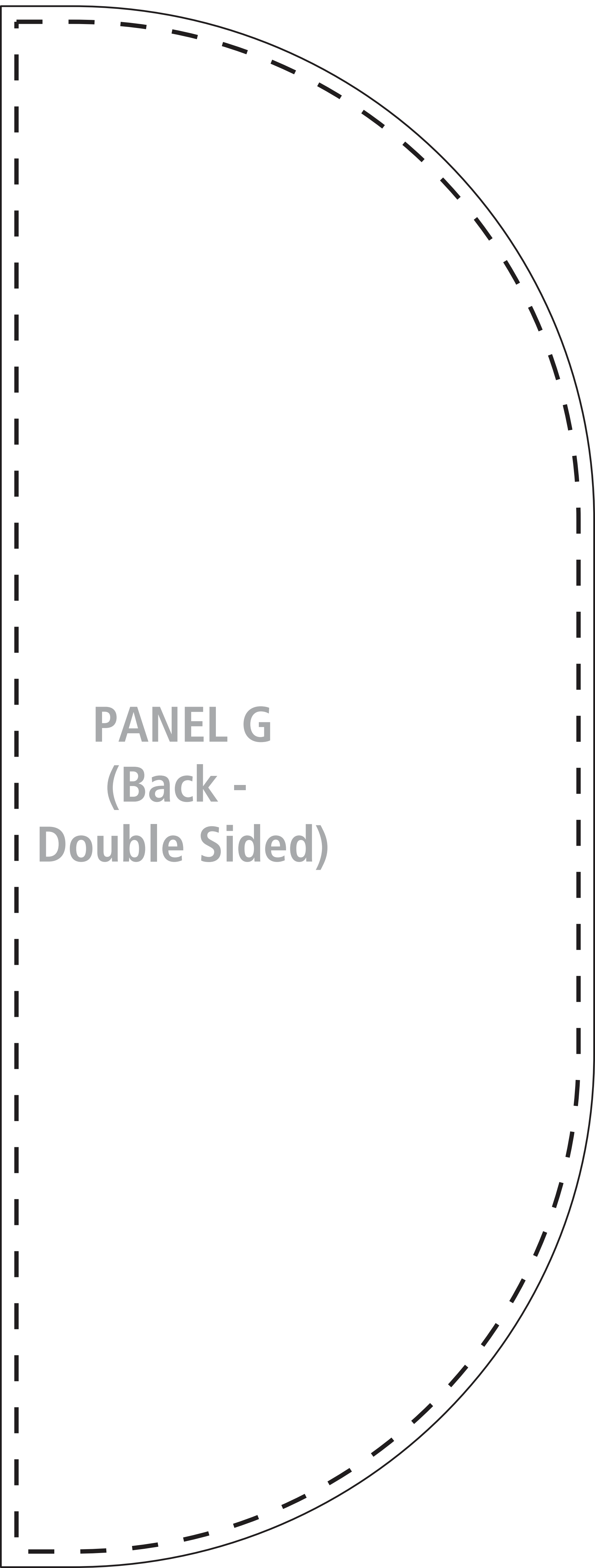

PANEL G
(Back -
Double Sided)

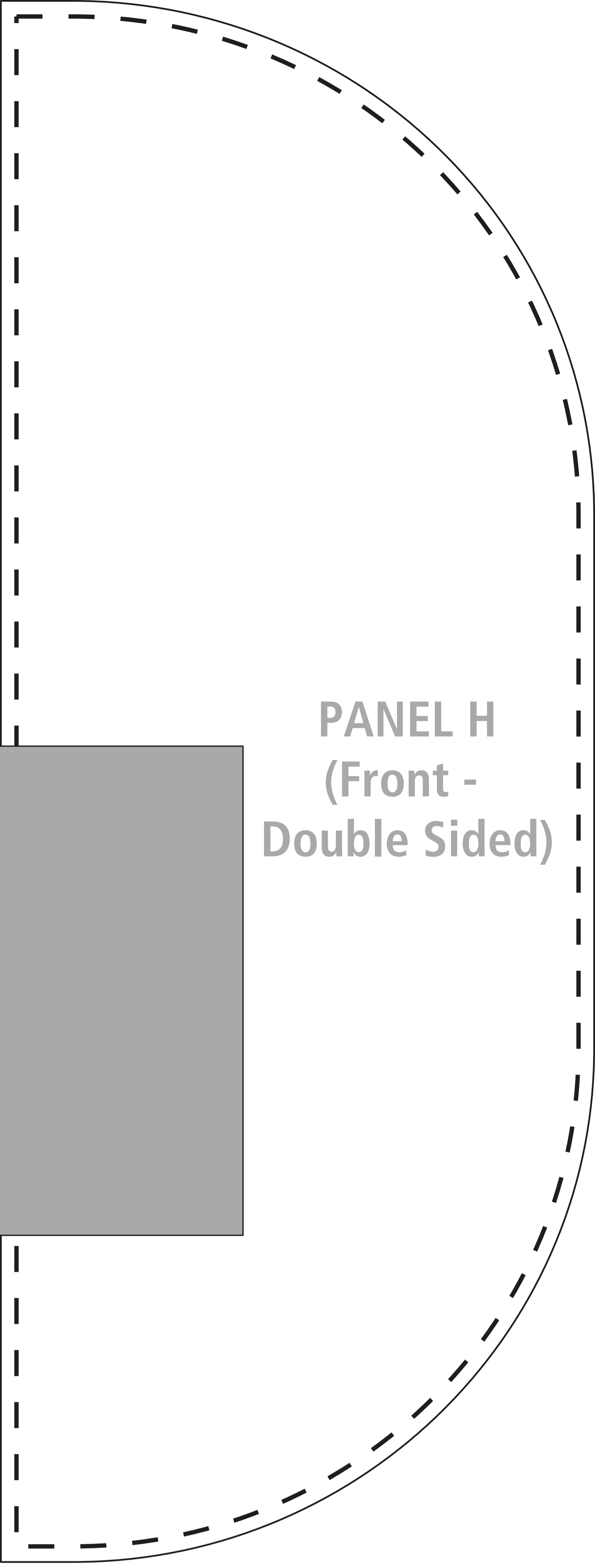

PANEL H
(Front -
Double Sided)

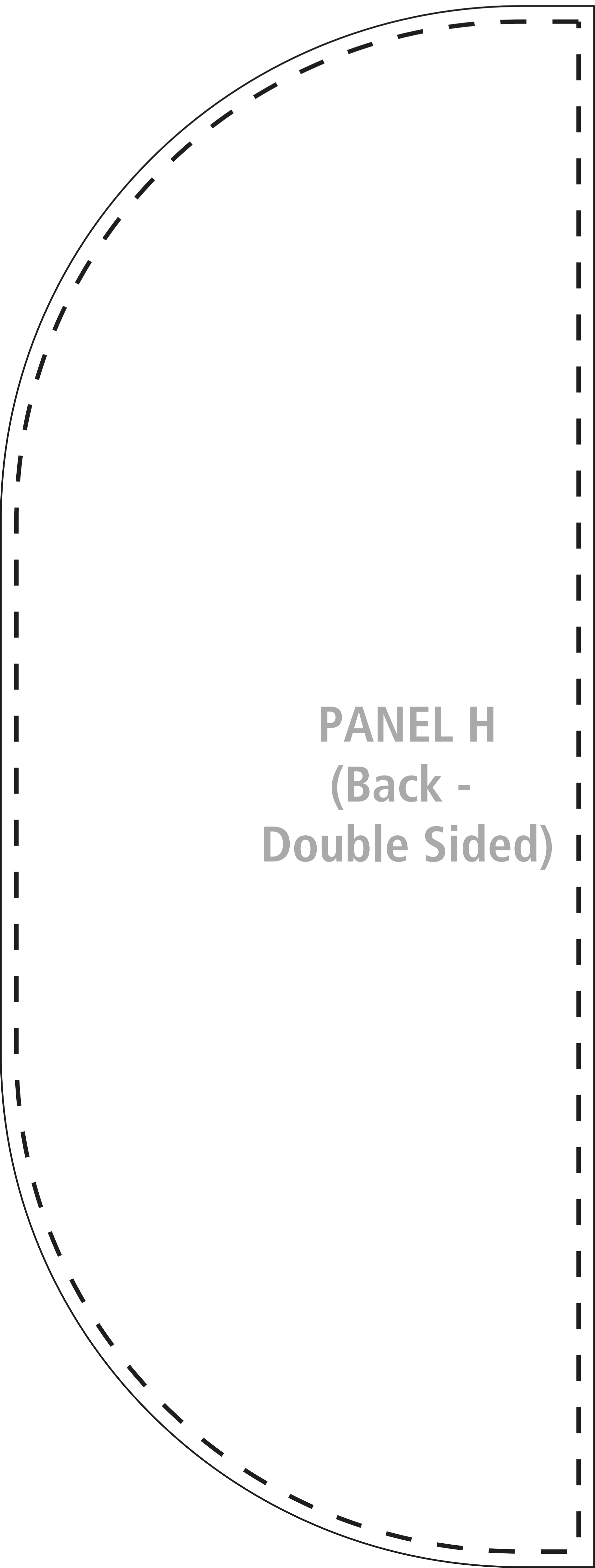

PANEL H
(Back -
Double Sided)

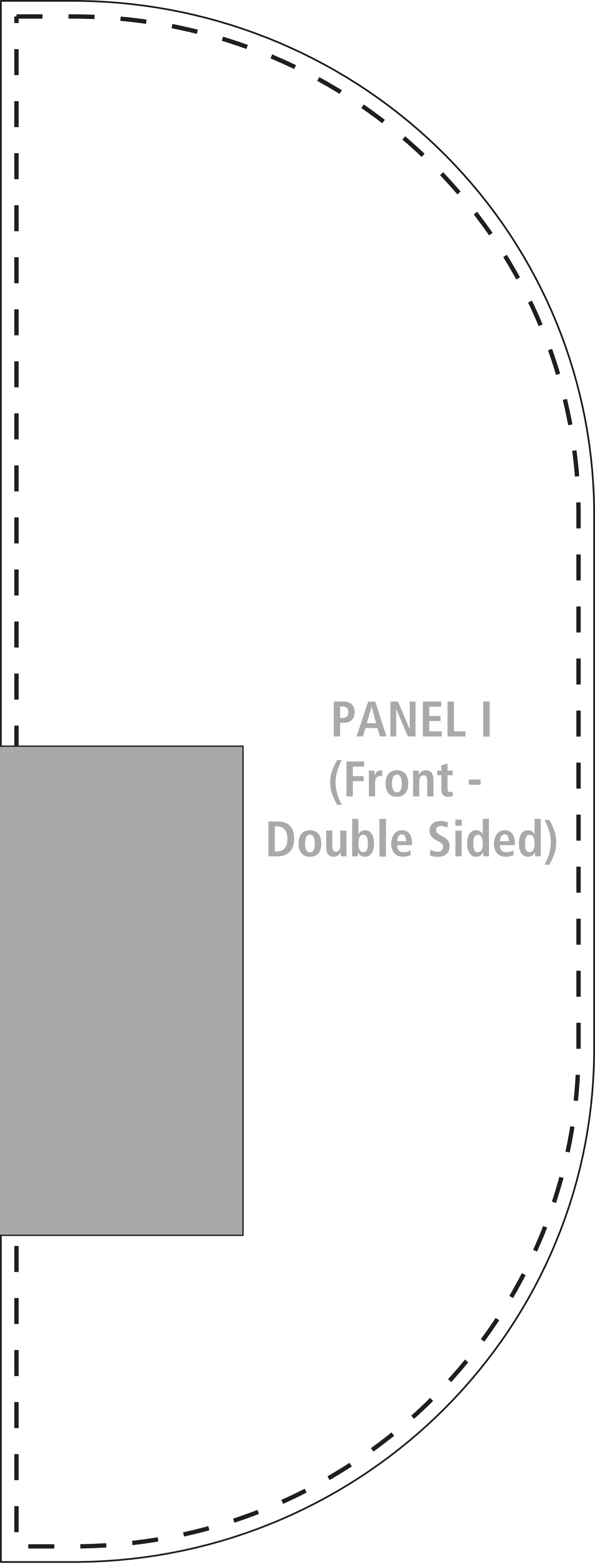

**PANEL I
(Front -
Double Sided)**

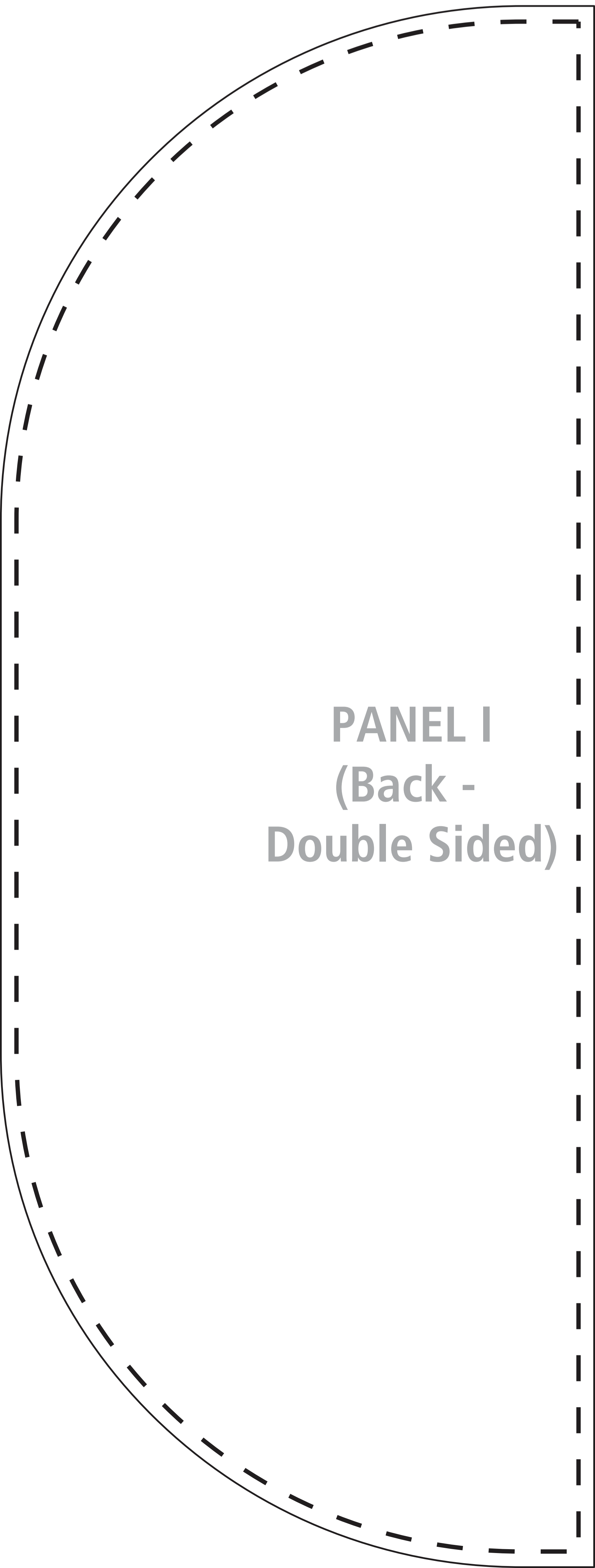

**PANEL I
(Back -
Double Sided)**

PANEL J

PANEL K

PANEL L

Hybrid Pro Modular Kit: Hybrid Pro Modular Kit 17

TEMPLATE @ 1/2 SIZE

Dye Sub Graphic Panel A and F (Double Sided)
Inside Dimension
Total Graphic Area: 117.3125"w x 22"h
Finished Graphic Area: 107.3125"w x 12"h
Outside Dimension
Total Graphic Area: 119.5"w x 22"h
Finished Graphic Area: 109.5"w x 12"h

Dye Sub Graphic Panel C and D (Double Sided)
Inside Dimension
Total Graphic Area: 120.75"w x 57.25"h
Finished Graphic Area: 110.75"w x 47.25"h
Outside Dimension
Total Graphic Area: 122.5625"w x 57.25"h
Finished Graphic Area: 112.5625"w x 47.25"h

Dye Sub Fabric Panel B and E
Total Graphic Area: 39.3125"w x 90.5"h
Finished Graphic Area: 35.3125"w x 86.5"h

Dye Sub Fabric Panel M and N
Total Graphic Area: 98.5"w x 98.25"h
Finished Graphic Area: 94.5"w x 94.25"h

UV Graphic J, K, L
Total Graphic Area: 38.25"w x 36.1875"h
Finished Graphic Area: 37.25"w x 35.1875"h

UV Graphic G, H, I
Total Graphic Area: 19"w x 50"h
Finished Graphic Area: 18"w x 49"h
(Graphic must be mirrored if designing
as double sided - not a standard offering)

Please be sure to include 2" bleed around
the perimeter of B, E, M and N.

Please be sure to include 5" bleed around
the perimeter of A, C, D and F.

Please be sure to include .5" bleed around
the perimeter of G, H, I, J, K and L.

Please consider obstructions and spaces
created by the extrusions when designing
your graphics.

Please design the hybrid counter artwork
on a separate template.

General Art Guidelines:

- CMYK Color Mode
- All Solid Coated Pantone colors should
be called out in the art as spot colors
- Embed all images and support files
- Resolution must be 200-240 ppi
at 1/2 size, 100-120 ppi at full size
- All fonts must be created to outlines
- Do not scale artboard
- Background color/images must
bleed to the edge of artboard
- Do not use spot colors from template
in your artwork as they will not print

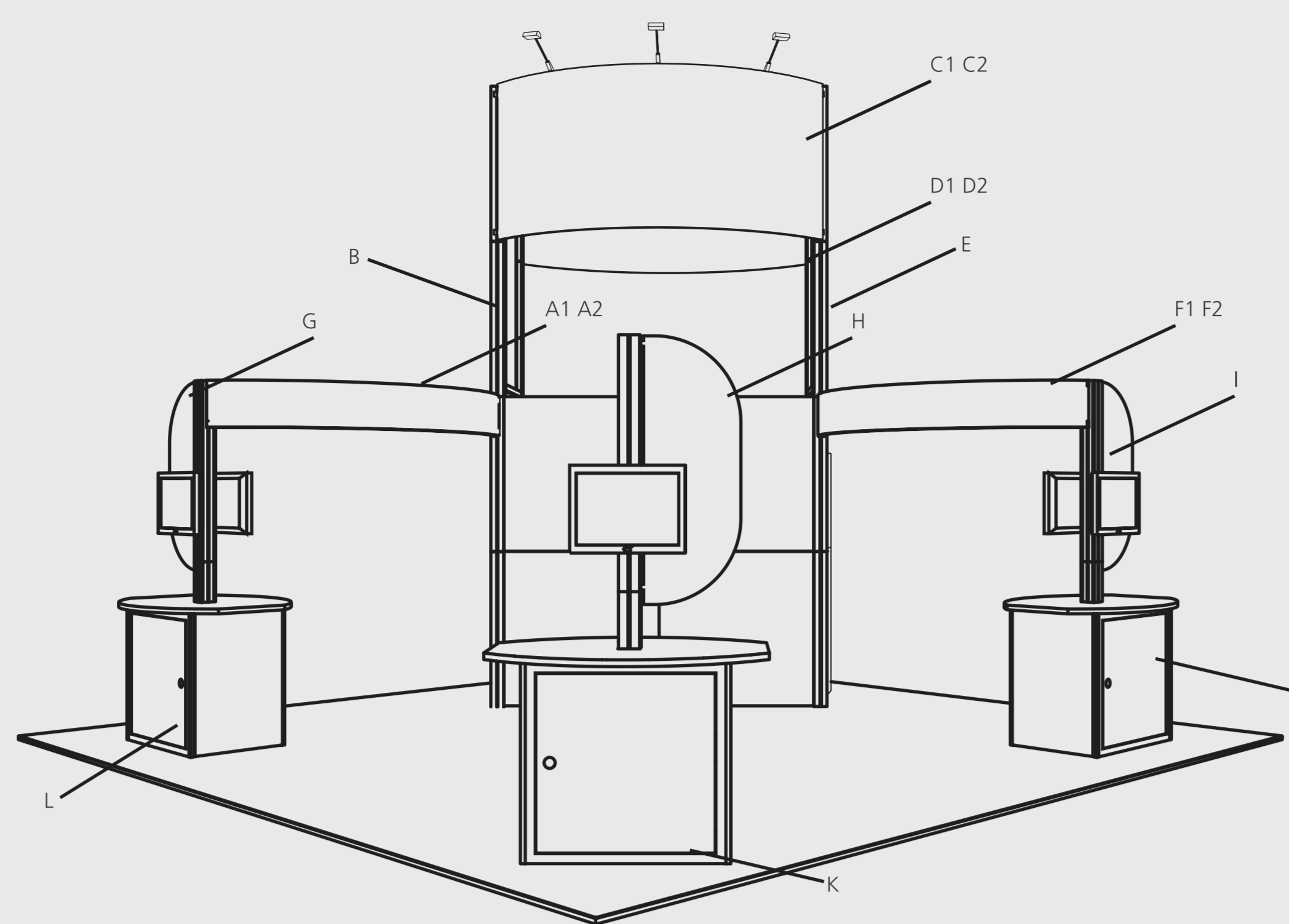

PANEL M

PANEL N

bleed area —
trim line —
safe zone —