

Formulate Master Tabletop Display TT4

Formulate Tabletop displays are lightweight, highly-portable and come in straight or vertically curved options. The frame assembles with easy-to-use snap buttons, then simply pull the pillowcase fabric graphic over the frame and zip. Stretch fabric graphics are hand-sewn, durable and dry-cleanable.

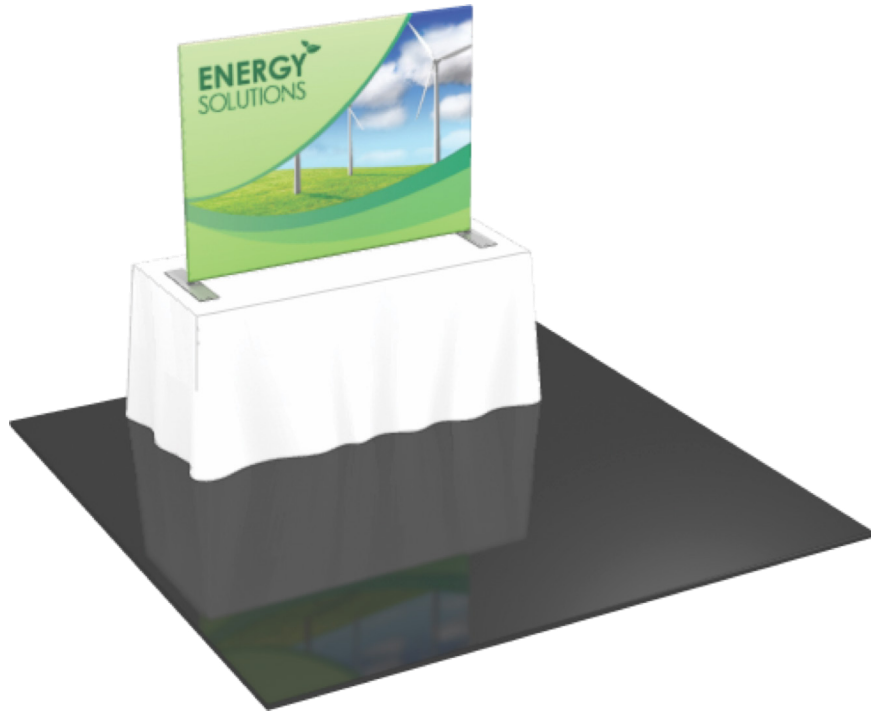

features and benefits:

- State-of-the-art 30mm aluminum tube frame with snap button assembly
- Fits on a 6ft wide table
- Easy to store and ship
- Quick to assemble
- Kit includes: one frame, one dye-sublimated zipper pillowcase graphic, and one wheeled molded storage case
- Lifetime hardware warranty against manufacturer defects

dimensions:

Hardware

Assembled unit:
64.72" w x 46.81" h x 17.72" d
1644mm(w) x 1189mm(h) x 450mm(d)

Approximate weight:
16 lbs / 8 kg

Graphic

Refer to related graphic template for more information.

Visit:
www.tradeshowplus.com

Shipping

Packing case(s):
1 OCS

Shipping dimensions:
45" l x 19" h x 19" d
1143mm(l) 483mm(h) x 483mm(d)

Approximate shipping weight (with case):
35 lbs / 16 kg

additional information:

Graphic material:
dye-sublimated zipper pillowcase fabric

*Backside can be upgraded to print

We are continually improving and modifying our product range and reserve the right to vary the specifications without prior notice. All dimensions and weights quoted are approximate and we accept no responsibility for variance. E&OE. See Graphic Templates for graphic bleed specifications.

Included In Your Kit

Tools, Components, & Connectors



6MM HEX KEY x1

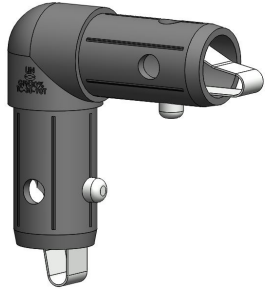

TC-30-90 x2

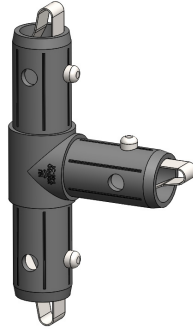

TC-30-T x2

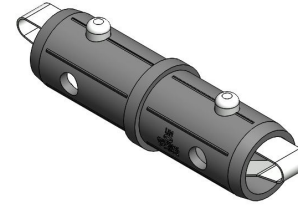

TC-30-S x3

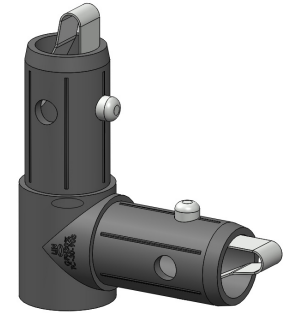

TC-30-90B x2



WTT-S01-T1 x4

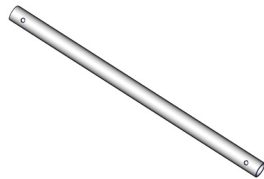

WTT-S01-T2 x6

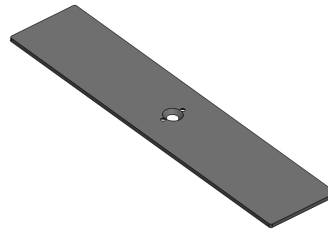

PLT-BP-LN114-S2-450 x2

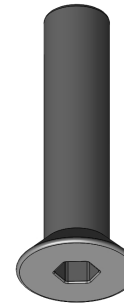

LN114-SCRW x2

Graphics



FMLT-WTT-S01-G x1

Exploded View

FMLT-WTT-S01

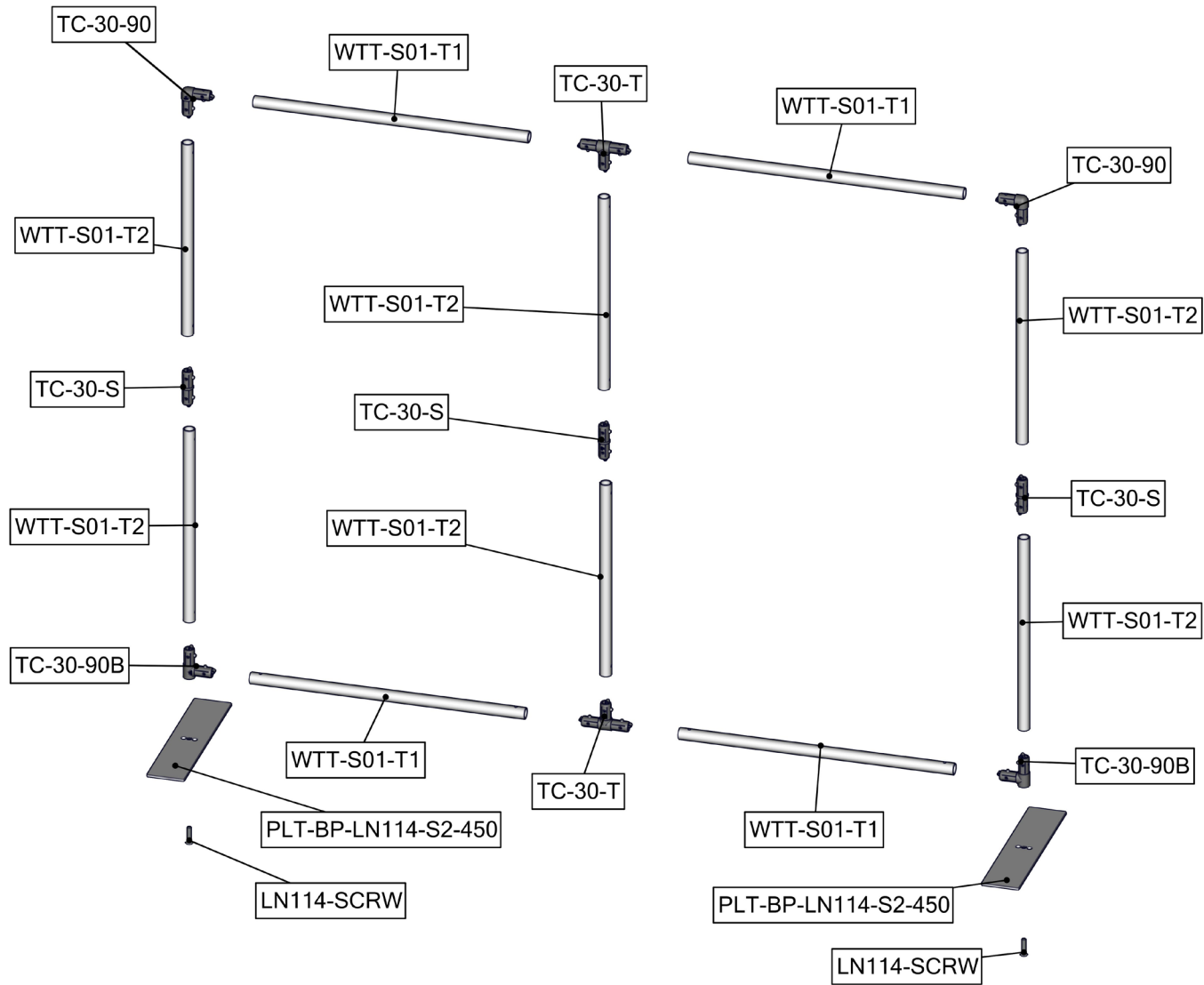

Labeling Diagram

FMLT-WTT-S01

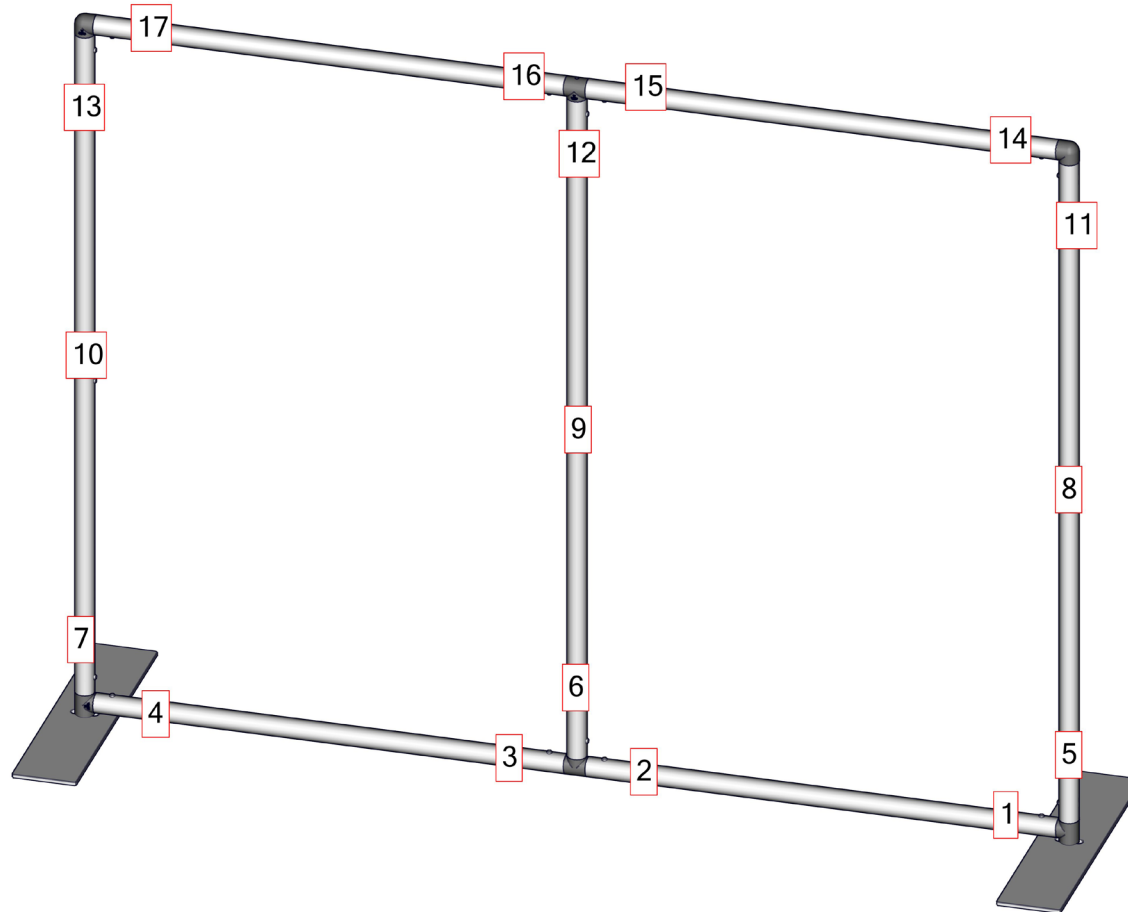

Connection Methods

Connection Method 1: TC-30-90B

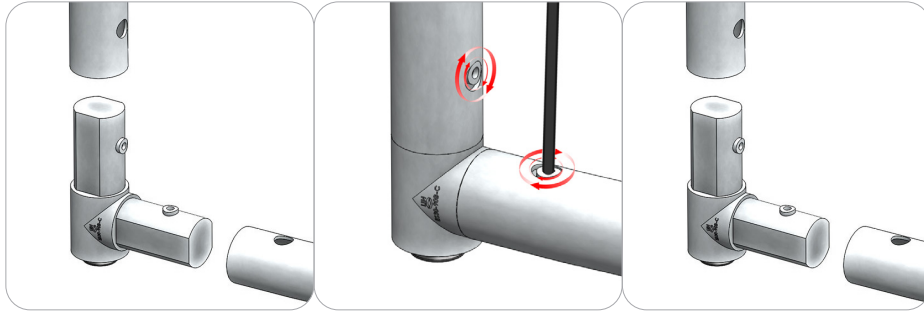

Compress one unlocked end of the connector and slide it through one tube end. Compress the other end of the connector and slide the second tube on. Lock both screws carefully using your allen key tool. Be sure to lock securely, but do not over tighten.

Connection Method 2: PLT-BP-LN114-S2-450

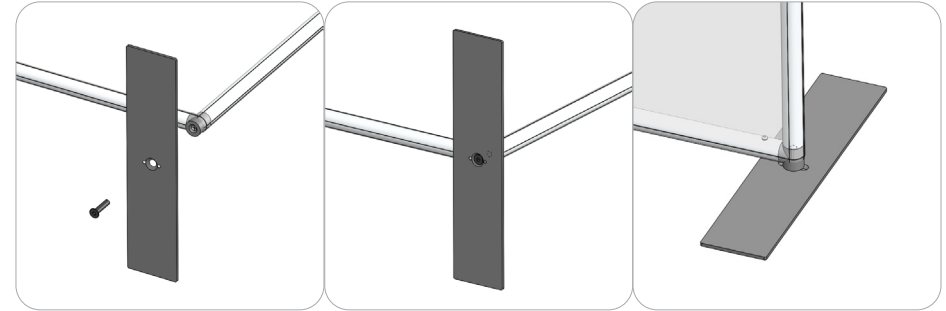

First, Align the screw hole on the foot with the hole on the frame. Second, slide the screw into the holes and tighten it with the allen key. Do not over tighten.

Kit Assembly

Step by Step

Step 1.

Gather the components to build the frame. Use the Exploded View and the Labeling Diagram for part labels.

Reference Connection Method 1 for more details.

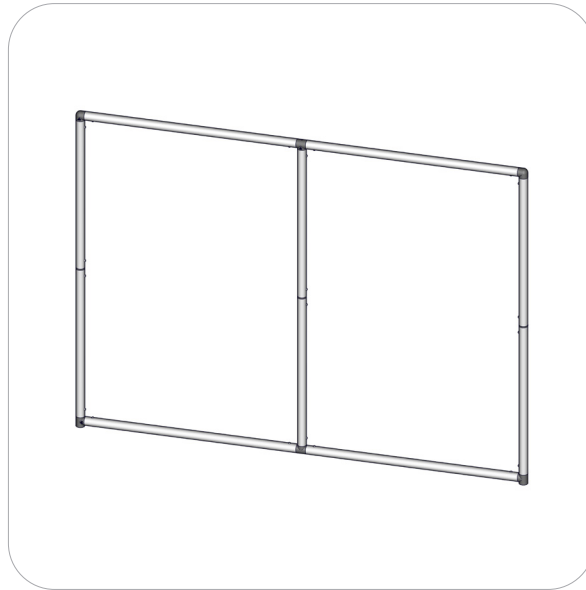

Step 2.

Once the frame is connected, attach the feet. Secure feet to the bottom of the frame by tightening the screws.

Reference Connection Method 2 for more details.

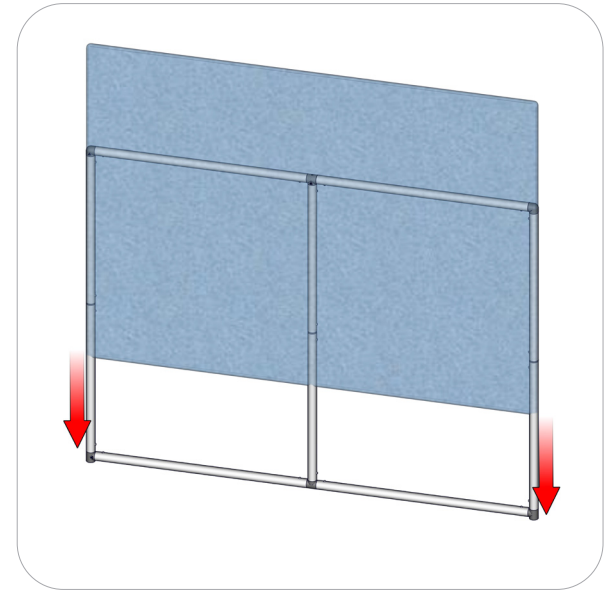
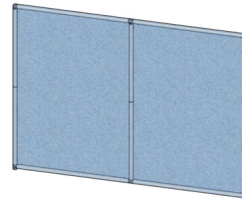

Step 3.

Slide the graphic over the top end of the frame and zip the fabric close on the bottom of the frame.

Setup is complete

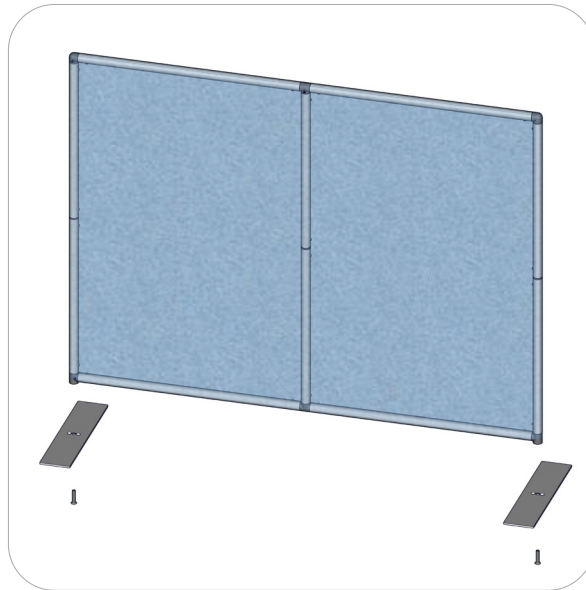
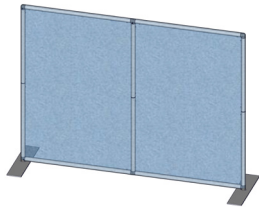

Check out these related products:

Formulate® Tabletop displays are lightweight, highly-portable and come in straight or vertically curved options. The frame assembles with easy-to-use snap buttons, then simply pull the pillowcase fabric graphic over the frame and zip. Stretch fabric graphics are hand-sewn, durable and dry-cleanable.



Formulate 8ft Kits



Formulate 10ft Kits
(Horizontal Curve)



Formulate 10ft Kits
(Vertical Curve)



Formulate 10ft Kits
(Straight)



Formulate 20ft Kits



Formulate Hanging Structures