

Formulate Fusion 20x20 Island Kit 08

Formulate Fusion provides an unparalleled dynamic that elevates and accentuates a message and brand, but also maximizes the return on trade show investment. Formulate Fusion is Origin's collection of 20ft x 20ft exhibit kits and custom solutions. A fusion of FORM, FABRIC and FUNCTION, these kits combine organic and architectural shapes with state-of-the-art zipper pillowcase dye-sublimated fabric graphics to create unique, dynamic and functional island space.



features and benefits:

- 30mm and 50mm aluminum tube frames
- 12 back-lit dye-sublimated silicone edge push-fit fabric graphics
- Counter tops available in four thermoformed finishes, shown below
- Kit includes multi layered frames, dye-sublimated pillowcase graphics, six LED light boxes, a conference room and one counter
- Lifetime hardware warranty against manufacturer defects

dimensions:

Hardware

Assembled unit:

239.7" w x 190.1" h x 239.9" d
6087mm(w) x 4828mm(h) x 6093mm(d)

Approximate weight with cases:

1549 lbs / 702.6 kgs

Shipping

Packing case(s):

1 WOODCRATE-H Case
2 OCE Cases

Shipping dimensions:

WOODCRATE-H: 101"l x 53" w x 49" h
2566mm(l) x 1347mm(w) x 1245mm(h)

OCE: Expandable case length (l) may vary

40" - 66"l x 18" w x 18" h
1016mm-1677mm(l) x 458mm(w) x 458mm(h)

Approximate total shipping weight
(includes cases & graphics):

1583.8 lbs / 718.4kgs

Graphic

Refer to related graphic template for more information.

Visit:

www.tradeshowplus.com

additional information:

Graphic material:
dye-sublimation zipper pillowcase fabric

*Monitors and flooring not included

Counter top Dimensions:

47" w x 1.18" h x 23" d
Counter top Max Weight Capacity: 25 lbs.

Wood Finish Options



silver

black

mahogany

natural

We are continually improving and modifying our product range and reserve the right to vary the specifications without prior notice. All dimensions and weights quoted are approximate and we accept no responsibility for variance. E&OE. See Graphic Templates for graphic bleed specifications.

Included In Your Kit

Tools, Components, & Connectors



ALLEN KEY SET x2



CFAB-K-08-A-P1 x4



ES50 x102



ES30 x34



LIGHT-FLL440 x12



LIGHT-FL3LC6 LINK CABLE x10



LIGHT-FL3PC6 POWER CORD x2



CH-ID-LD-01 x2



EYEBOLT-5/16-18 x2



LN114-SCRW x4



BASE-CFAB-K-08-D-1 x2



BASE-CFAB-K-08-D-2 x2



BASE-CFAB-K-08-D-3 x4



BASE-CFAB-K-08-D-4 x2

Included In Your Kit

Tools, Components, & Connectors



PHFC4-750-GR-MCB9-MCB9-SIDE x12



PHFC4-750-MCB9-MCB9 x12

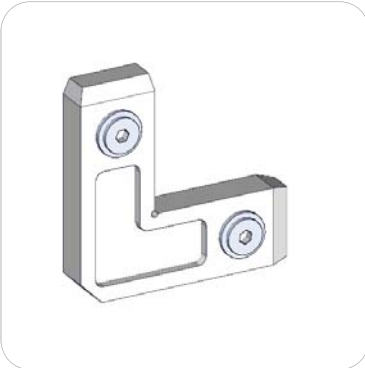

CB9 x24



WME-300 x12



LED-DB-PWRCORD x4

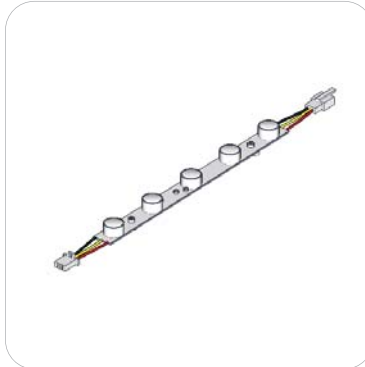

LED-WHT-DB-300 x24

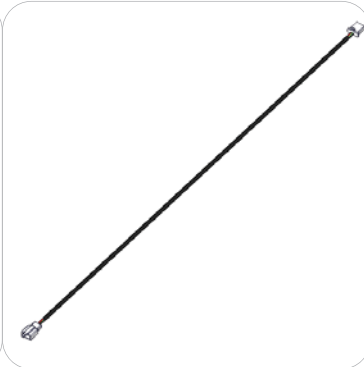

LED-DB-CL-300 x8



LED-DB-CL-800 x12



LED-DB-CL-DCJ-600 x4

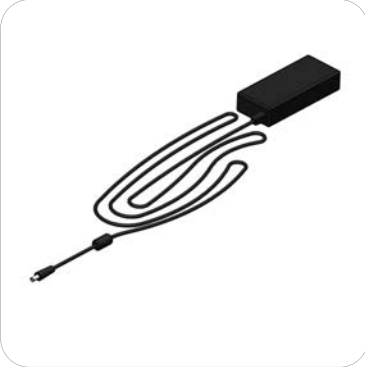

LED-DB-PWRSUPPLY x4

Graphics



CFAB-K-08-A-G-1 x1



CFAB-K-08-A-G-2 x2
CFAB-K-08-A DIFFUSER PANEL x4



CFAB-K-08-B-G-1 x2



CFAB-K-08-C-G-1 x1

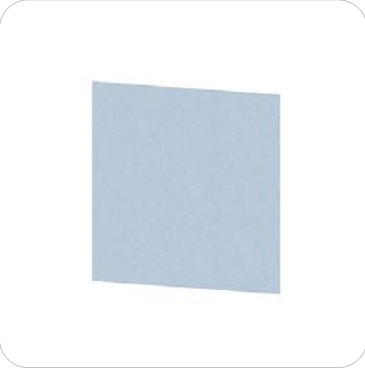

CFAB-K-08-D-G-1 x12

Included In Your Kit

Tubes



CFAB-K-08-A-T1 x2



CFAB-K-08-A-T2 x2



CFAB-K-08-A-T3 x2



CFAB-K-08-A-T4 x2



CFAB-K-08-A-T5 x2



CFAB-K-08-A-T6 x2



CFAB-K-08-A-T7 x2



CFAB-K-08-A-T8 x2



CFAB-K-08-A-T9 x2



CFAB-K-08-A-T10 x2



CFAB-K-08-A-T11 x2



CFAB-K-08-A-T12 x2



CFAB-K-08-A-T13 x2



CFAB-K-08-A-T14 x2



CFAB-K-08-A-T15 x2

Included In Your Kit

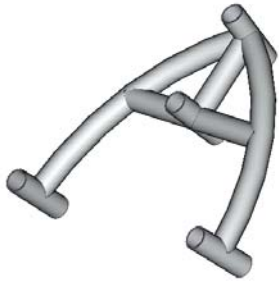

CFAB-K-08-A-T16 x2



CFAB-K-08-A-T17 x2



CFAB-K-08-A-T18 x2



CFAB-K-08-A-T19 x2



CFAB-K-08-A-T20 x2

Tubes

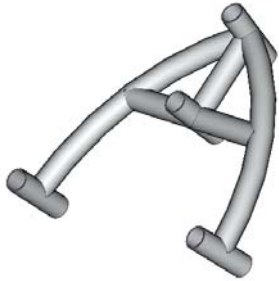

CFAB-K-08-A-T21 x2



CFAB-K-08-A-T22 x2



CFAB-K-08-A-T23 x2



CFAB-K-08-A-T24 x2



CFAB-K-08-A-T25 x2



CFAB-K-08-A-T26 x2



CFAB-K-08-A-T27 x2



CFAB-K-08-A-T28 x2



CFAB-K-08-A-T29 x2



CFAB-K-08-A-T30 x2

Included In Your Kit

Tubes



CFAB-K-08-B-T1 x2



CFAB-K-08-B-T2 x4



CFAB-K-08-B-T3 x8



CFAB-K-08-B-T4 x4

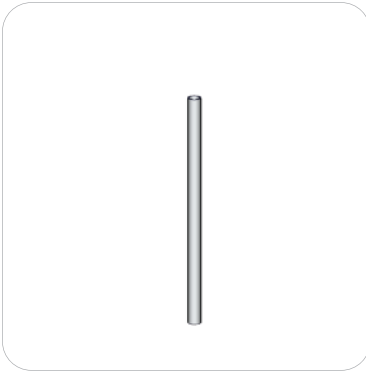

CFAB-K-08-C-T1 x2



CFAB-K-08-C-T2 x2



CFAB-K-08-C-T3 x4



CFAB-K-08-C-T4 x2



CFAB-K-08-D-T1 x4



CFAB-K-08-D-T2 x4



CFAB-K-08-D-T3 x2



CFAB-K-08-A-T31 x1

Exploded View

CFAB-K-08

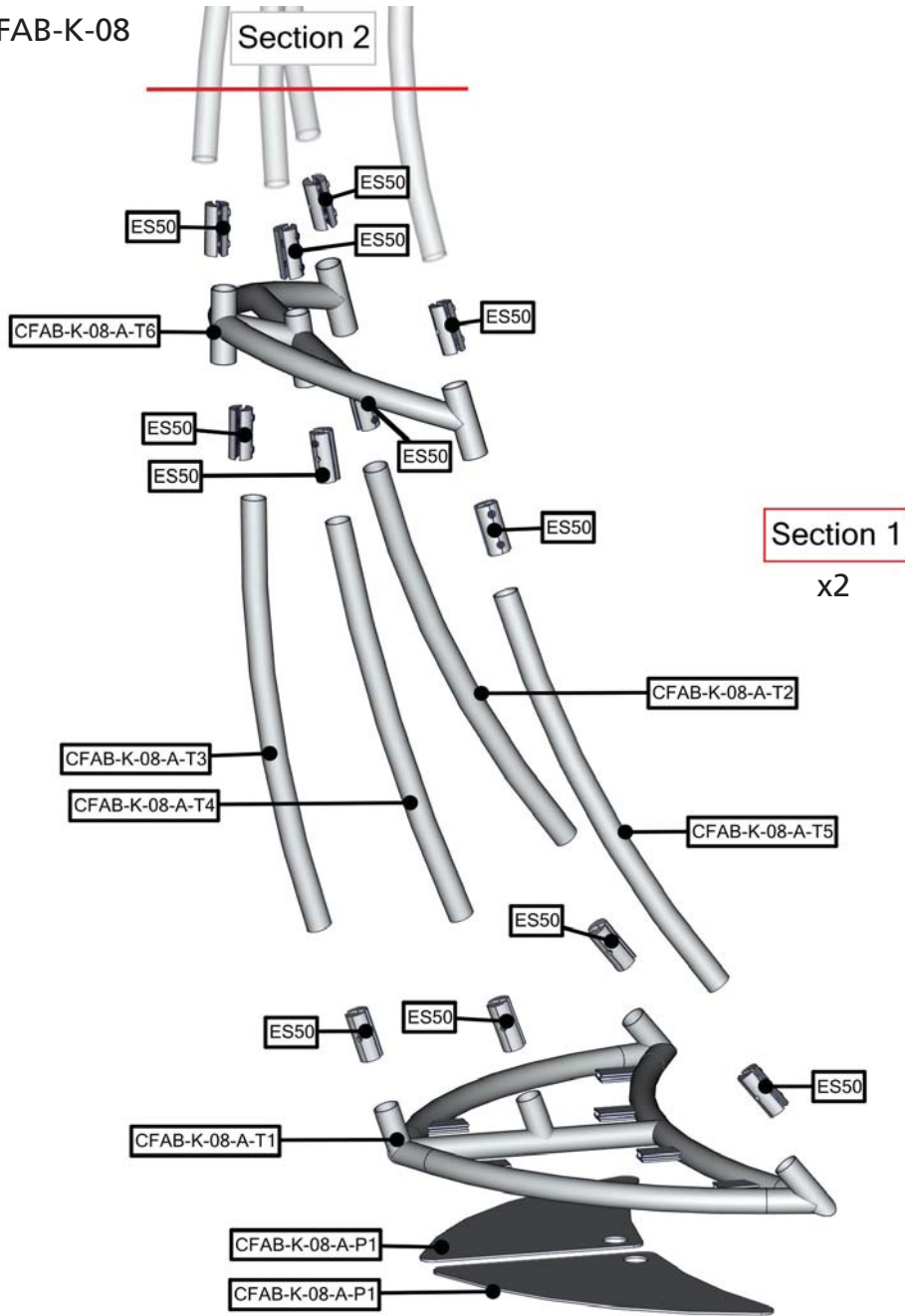

Section 1
x2

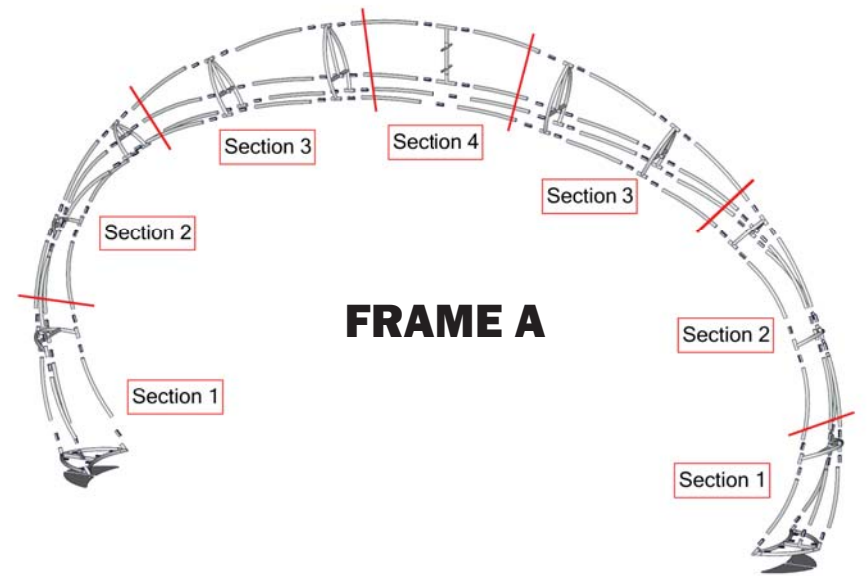

Exploded View

CFAB-K-08

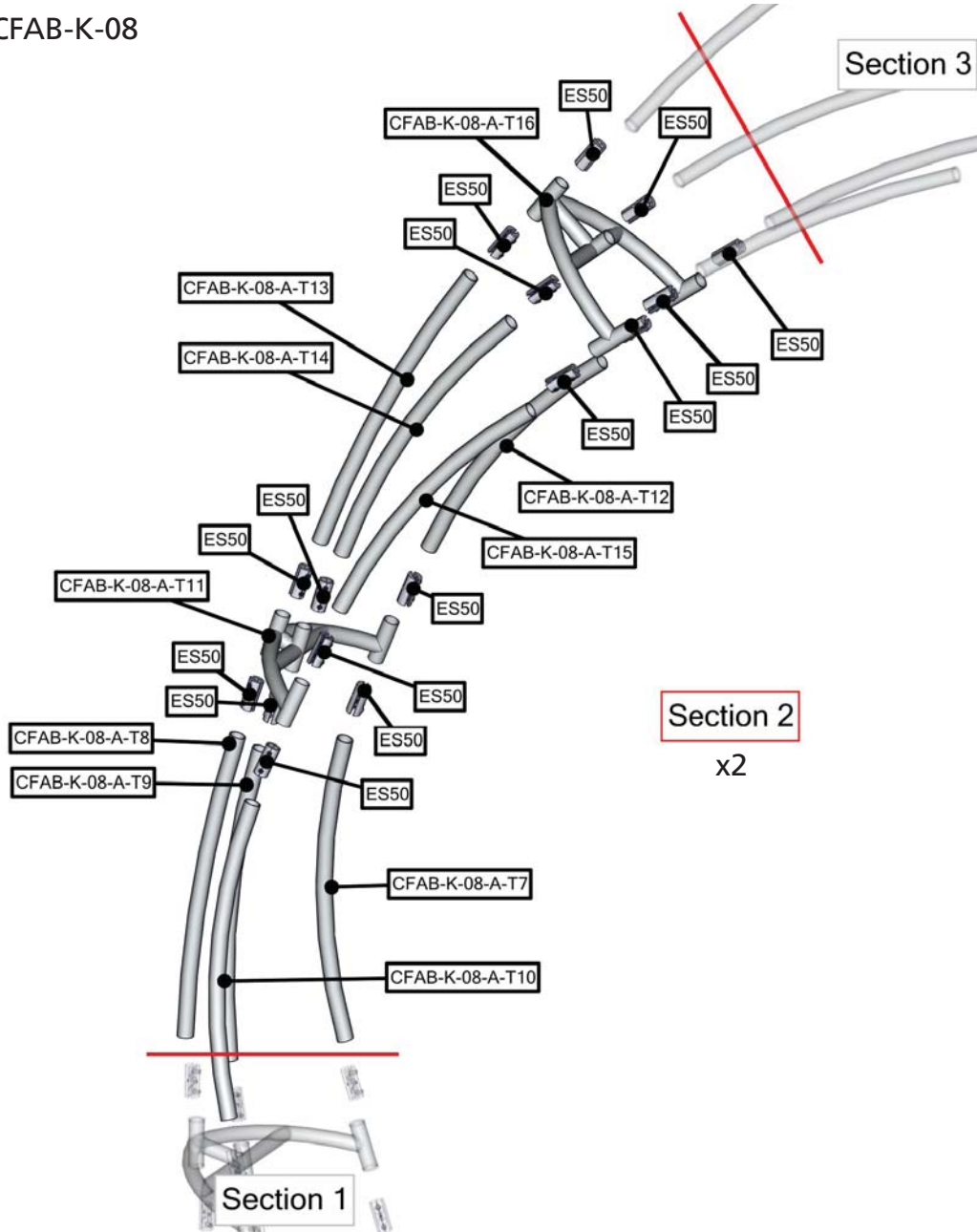

Section 2
x2

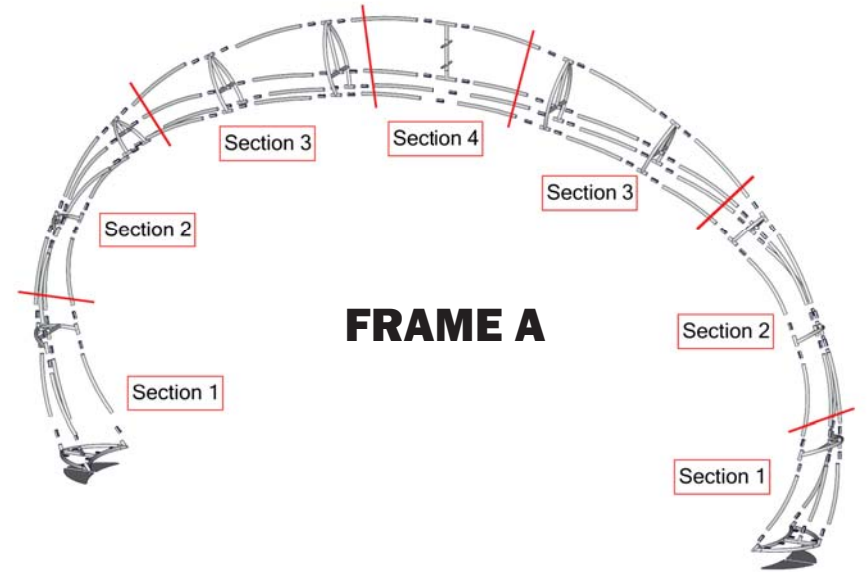

Exploded View

CFAB-K-08

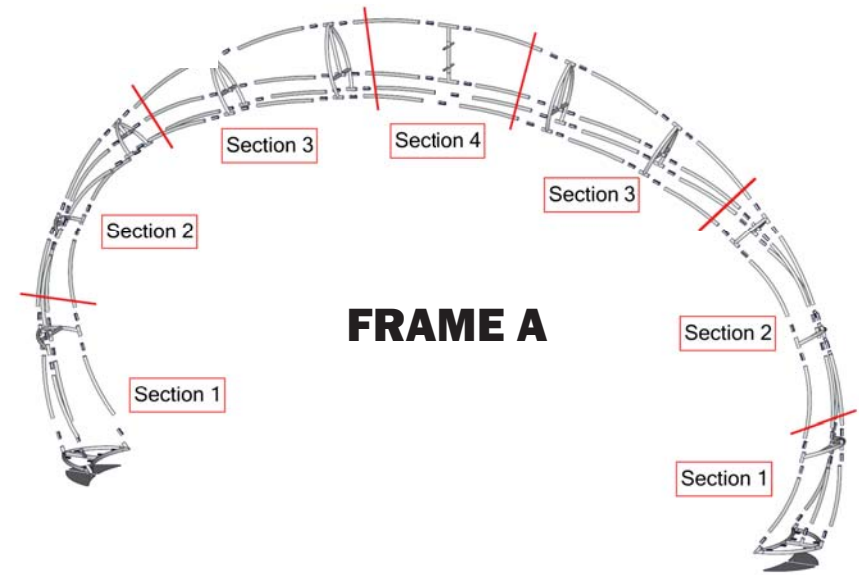
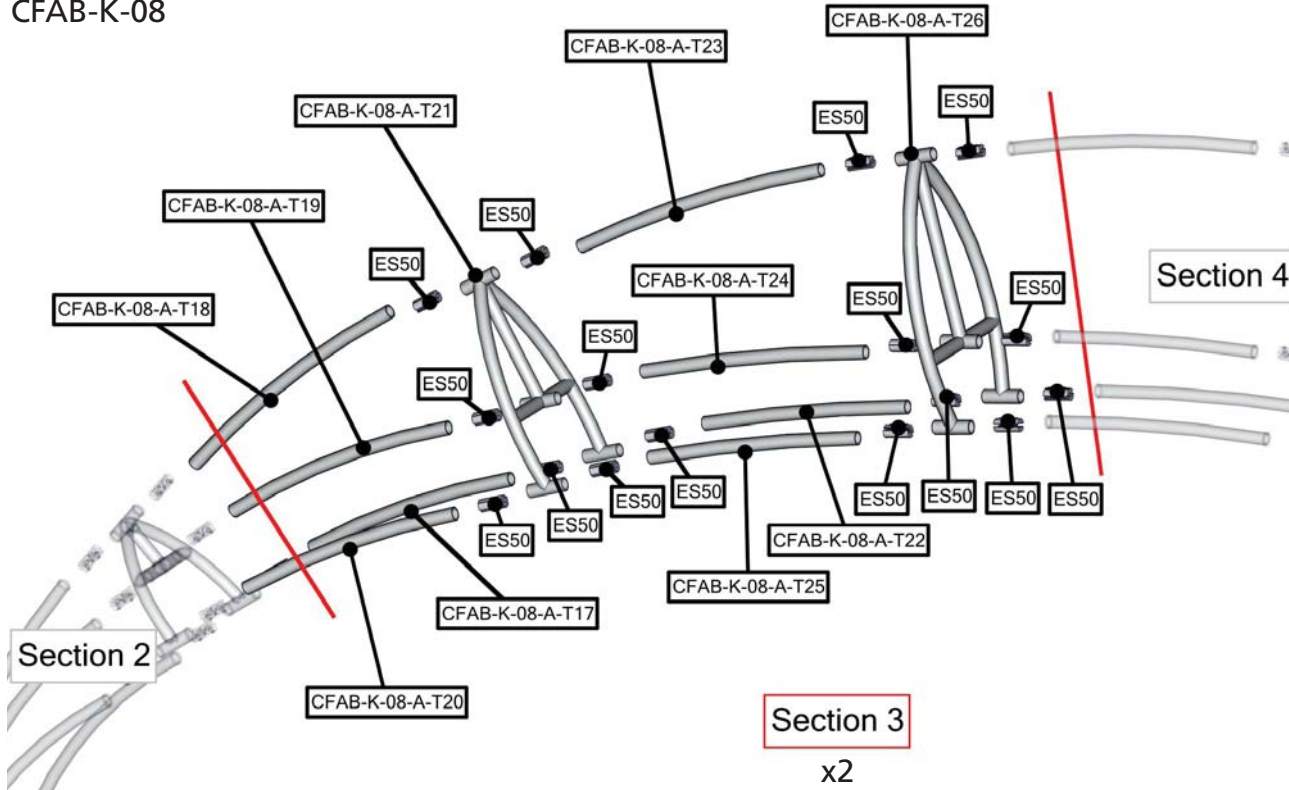

Exploded View

CFAB-K-08

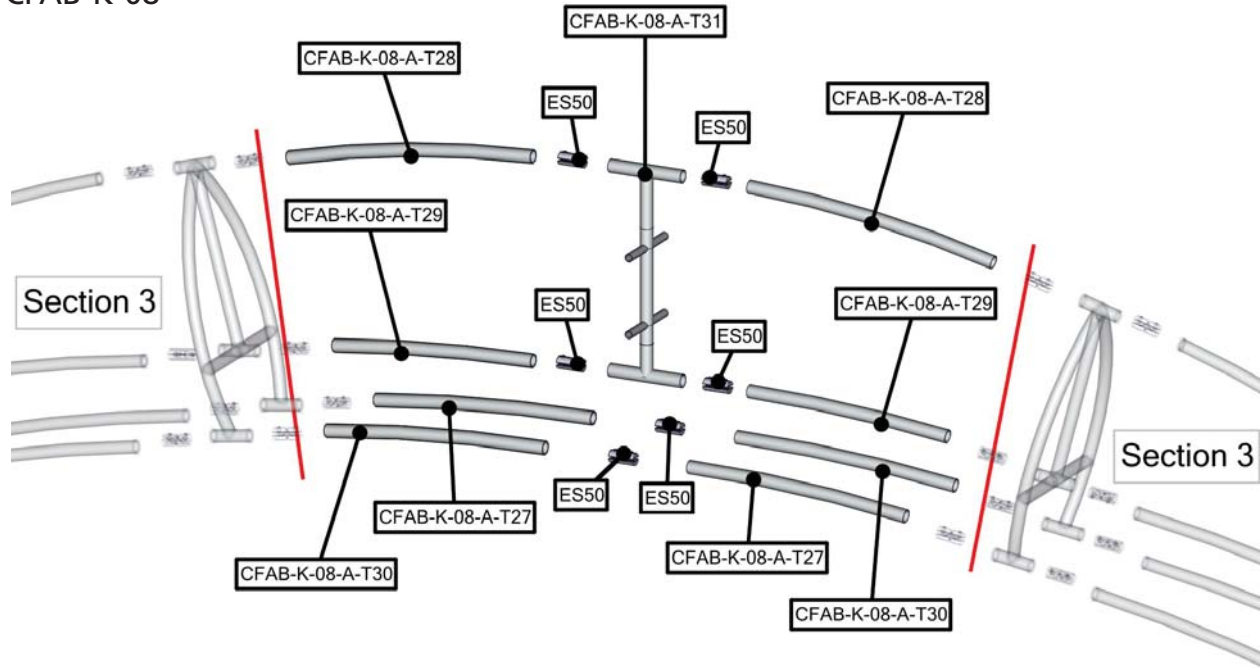

Section 4

x1

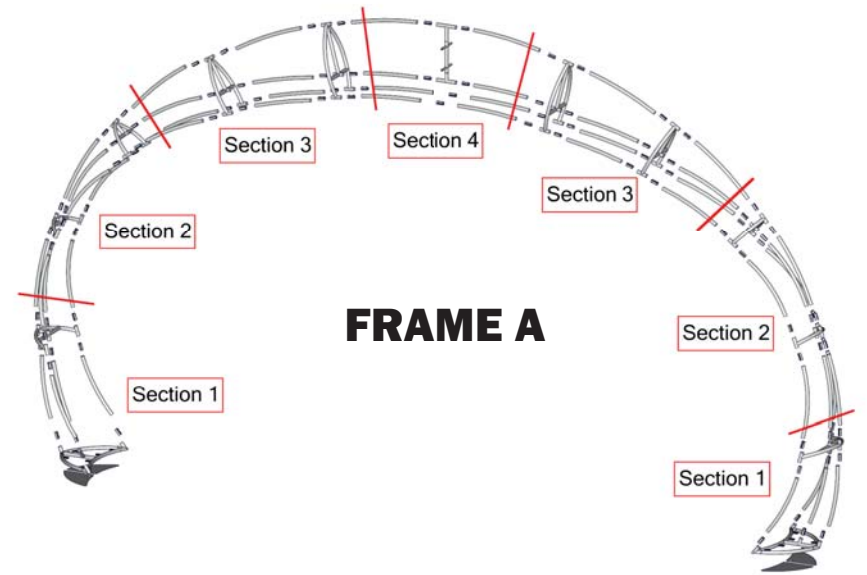

Labeling Diagram

CFAB-K-08

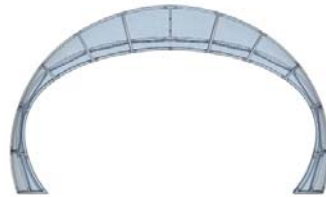
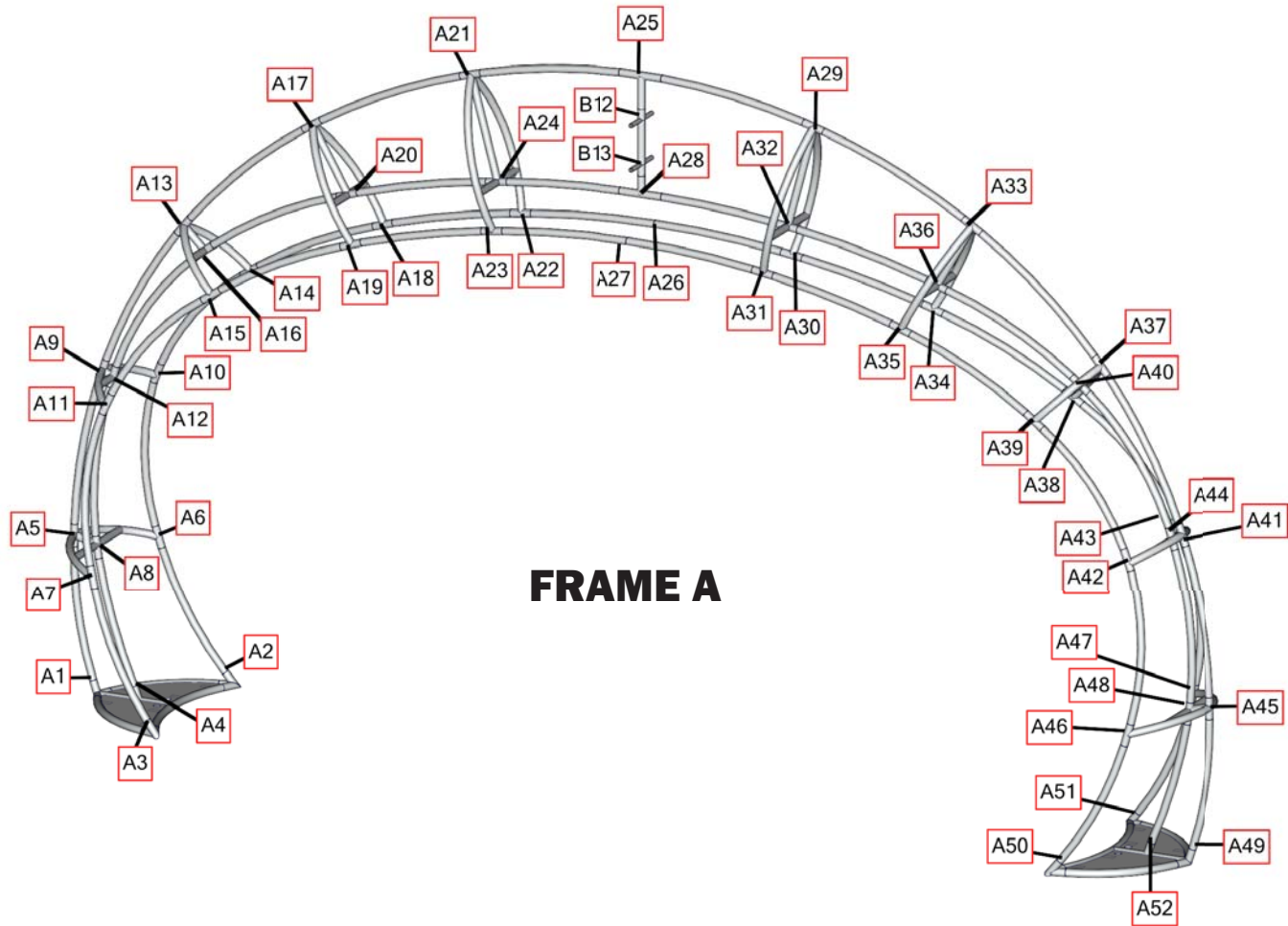

Internal Lighting Setup

CFAB-K-08

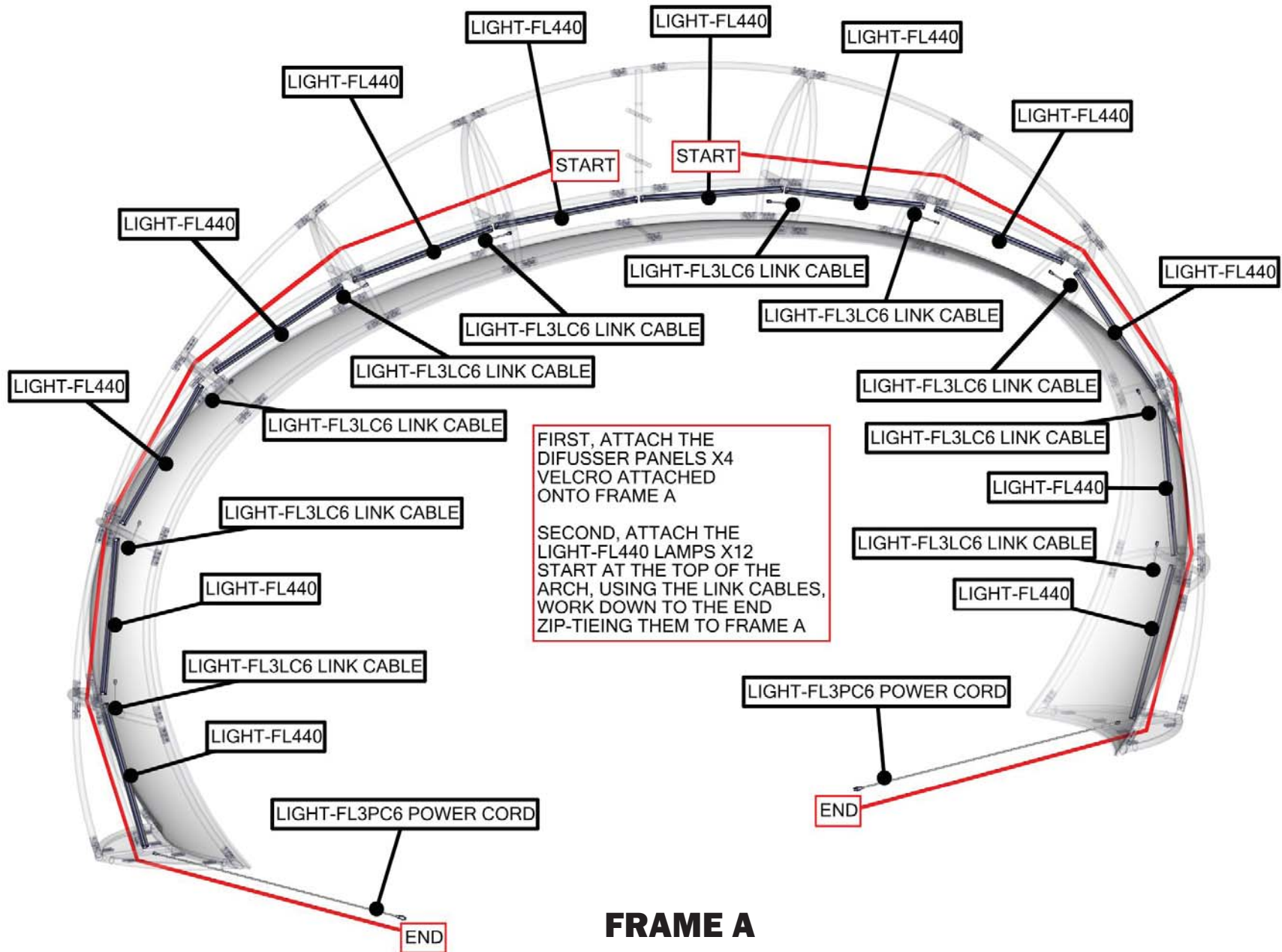

Exploded View

CFAB-K-08

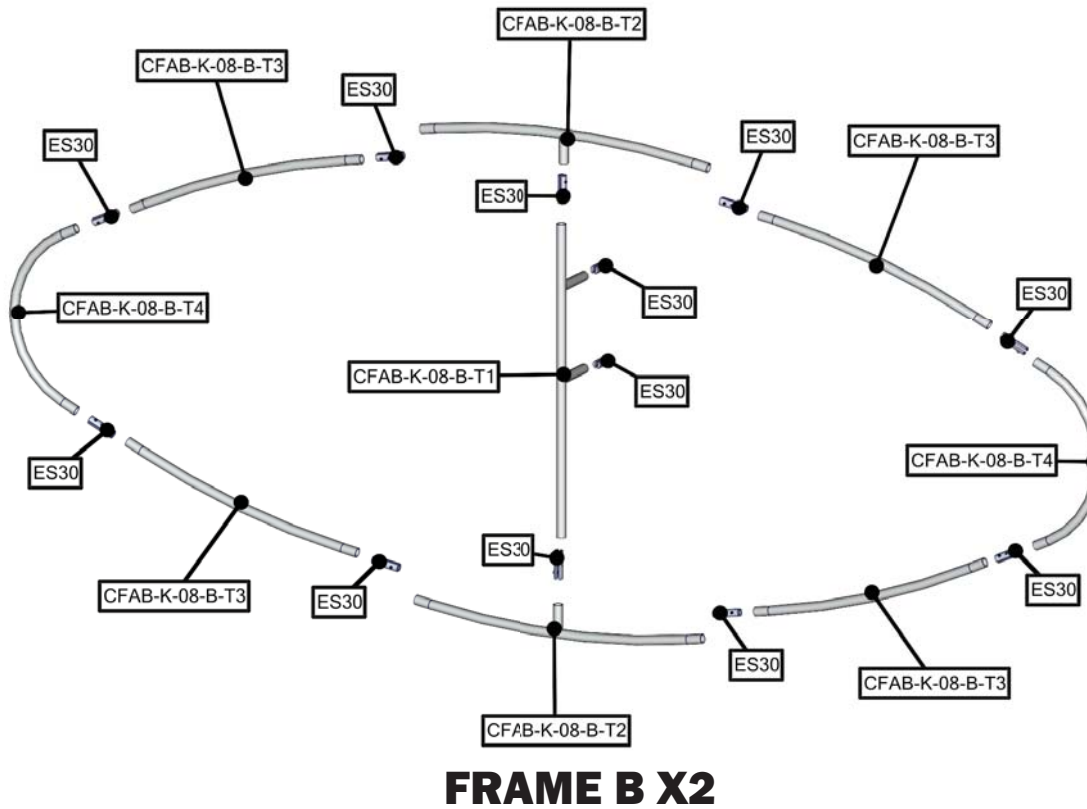

Labeling Diagram

CFAB-K-08

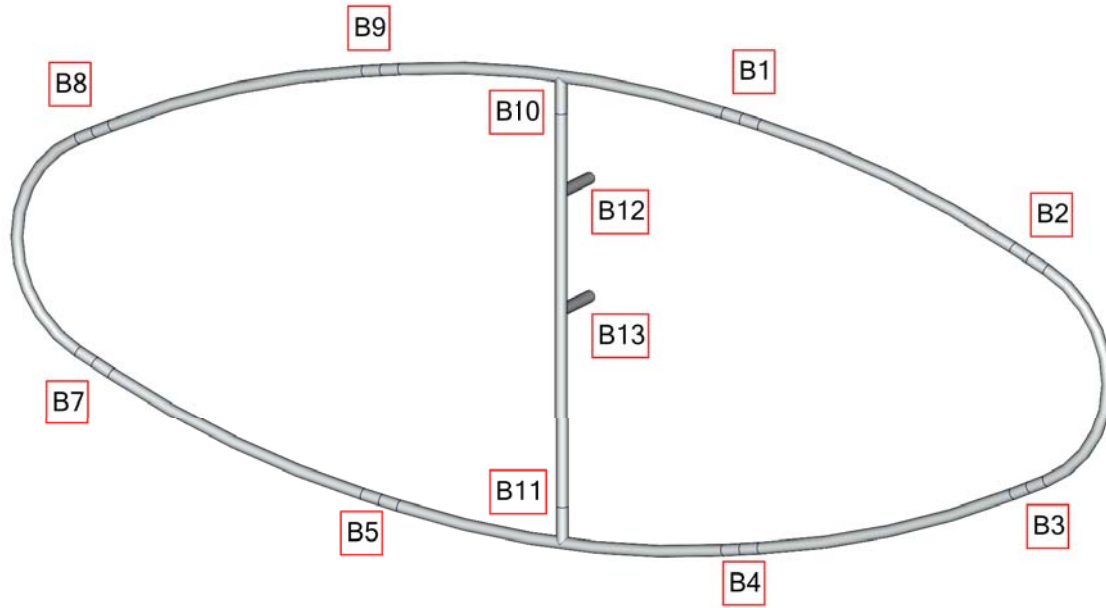

FRAME B X2

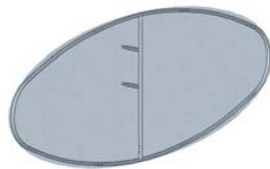

Exploded View

CFAB-K-08

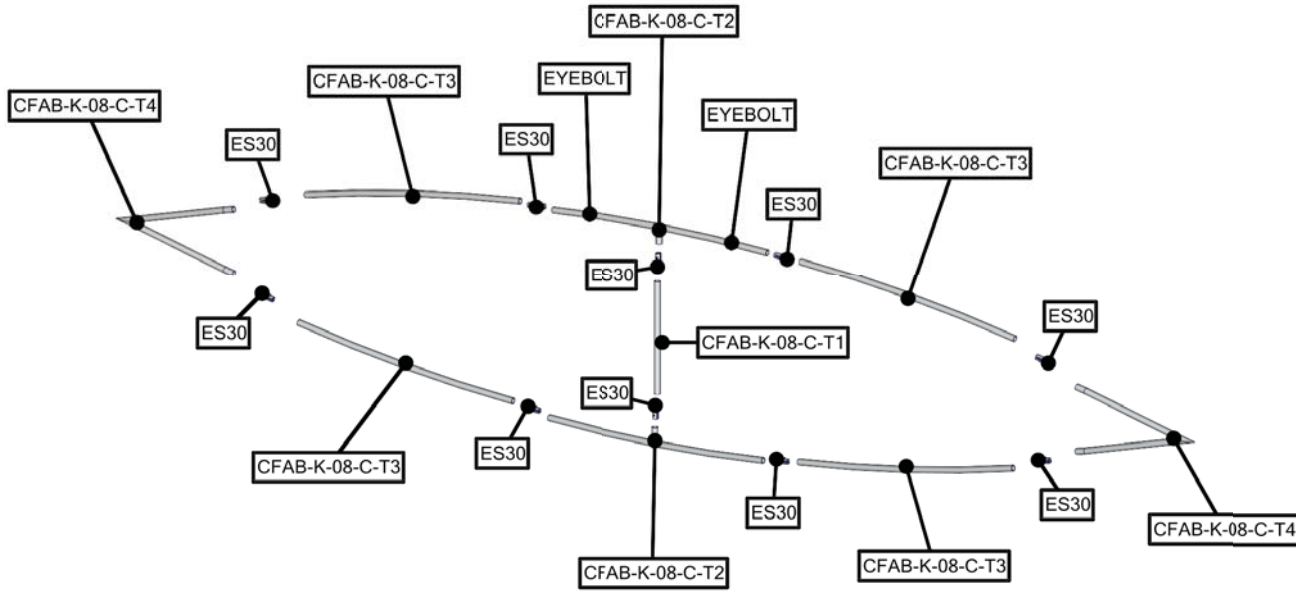

FRAME C

Labeling Diagram

CFAB-K-08

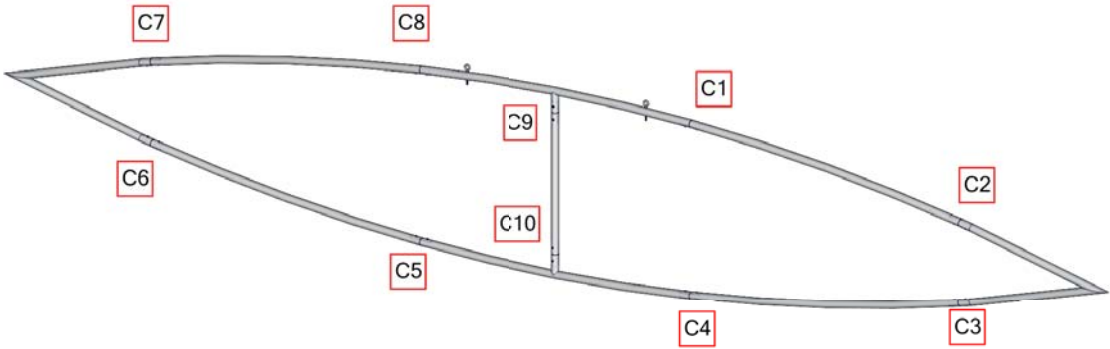

FRAME C

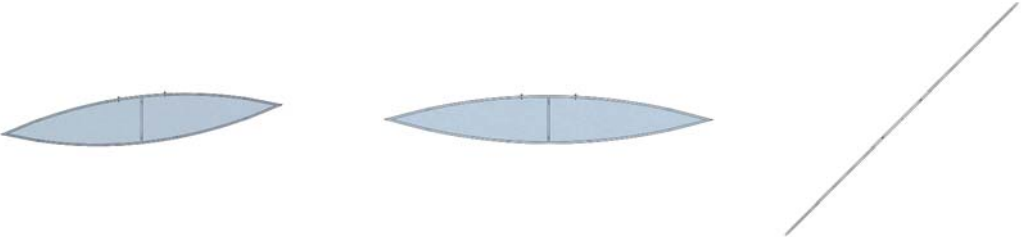

Exploded View

CFAB-K-08

FRAME D x2

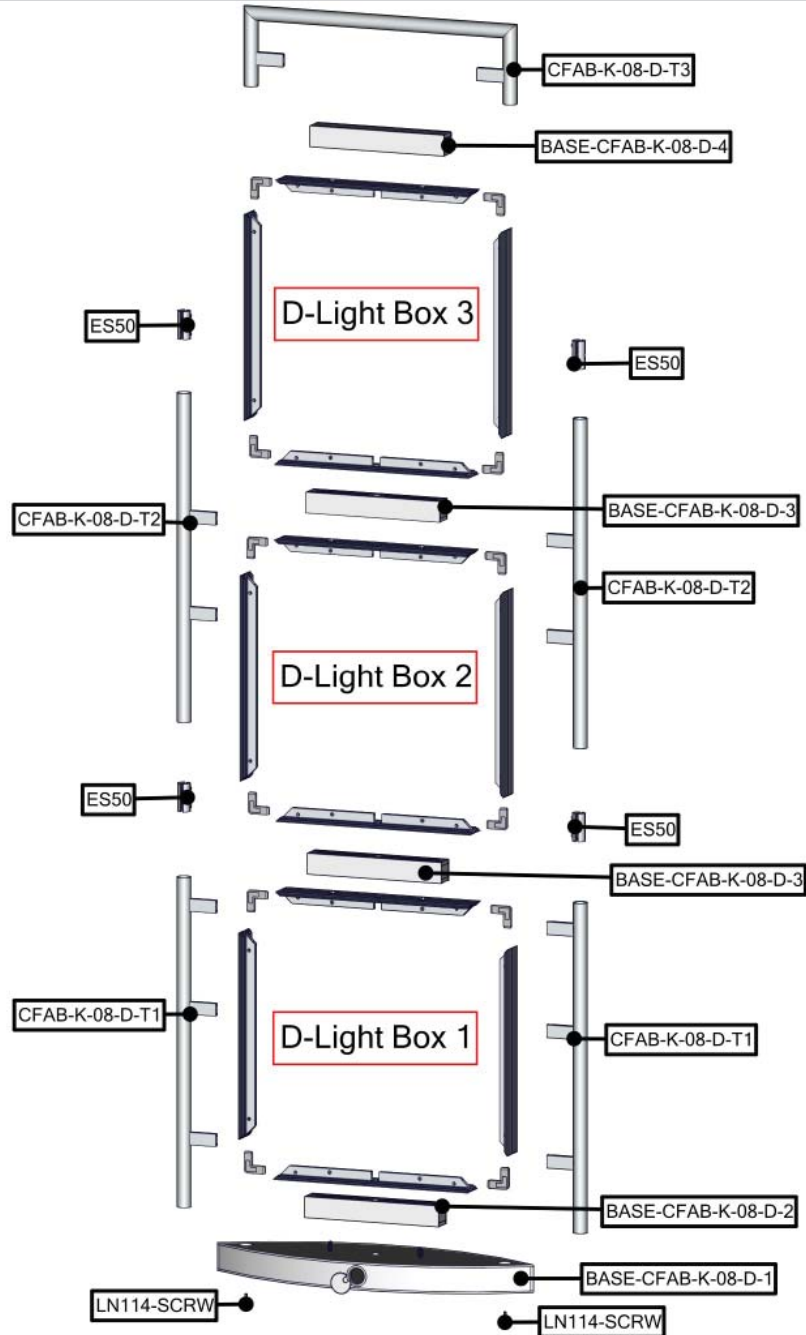

Exploded View

CFAB-K-08

FRAME D x2

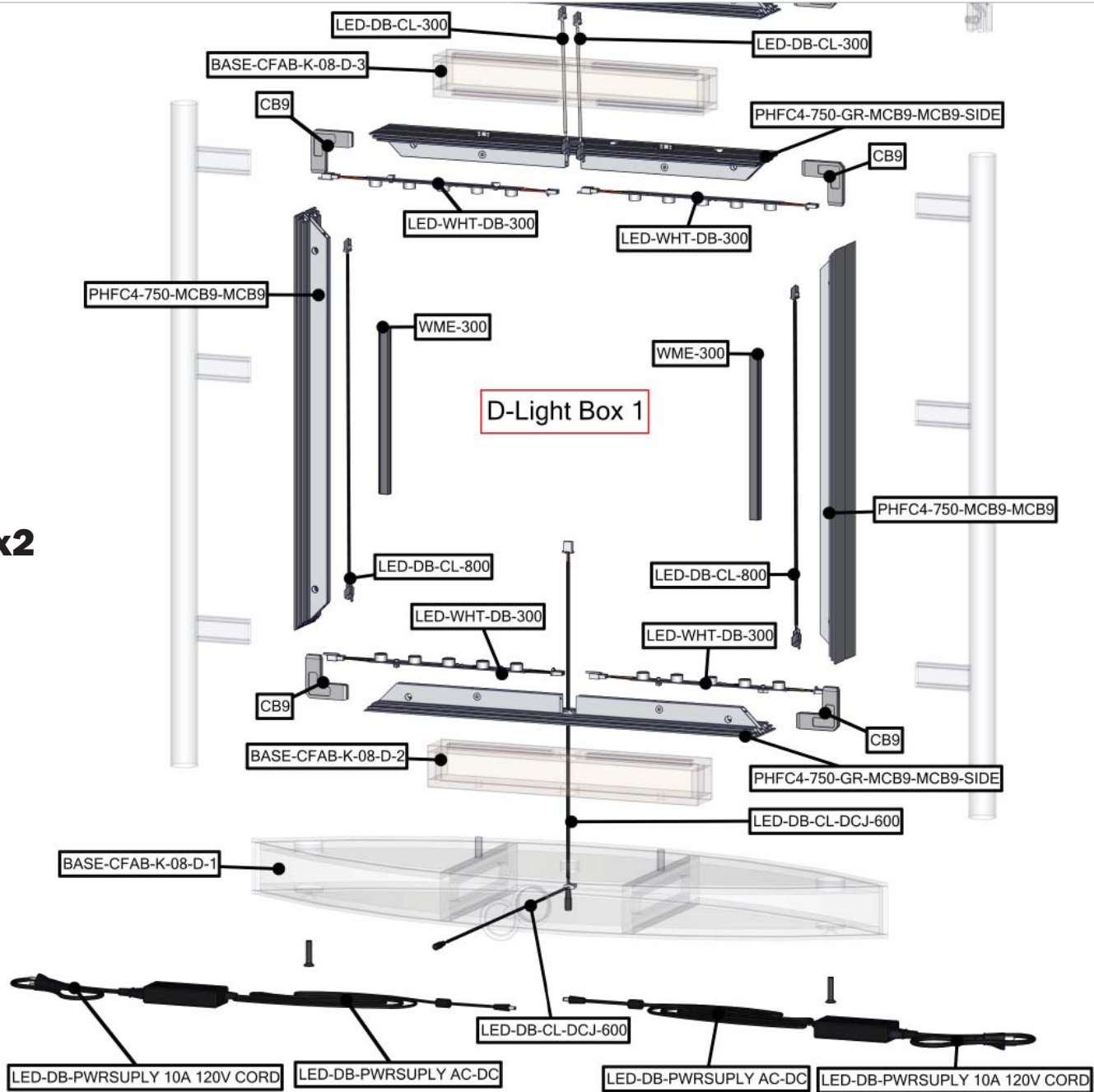

Exploded View

CFAB-K-08

FRAME D x2

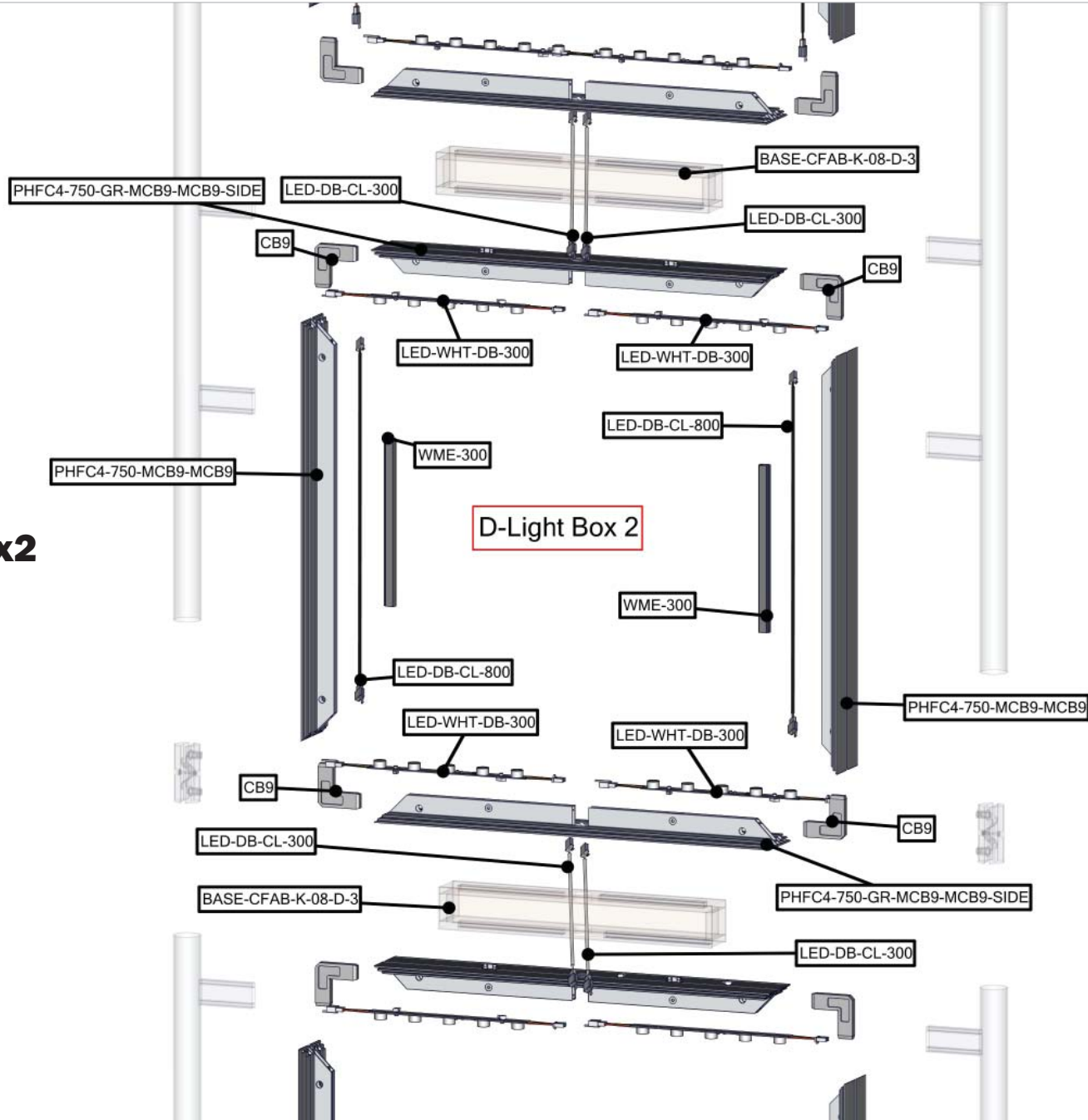

Exploded View

CFAB-K-08

FRAME D x2

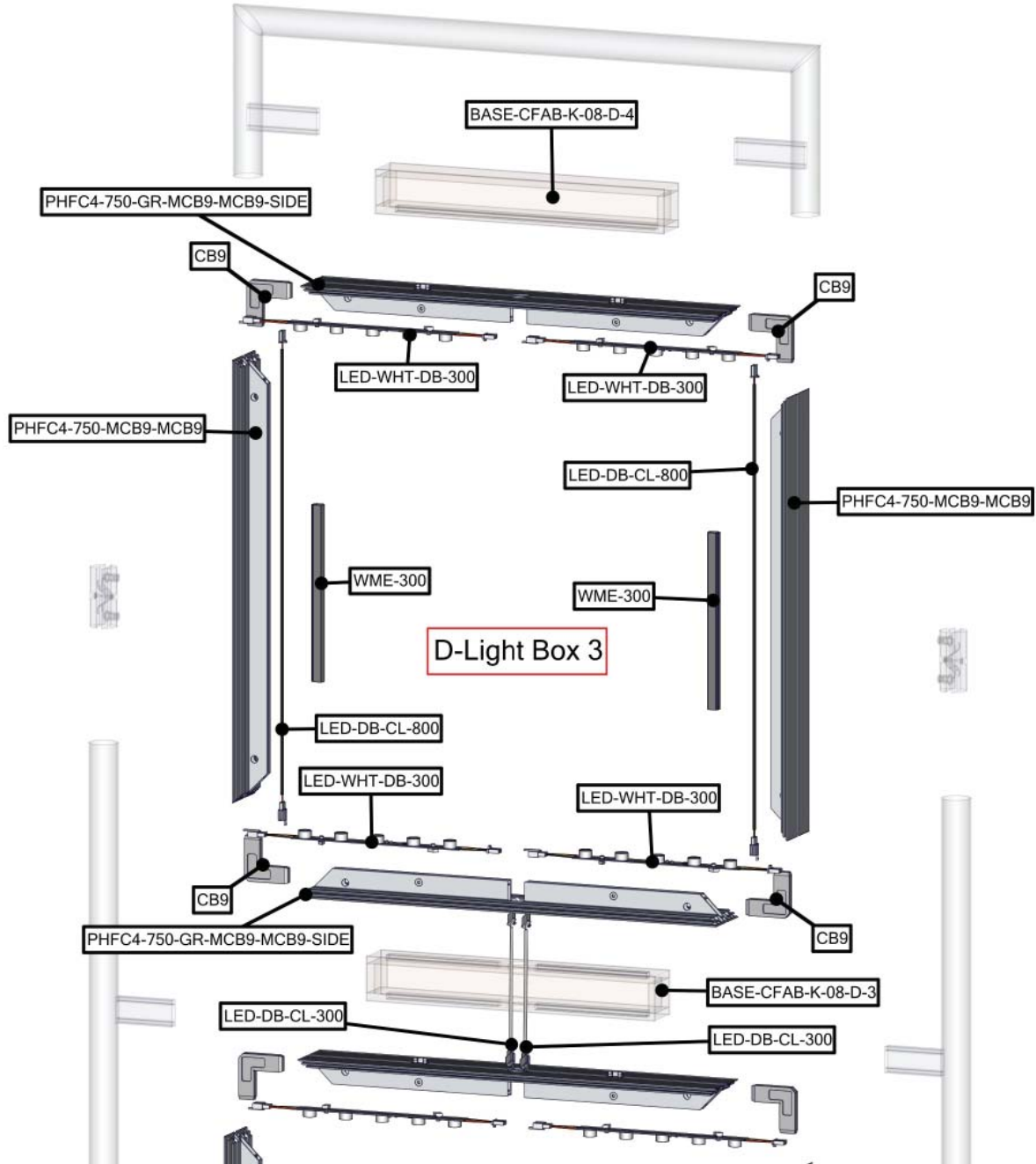

Internal Lighting Setup

CFAB-K-08

FRAME D x2

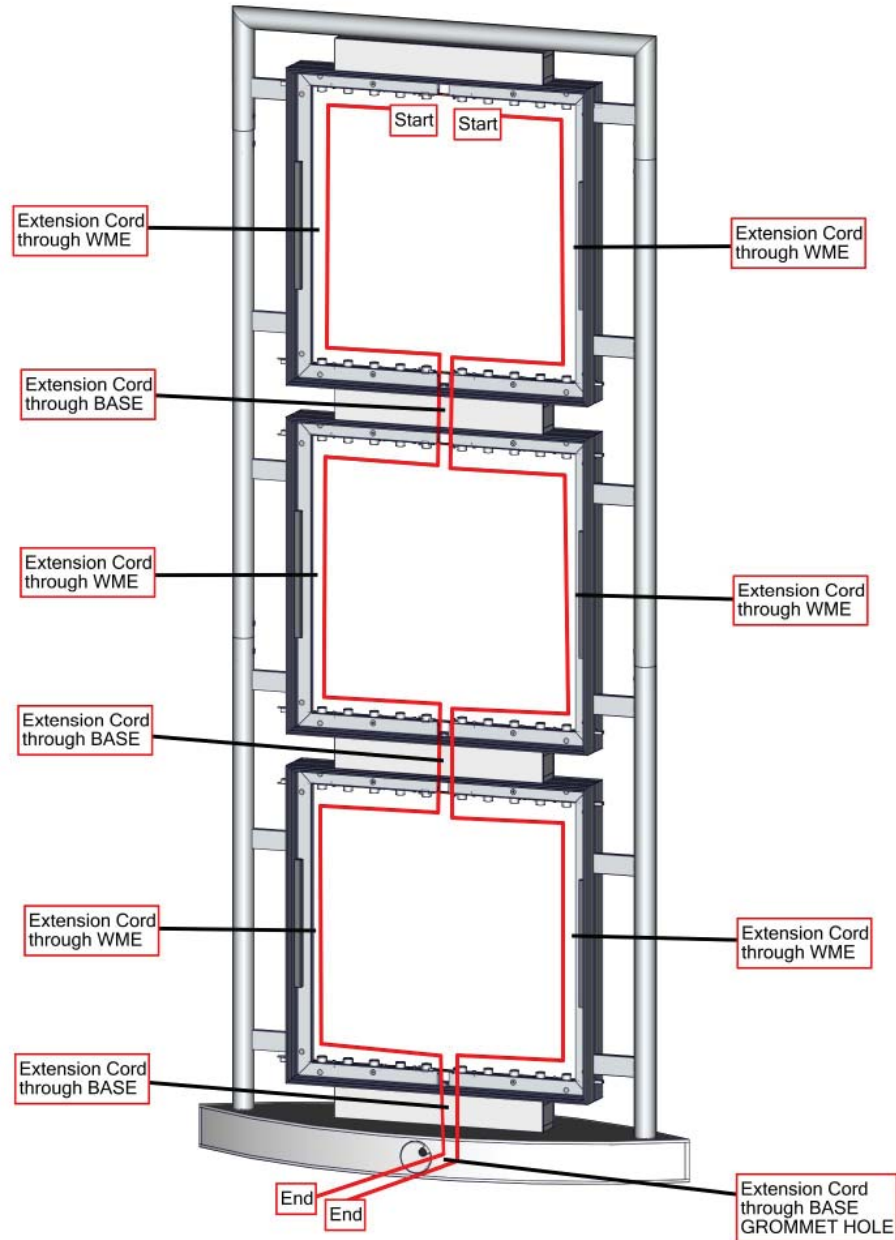

Labeling Diagram

CFAB-K-08

FRAME D x2

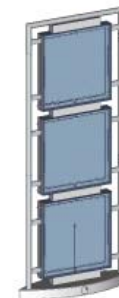
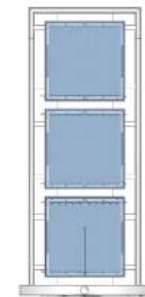
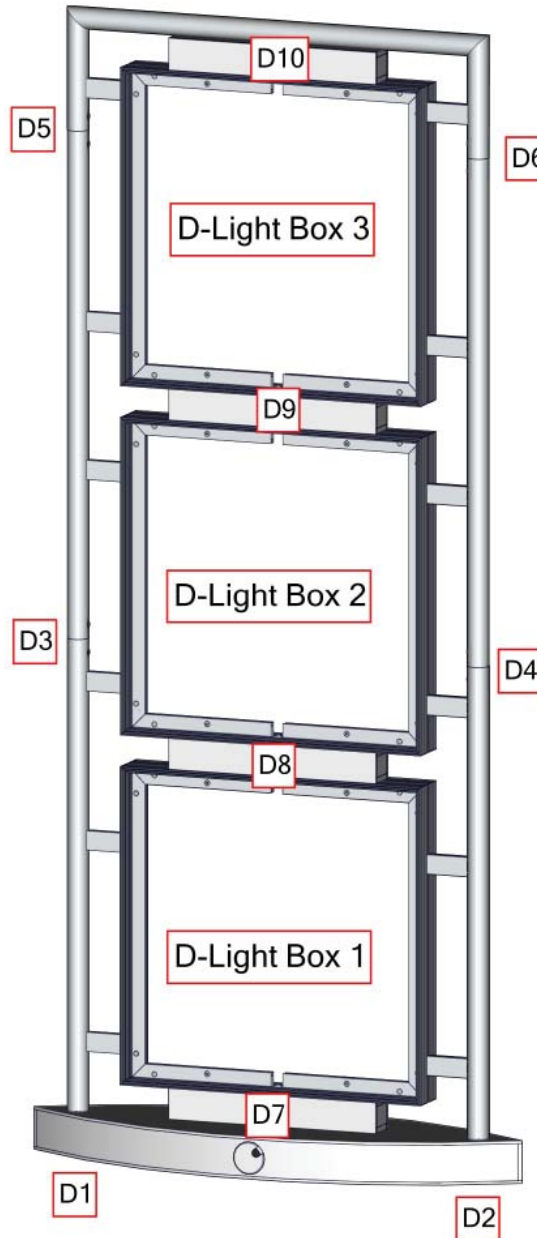

Suggested Kit Layout

CFAB-K-08

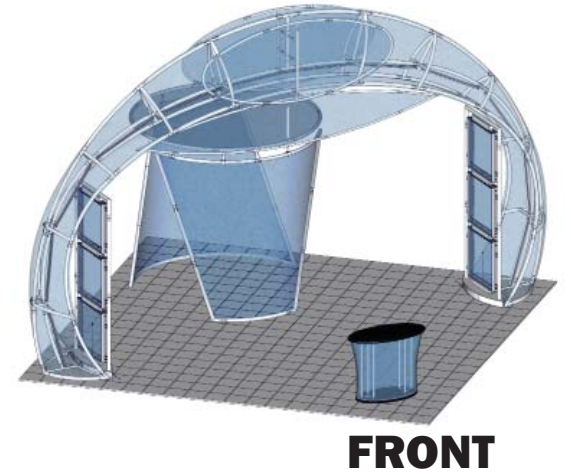
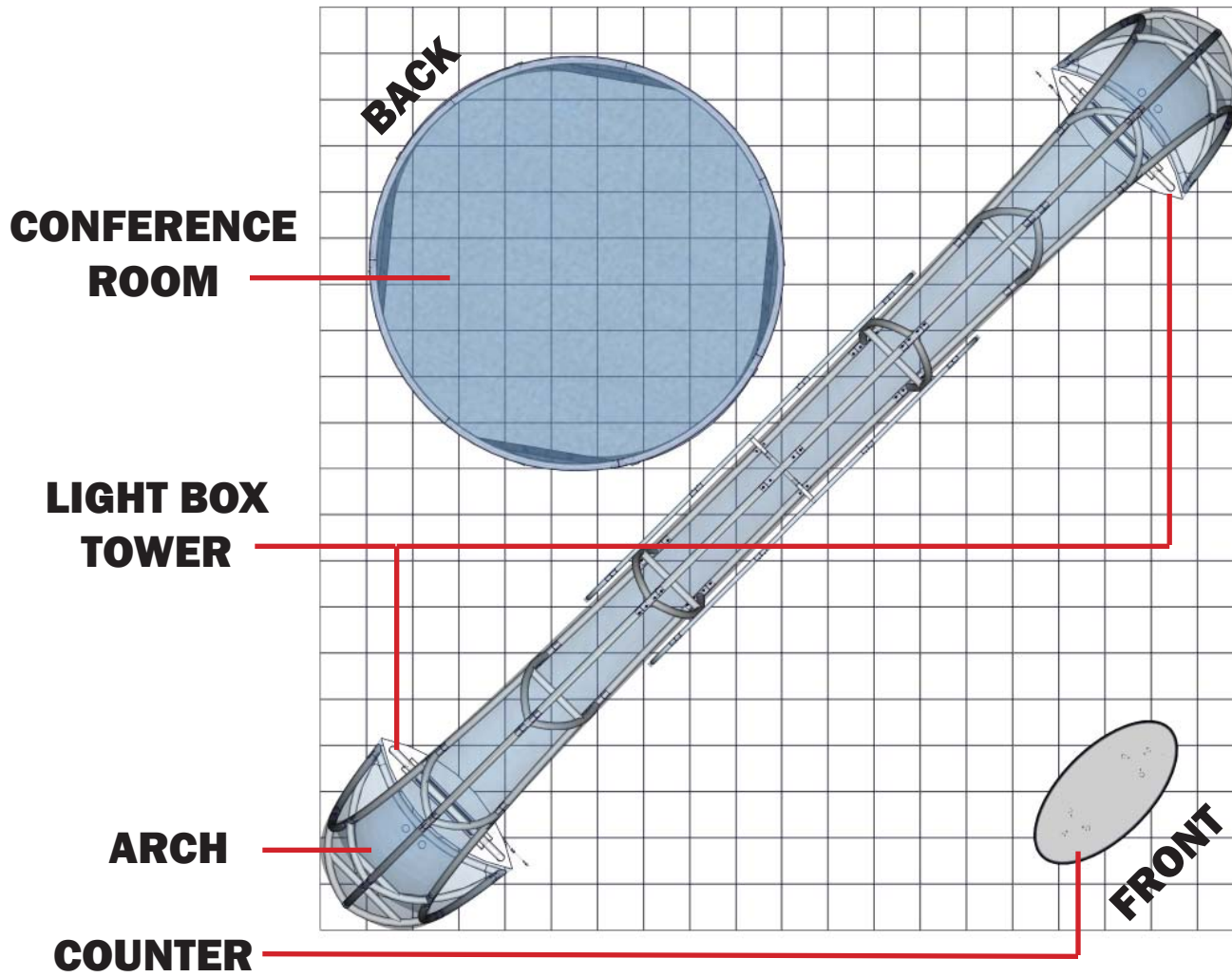

Connection Methods

Formulate® structures use a number of different yet simple connection methods. Your kit will include one or more of the connection methods shown below. Steps within the Kit Assembly will reference a specific method for each connection point.

Connection Method 1: ES30 / ES50 / ES75

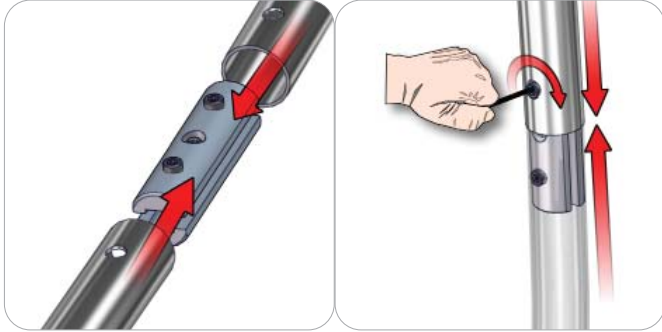

Compress the unlocked connector and slide one tube onto each end. Lock both screws carefully using your allen key tool. Be sure to lock securely, but do not overtighten.

Connection Method 2: Snap Buttons & Swage

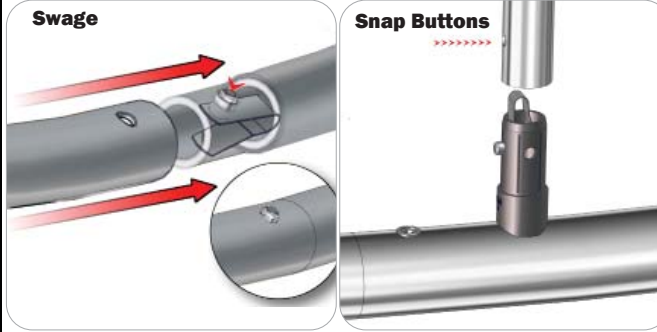

Locate the snap button on the connector or swage tube. Locate the hole on the corresponding tube. Press the snap button with your thumb and slide the tube and connector together so that the snap button snaps fully into the lock hole. To disassemble, press the snap button and pull apart.

Connection Method 3: ES30-90B / ES30-I / ES30-C

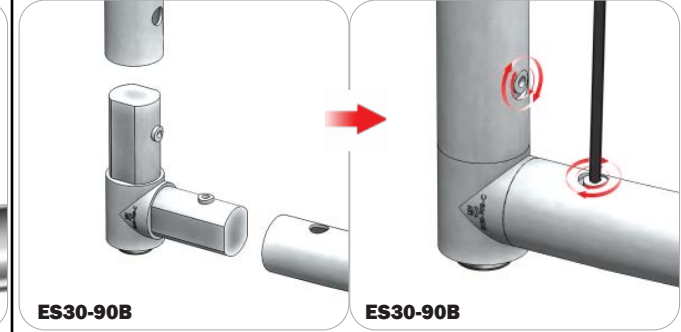

Compress one unlocked end of the connector and slide it through one tube end. Compress the other end of the connector and slide the second tube on. Lock both screws carefully using your allen key tool. Be sure to lock securely, but do not overtighten.

Connection Method 4: Tube Clamps



Be sure to fully assemble all frames before using clamps. With the clamp unlocked, place one tube of the first frame into the mouth of the clamp. Place the second tube (if applicable) into the second mouth of the clamp. With both frame's tubes in the clamp, be sure to lock securely, but do not overtighten.

Connection Method 5: Cam Lock / Slide Lock

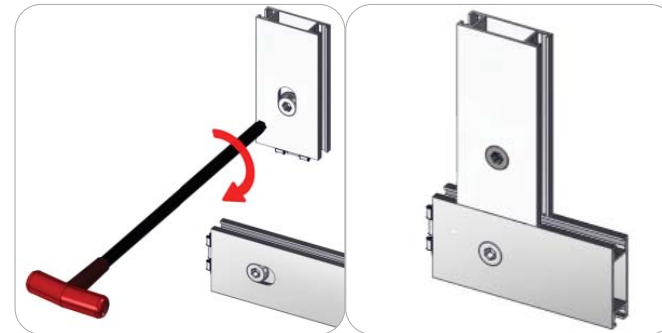

A cam lock equipped extrusion can lock to any cam lock channel. With the cam lock unlocked, set the teeth of the cam lock into the desired position on the cam lock channel. Using your allen key tool, carefully turn the lock clockwise to lock in place. Be sure to lock securely, but do not overtighten.

Kit Assembly

Step by Step

Step 1.

Gather the components to build Frame A. Assemble in the order as the Exploded Views and Labeling Diagram pages instructs.

Refer to Connection Method 1 for additional information.

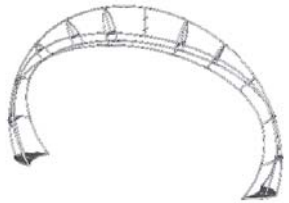

Step 2.

Locate the large graphic panel CFAB-K-08-A-G-1 and the opaque diffuser panels for Frame A. With the diffuser panels on, zip-tie the internal lights onto Frame A in the order the Internal Lighting Setup page instructs. Finally, enclose the underside of the arch with the back-lit graphic panel CFAB-K-08-A-G-2.

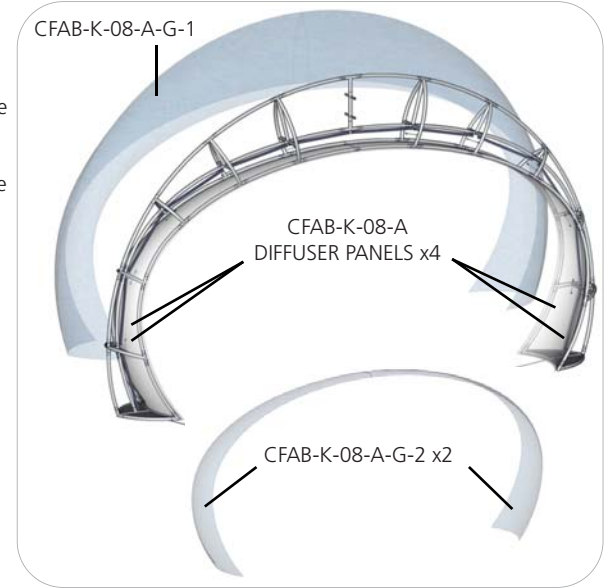
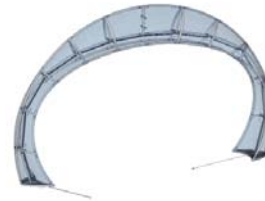

Step 3.

Gather the components to build Frame B. Assemble in the order the Exploded Views and Labeling Diagram pages instruct.

Refer to Connection Methods 1 and 2 for additional information.

Build 2 units.

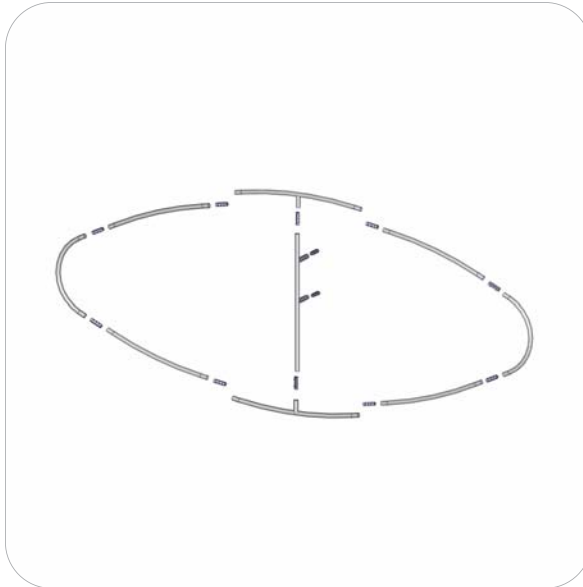
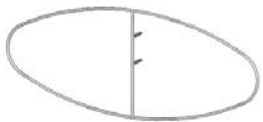

Step 4.

Locate the graphic pillowcase for Frame B. With the pillowcase unzipped, encase the frame from the bottom to the top. Zip the pillowcase fabric closed.

Build 2 units.

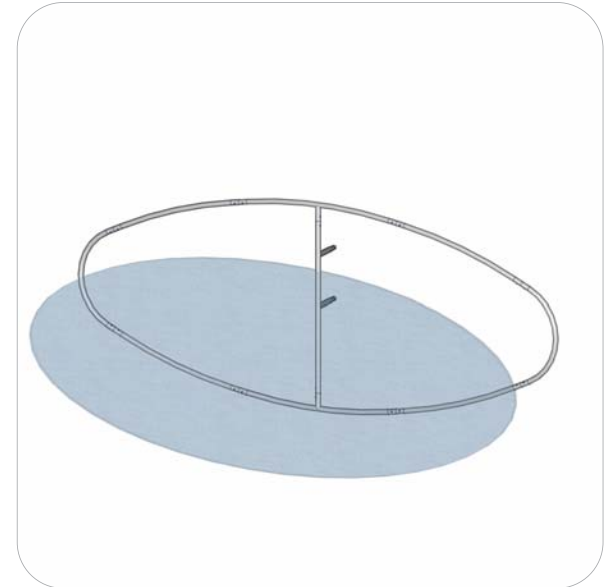

Kit Assembly

Step by Step

Step 5.

Gather the components to build Frame C. Assemble in the order as the Exploded Views and Labeling Diagram pages instruct.

Refer to Connection Methods 1 and 2 for additional information.

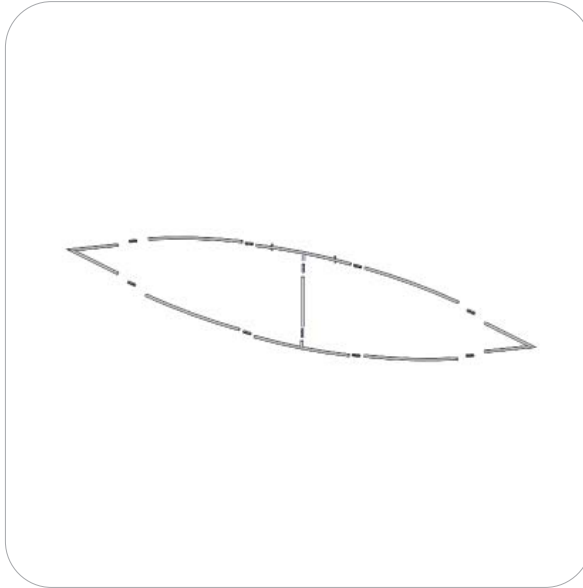

Step 6.

Locate the graphic pillowcase for Frame C. With the pillowcase unzipped, encase the frame from the bottom to the top. Zip the pillowcase fabric closed.

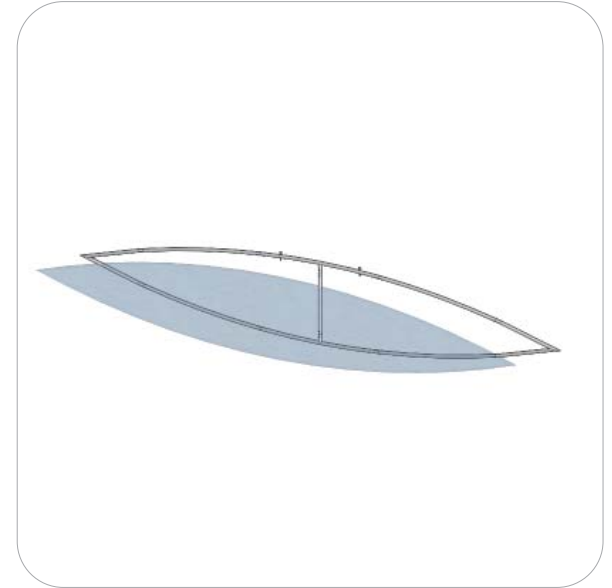

Step 7.

Gather the components to build Frame D. Assemble in the order the Exploded Views, Labeling Diagrams and Internal Lighting Setup pages instruct.

Build 2 units.

Refer to Connection Methods 1 and 5 for additional information.

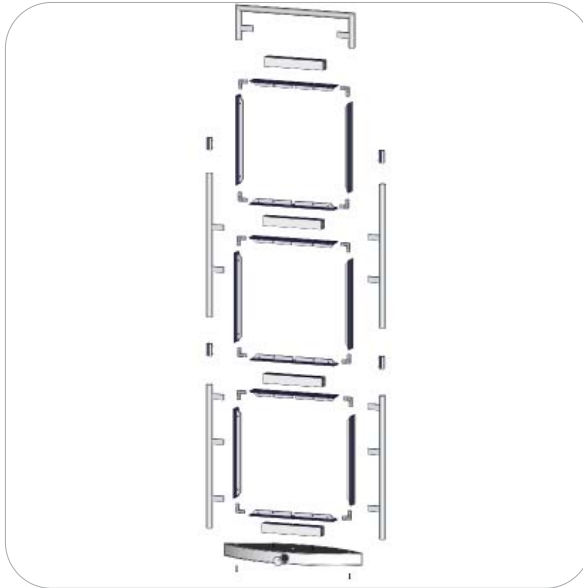
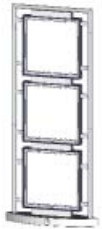

Step 8.

Locate the back-lit graphic panels for Frame D. With the frame assembled, push fit the back-lit panels into the front and back of the extrusion profile.

Build 2 units.

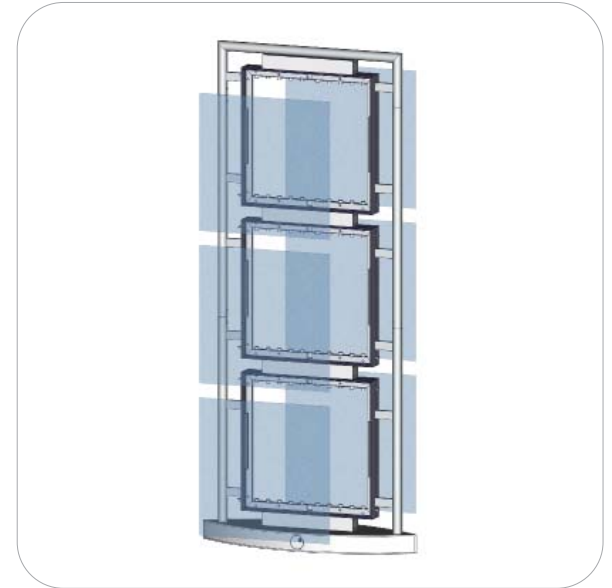
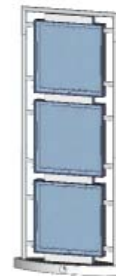

Kit Assembly

Step by Step

Step 9.

Locate the two pillow-cased Frame B assemblies and attach them onto the front and back arch of Frame A.

Refer to Connection Method 1 for additional information.

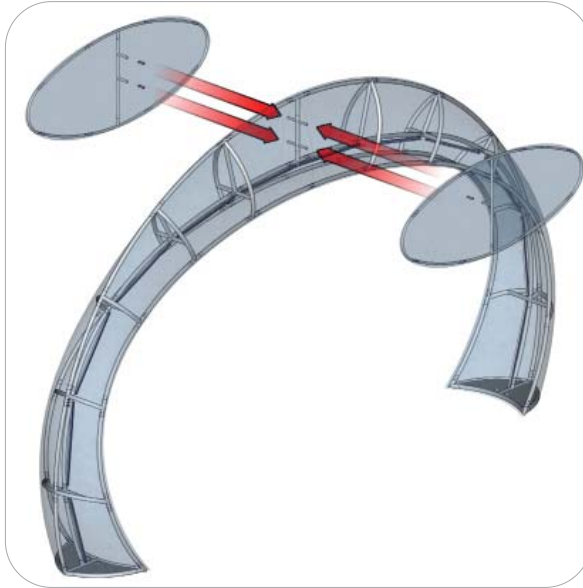

Step 10.

Locate the pillow-cased Frame C assembly and hang attach it onto the bottom arch of Frame A.



Step 11.

Locate the two Frame D assemblies and position them into the outside covers of Frame A.



Step 12.

Setup Complete.

Please reference your Conference Wall 02 and Oval Counter 05 setup instructions to complete your 20' x 20' booth space.



Formulate Conference Wall - 02

C-WALL-02

Whether you are looking to create a semi-private meeting area within a trade show exhibit, special event, or in an interior environment, Formulate® tension fabric conference walls are lightweight, stylish solutions to your meeting space needs. Ergonomically designed, Formulate C-shaped, Chip-shaped and Serpentine shaped walls combine the latest developments in fabric printed technology with gently curved 50mm aluminum frames to create private, cozy and stylish conference areas within any space.



features and benefits:

- Aluminum tube frame with snap button and spigot assembly.
- Easy to store and ship
- Quick to set up
- Three pillowcase fabric graphics
- Lifetime limited hardware warranty against manufacturer defects

dimensions:

Hardware	Graphic
<p>Assembled unit: 108"w x 102.4"h x 108"d 2743mm(w) x 2592mm(h) x 2743mm(d)</p> <p>Approximate weight: 121 lb / 54.88 kg</p>	<p>Refer to related graphic template for more information.</p> <p>Visit: www.exhibitors-handbook.com/graphic-templates</p>
Shipping	
<p>Packing case(s): 1 OCE Case</p> <p>Shipping dimensions: OCE: Expandable case length (l) may vary 40" - 66"l x 18"h x 18"d 1016mm-1677mm(l) x 458mm(h) x 458mm(d)</p> <p>Approximate total shipping weight (includes cases & graphics): 145 lb / 65.59 kg</p>	

additional information:

Graphic material:
dye-sublimation zipper pillowcase fabric

We are continually improving and modifying our product range and reserve the right to vary the specifications without prior notice. All dimensions and weights quoted are approximate and we accept no responsibility for variance. E&OE. See Graphic Templates for graphic bleed specifications.

Included In Your Kit

Tools, Components,
& Connectors



ALLEN KEY SET x1



ES50 x24

Graphics



C-WALL-02-A-G x1



C-WALL-02-B-G x1



C-WALL-02-C-G x1

Included In Your Kit

Tubes



C-WALL-02-A-T1 x1



C-WALL-02-A-T2 x1



C-WALL-02-A-T3 x1



C-WALL-02-A-T4 x1



C-WALL-02-A-T5 x1



C-WALL-02-A-T6 x1



C-WALL-02-A-T7 x1



C-WALL-02-A-T8 x1



C-WALL-02-A-T9 x1



C-WALL-02-B-T1 x1



C-WALL-02-B-T2 x1

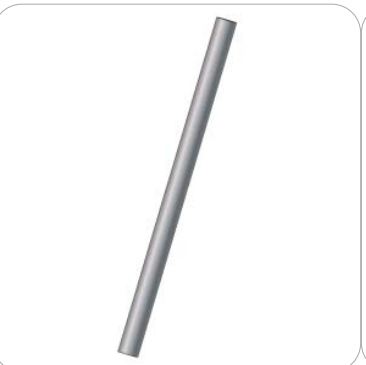

C-WALL-02-B-T3 x2



C-WALL-02-B-T4 x1



C-WALL-02-B-T5 x1



C-WALL-02-B-T6 x1

Included In Your Kit



C-WALL-02-B-T7 x1



C-WALL-02-B-T8 x1



C-WALL-02-C-T1 x1



C-WALL-02-C-T2 x4



C-WALL-02-C-T3 x1

Tubes



C-WALL-02-T8 x2



C-WALL-02-T9 x2

Exploded View

C-WALL-02

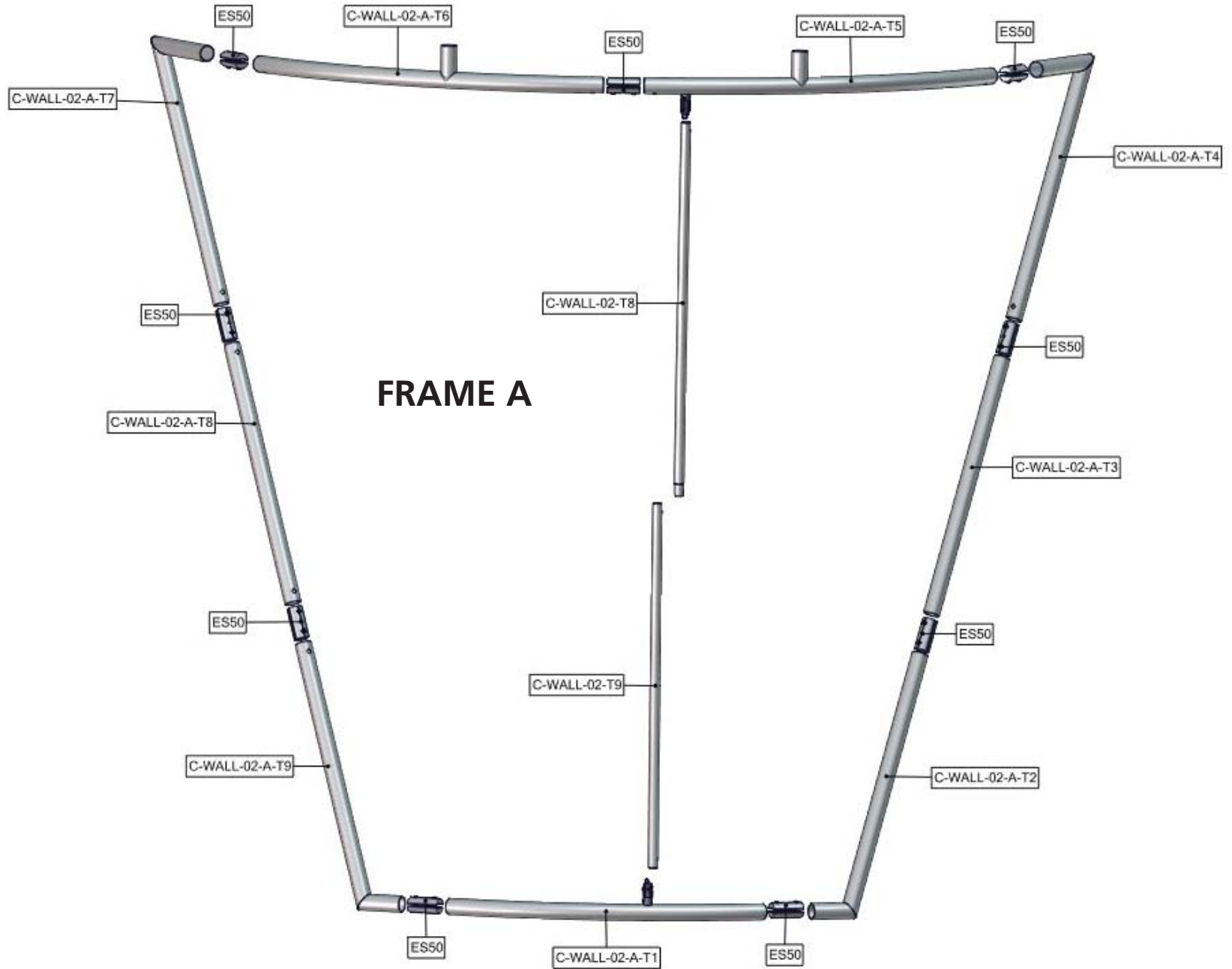

Exploded View

C-WALL-02

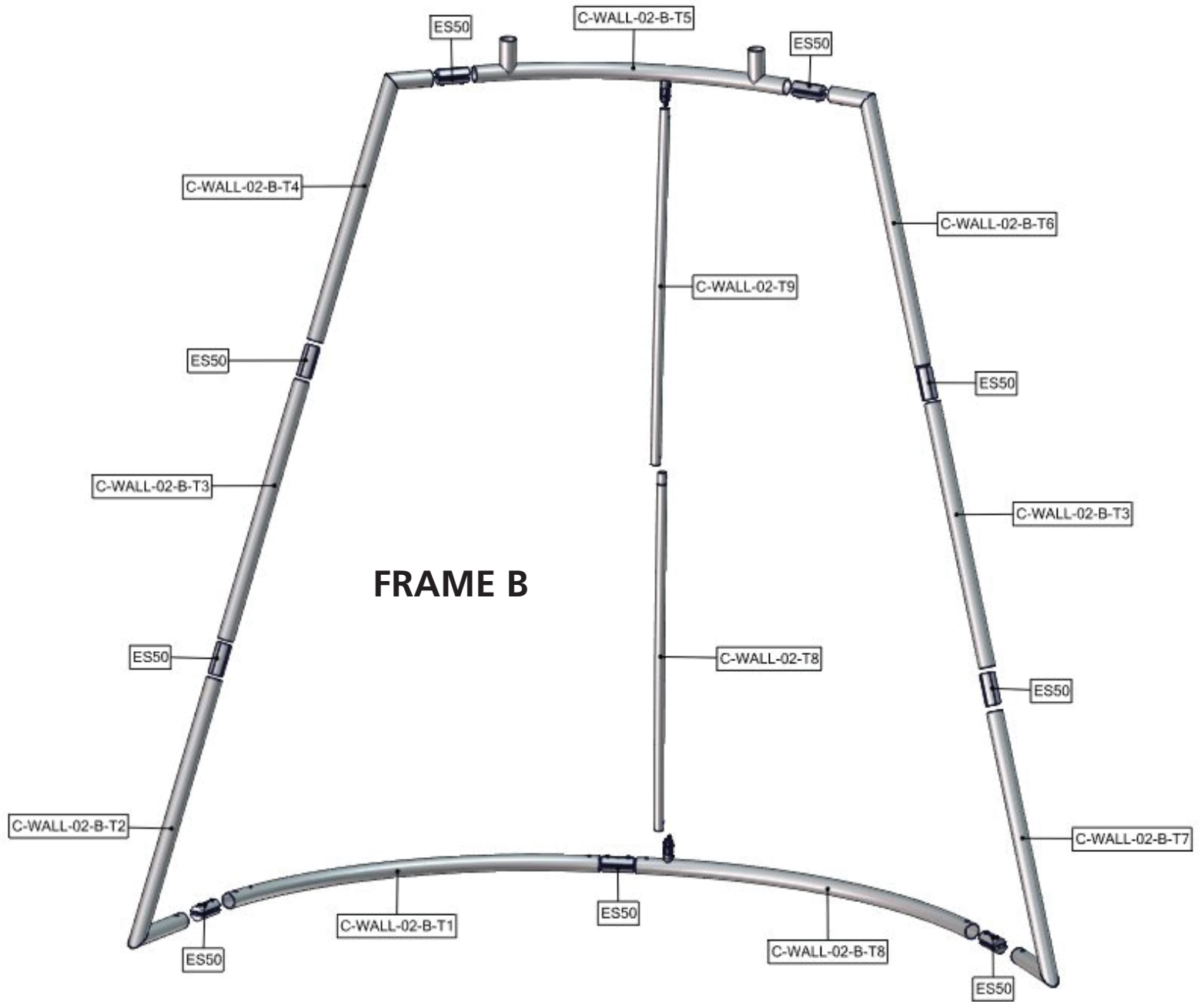

Exploded View

C-WALL-02

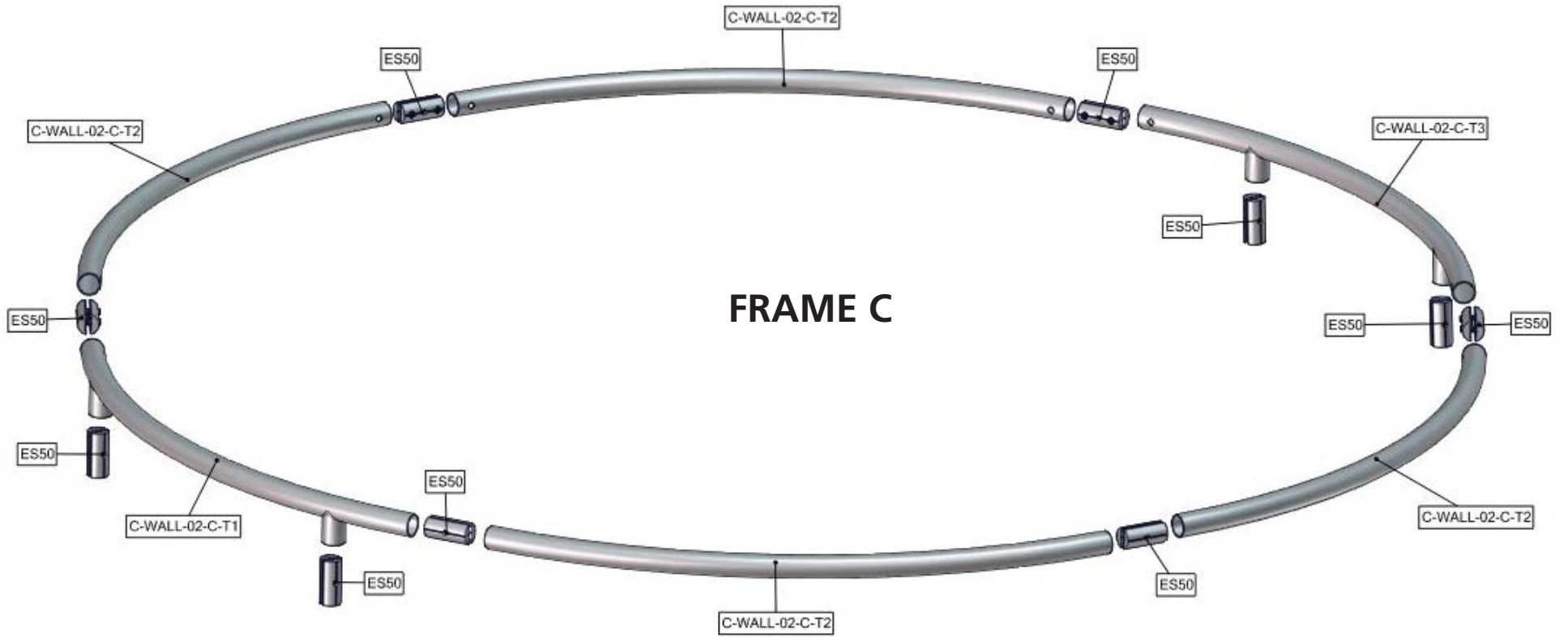

Labeling Diagram

C-WALL-02

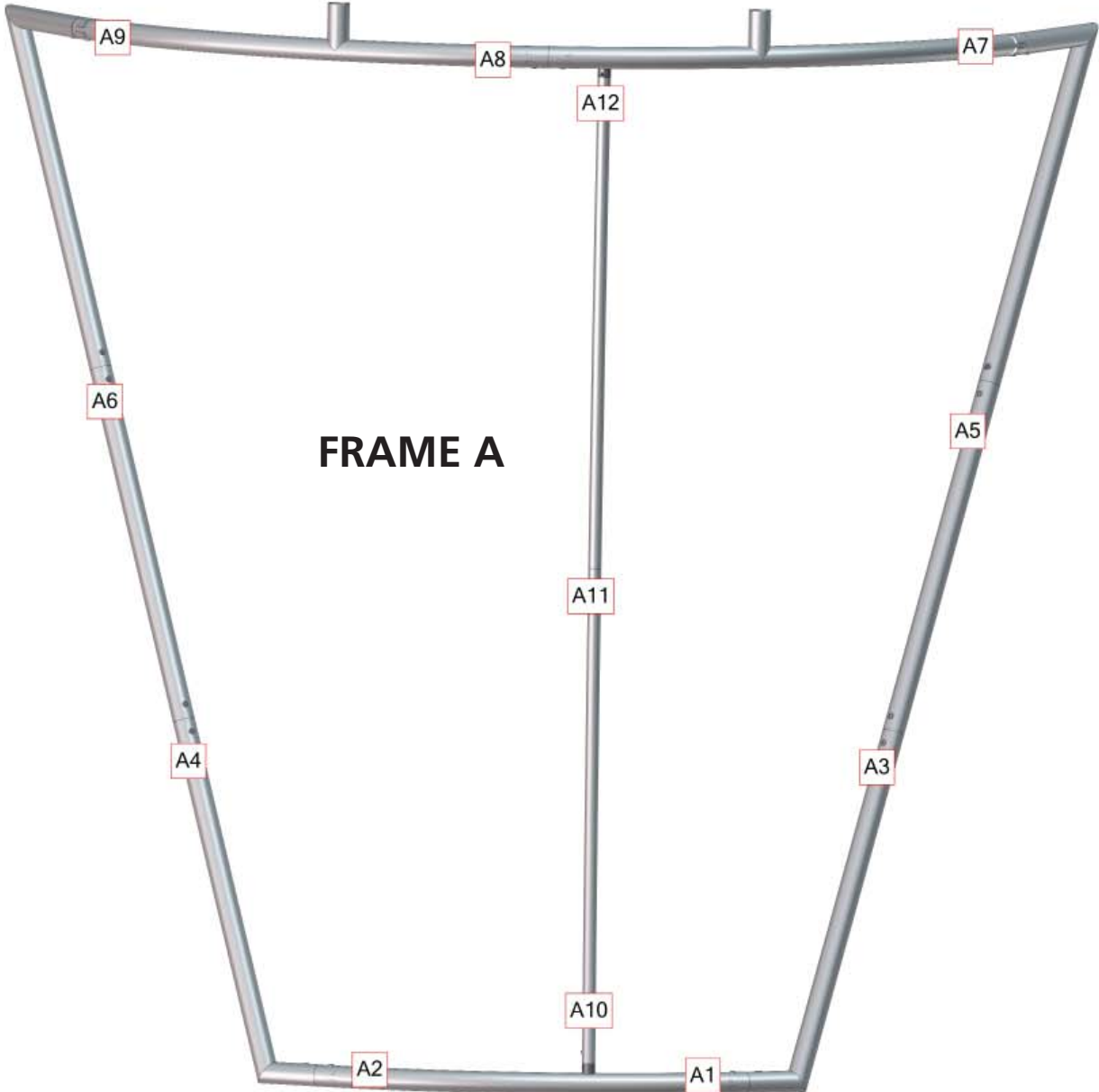

Labeling Diagram

C-WALL-02

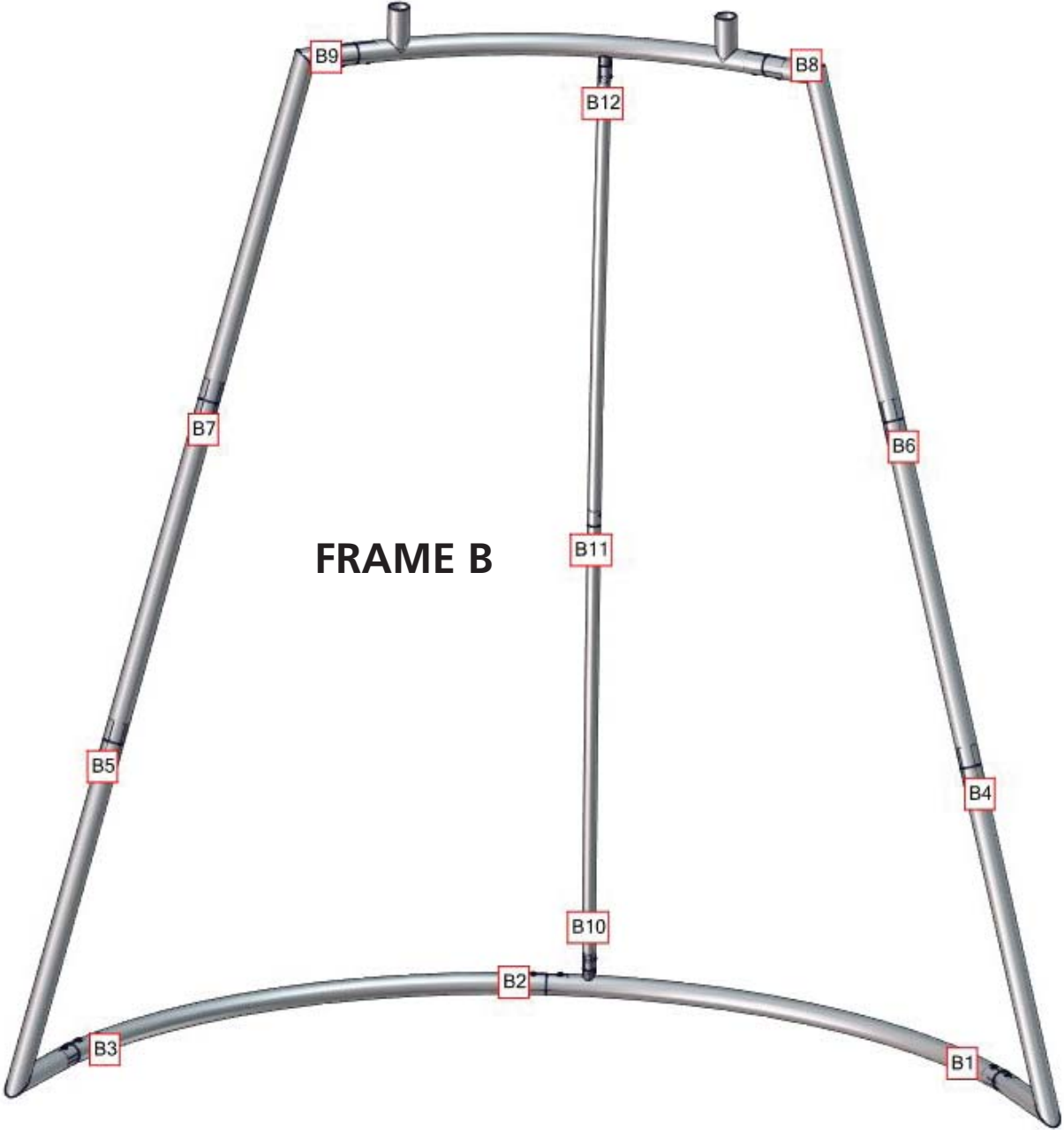

Labeling Diagram

C-WALL-02

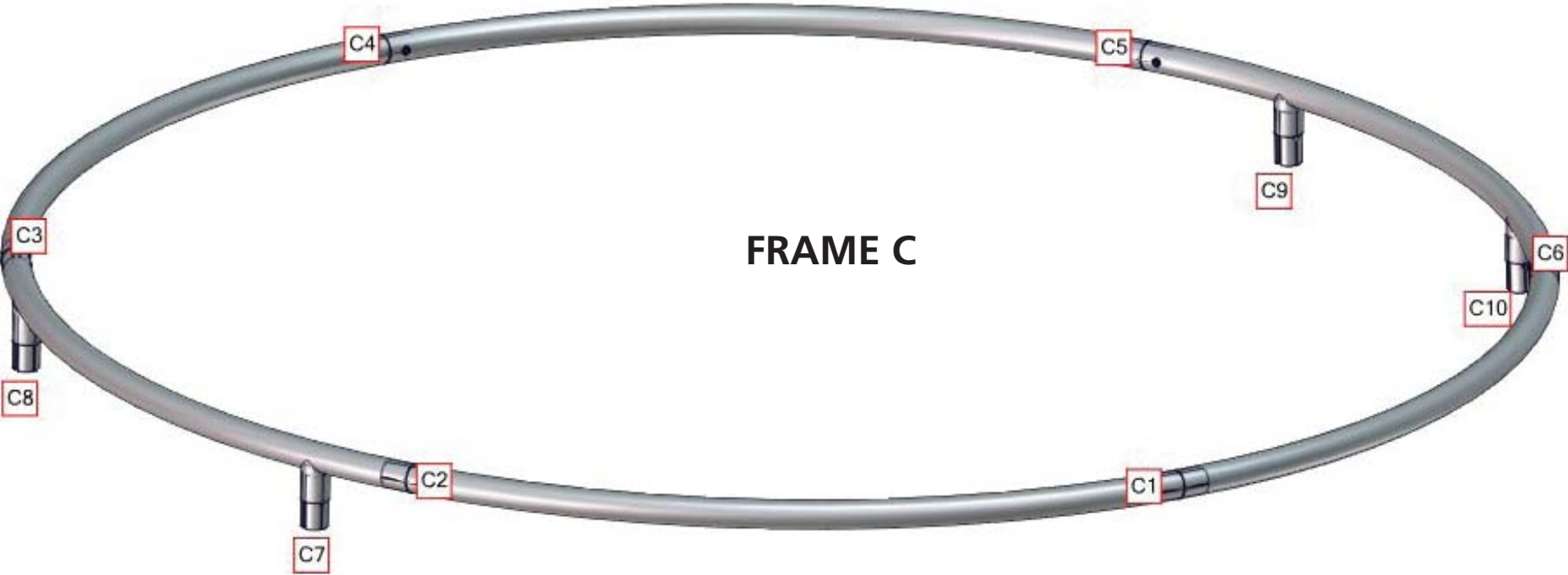

Connection Methods

Formulate® structures use a number of different yet simple connection methods. Your kit will include one or more of the connection methods shown below. Steps within the Kit Assembly will reference a specific method for each connection point.

Connection Method 1: ES30 / ES50 / ES75

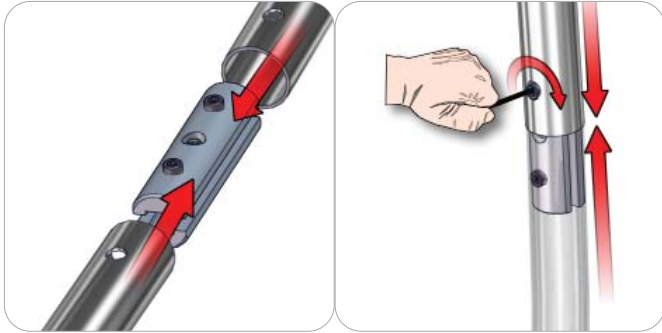

Compress the unlocked connector and slide one tube onto each end. Lock both screws carefully using your allen key tool. Be sure to lock securely, but do not overtighten.

Connection Method 2: Snap Buttons & Swage

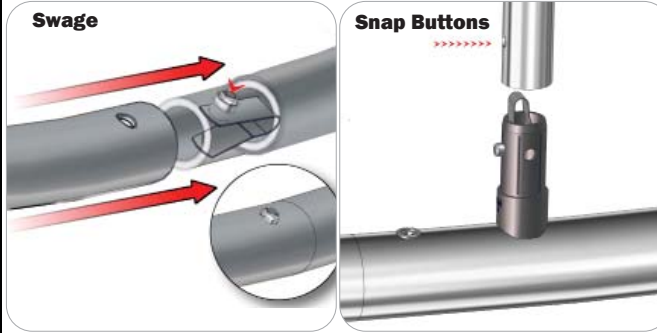

Locate the snap button on the connector or swage tube. Locate the hole on the corresponding tube. Press the snap button with your thumb and slide the tube and connector together so that the snap button snaps fully into the lock hole. To disassemble, press the snap button and pull apart.

Connection Method 3: ES30-90B / ES30-I / ES30-C

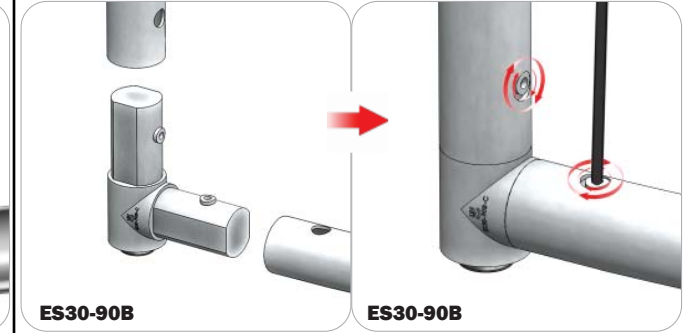

Compress one unlocked end of the connector and slide it through one tube end. Compress the other end of the connector and slide the second tube on. Lock both screws carefully using your allen key tool. Be sure to lock securely, but do not overtighten.

Connection Method 4: Tube Clamps

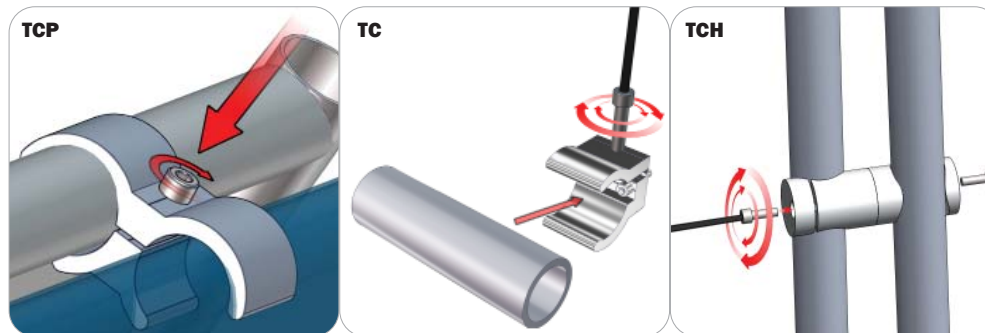

Be sure to fully assemble all frames before using clamps. With the clamp unlocked, place one tube of the first frame into the mouth of the clamp. Place the second tube (if applicable) into the second mouth of the clamp. With both frame's tubes in the clamp, be sure to lock securely, but do not overtighten.

Kit Assembly

Step by Step

Step 1.

Locate the components necessary for assembling Frame A referenced in the exploded view. Assemble the frame in order according to the Labeling Diagram.

Please reference Connection Method 1 for more details.



Step 2.

Apply graphic to Frame A. For ease of installation, pull the fabric cover from the bottom to the top of the frame while the frame rests flat on the floor. Zip to enclose.



Bottom Of Frame

Step 3.

Locate the components necessary for assembling Frame B referenced in the exploded view. Assemble the frame in order according to the Labeling Diagram.

Please reference Connection Method 1 for more details.



Step 4.

Apply graphic to Frame B. For ease of installation, pull the fabric cover from the top to the bottom of the frame while the frame rests flat on the floor. Zip to enclose.



Bottom Of Frame

Kit Assembly

Step by Step

Step 5.

Locate the components necessary for assembling Frame C referenced in the exploded view. Assemble the frame in order according to the Labeling Diagram.

Please reference Connection Method 1 for more details.



Step 6.

Apply graphic to Frame C. Pull the fabric cover over frame while the frame rests flat on the floor. Zip to enclose.



Step 7.

Place frame C above frame A and B, and attach using connection method 1.

Assembly complete.



Formulate Counter – Oval

W-05-C

Formulate® counters couple lightweight hardware with printed stretch silicone edge fabric graphics (SEG) to create funky and functional reception stands. Tables and bases are available in four colored finishes – silver, black, mahogany and natural.



features and benefits:

- Printed stretch silicone edge fabric graphics (SEG) for a custom look
- Counter supports 25 lbs. of weight on center
- Choice of four finishes for table and base
- Kit includes: one frame, one dye-sublimated graphic, table and base, and one wheeled molded OCH2 storage case
- Lifetime hardware warranty against manufacturer defects

dimensions:

Hardware	Graphic
<p>Assembled unit: 47.25" w x 38" h x 23.75" d 1200mm(w) x 970mm(h) x 600mm(d)</p> <p>Approximate kit weight (includes graphic): 53 lbs / 24 kgs</p>	<p>Refer to related graphic template for more information.</p> <p>Visit: www.exhibitors-handbook.com/graphic-templates</p>
<p>Shipping</p> <p>Shipping dimensions: 1x OCH2 case: 50" l x 30" w x 15" h</p> <p>Approximate shipping weight: (kit and case) 85 lbs / 38.55 kgs</p>	

additional information:

Graphic material:
Dye-sublimated fabric

Wood finish options:



silver black mahogany natural



www.display-setup-animations.com

We are continually improving and modifying our product range and reserve the right to vary the specifications without prior notice. All dimensions and weights quoted are approximate and we accept no responsibility for variance. E&OE. See Graphic Templates for graphic bleed specifications.

Included In Your Kit

Tools, Components, & Connectors



ALLEN KEY SET x1



TRI30-COUNTER x2

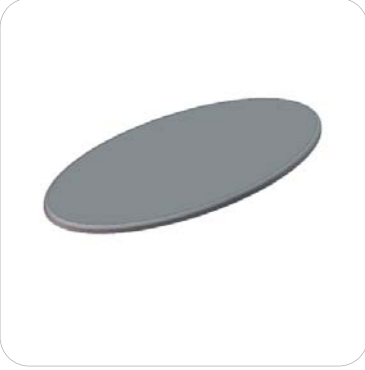

W-01-C-TOP x1

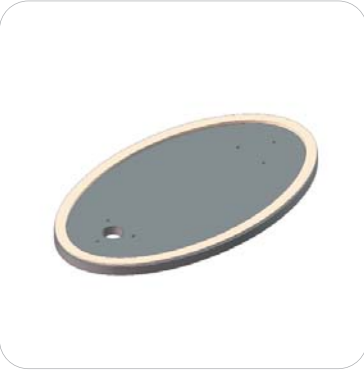

W-01-C-BASE x1



5/16-18 Flanged Wing Nut x12



5/16-18-2 Full Threaded Set Screw x12

Graphics



W-05-C-G x1

Exploded View

W-05-C

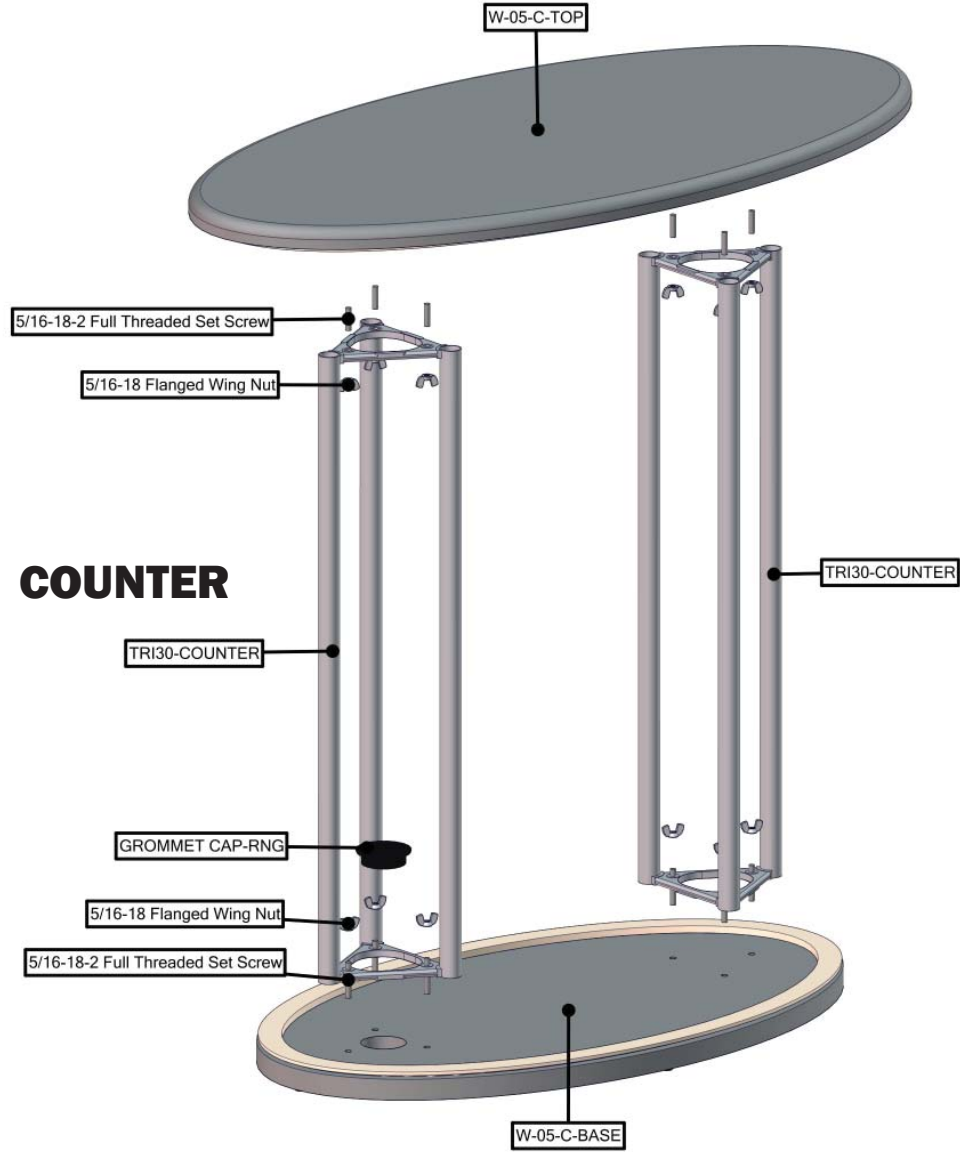

Kit Assembly

Step by Step

Step 1.

Begin by threading your 2" studs through the holes of the base. Attach your TRI30-COUNTER support beam and secure using (3) wing nuts.

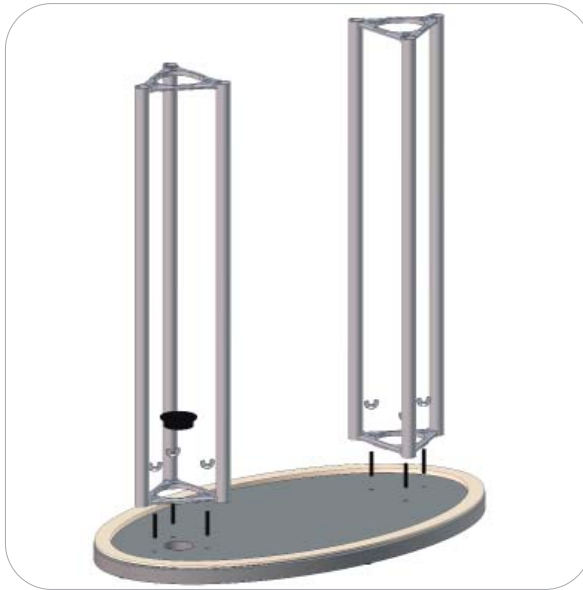

Step 2.

Pull your graphic over TRI30-COUNTER beams and push the edges into the seams of the base.



Step 3.

Thread the 1.25" studs into the counter top. Align the counter top so that the studs fall through the holes of the TRI30-COUNTER beam. Secure the counter top using the remaining (3) wing nuts.



Step 4.

Push the top edges of the graphic into the seams of the counter top to complete your assembly.

Setup Complete.

