

Formulate Fabric Kiosk 04

Formulate Kiosks combine lightweight aluminum tube frames with state-of-the-art printed stretch zipper pillowcase fabric graphics to create funky and functional multimedia kiosks.



features and benefits:

- Premium aluminum tube frame with spigot assembly
- Easy to store and ship
- Quick to set up
- Pillowcase fabric graphic
- Kit includes: aluminum frame, wooden cabinet with door and a large monitor mount
- Lifetime limited hardware warranty against manufacturer defects

dimensions:

Hardware	Graphic
Assembled unit: 42.13" w x 96" h x 25.59" d 1071mm(w) x 2439mm(h) x 650mm(d)	Refer to related graphic template for more information. Visit: www.tradeshowplus.com
Approximate weight: 193 lbs / 88 kgs	

Shipping

Packing case(s):
1 OCH2
1 OCFM

Shipping dimensions:
OCH2:
52" l x 29" h x 15" d
1321mm(l) x 737mm(h) x 381mm(d)

OCFM:
49" l x 38" h x 15" d
1245mm(l) x 966mm(h) x 381mm(d)

Approximate total shipping weight (includes cases & graphics):
199 lbs / 91 kgs

additional information:

Graphic material:
Dye-sublimation zipper pillowcase fabric

Large monitor mount, can hold 40" - 65" monitor with a max weight of 40 lbs.

Frame A and Cabinet stand independently of one another, no connection hardware required.

When included in a larger kit, a different packaging solution will be listed to accommodate all contents of the kit. Individual packaging no longer provided.

Panel Colors:



Tabletop Colors:

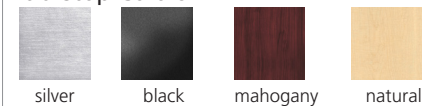

We are continually improving and modifying our product range and reserve the right to vary the specifications without prior notice. All dimensions and weights quoted are approximate and we accept no responsibility for variance. E&OE. See Graphic Templates for graphic bleed specifications.

Included In Your Kit

Tools, Components, & Connectors



ALLEN KEY SET x1

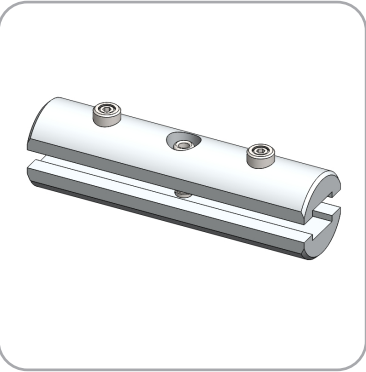

ES30 x20

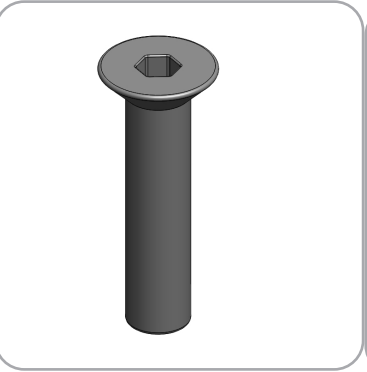

LN114-SCRW x2

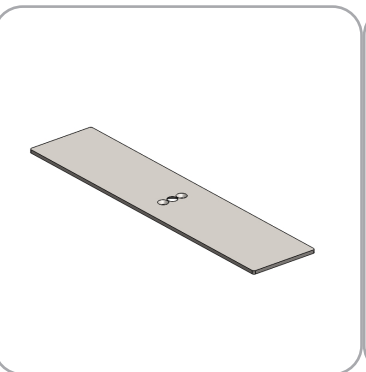

PLT-BP-LN114-S2-650 x2



TUBE-LG-MB x1

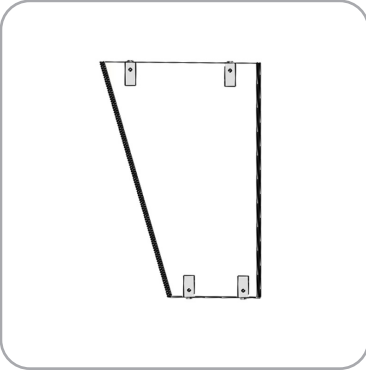

PNL-FMLT-KIOSK-04-L-1 x1

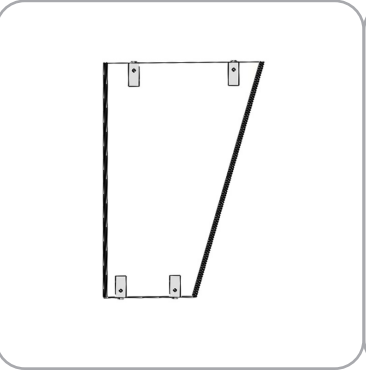

PNL-FMLT-KIOSK-04-R-1 x1



CT-FMLT-KIOSK-04 x1



BASE-FMLT-KIOSK-04 x1



PM3R8-1000-L-L x1

Graphics

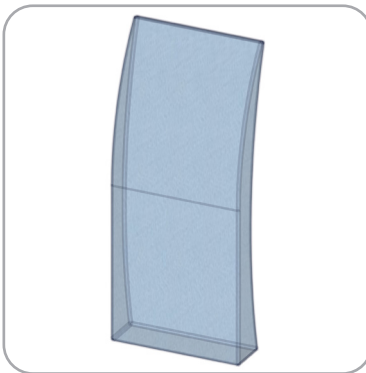

FMLT-KIOSK-04-A-G x1

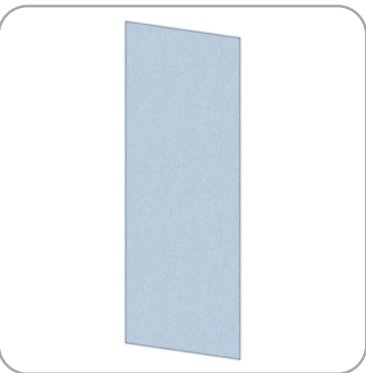

FMLT-KIOSK-04-B-G x1

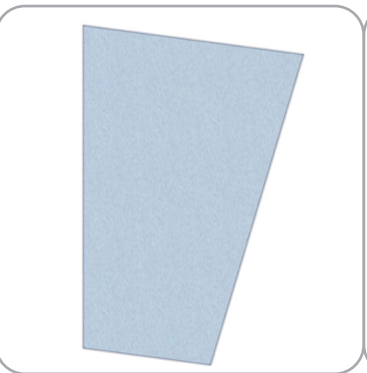

FMLT-KIOSK-04-C-G x1

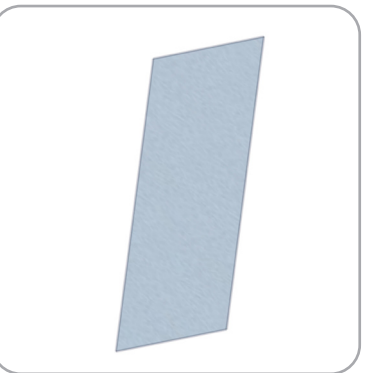

FMLT-KIOSK-04-D-G x1

Included In Your Kit

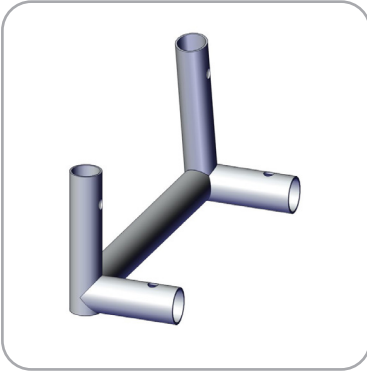

KIOSK-04-T1 x1

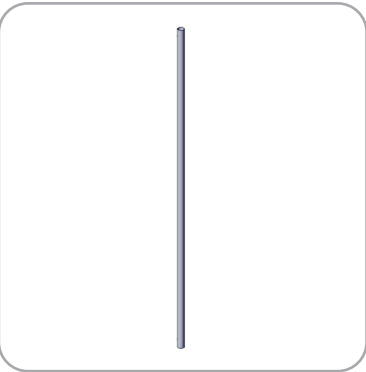

KIOSK-04-T2 x2



KIOSK-04-T3 x2



KIOSK-04-T4 x1



KIOSK-04-T5 x1

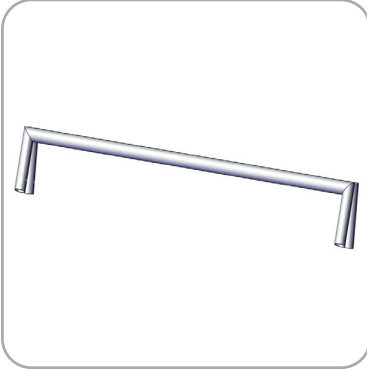

KIOSK-04-T6 x1



KIOSK-04-T7 x4

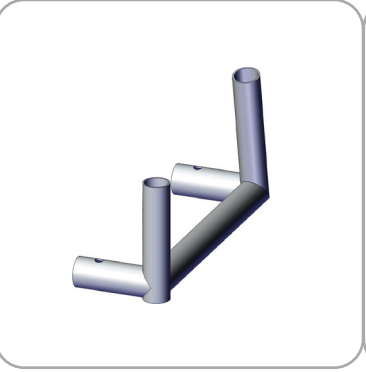

KIOSK-04-T10 x1

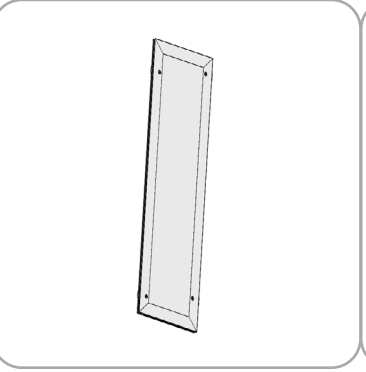

LP-CD-300-1000 x1

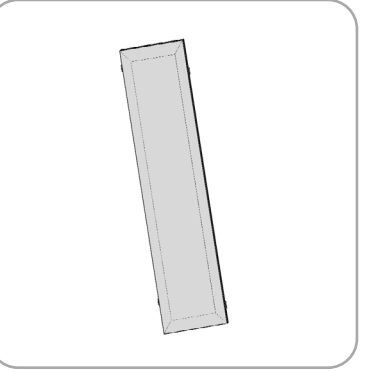

LP-300-1035 x1

Tubes & Components

Exploded View

FMLT-KIOSK-04
Frame

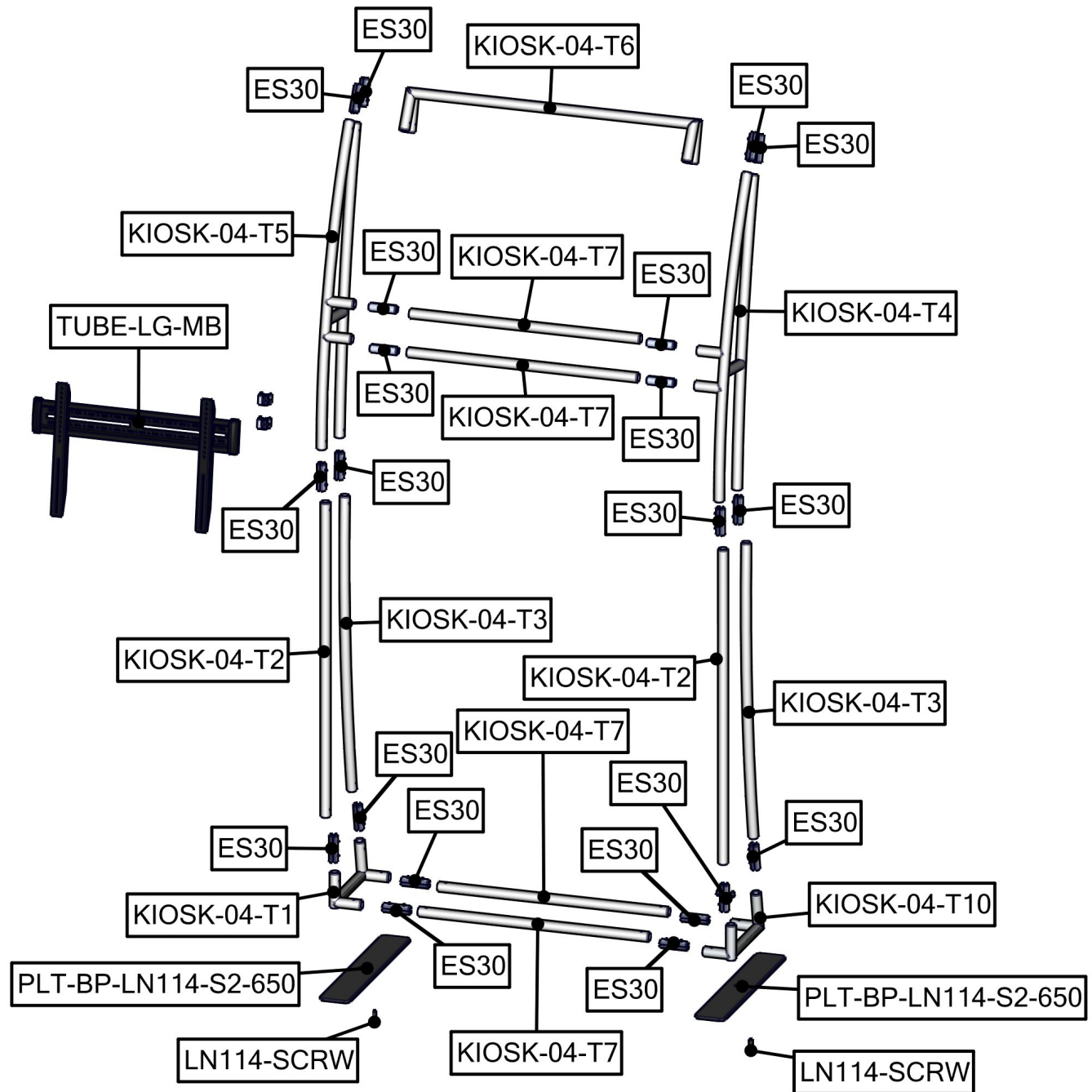

Labeling Diagram

FMLT-KIOSK-04
Frame

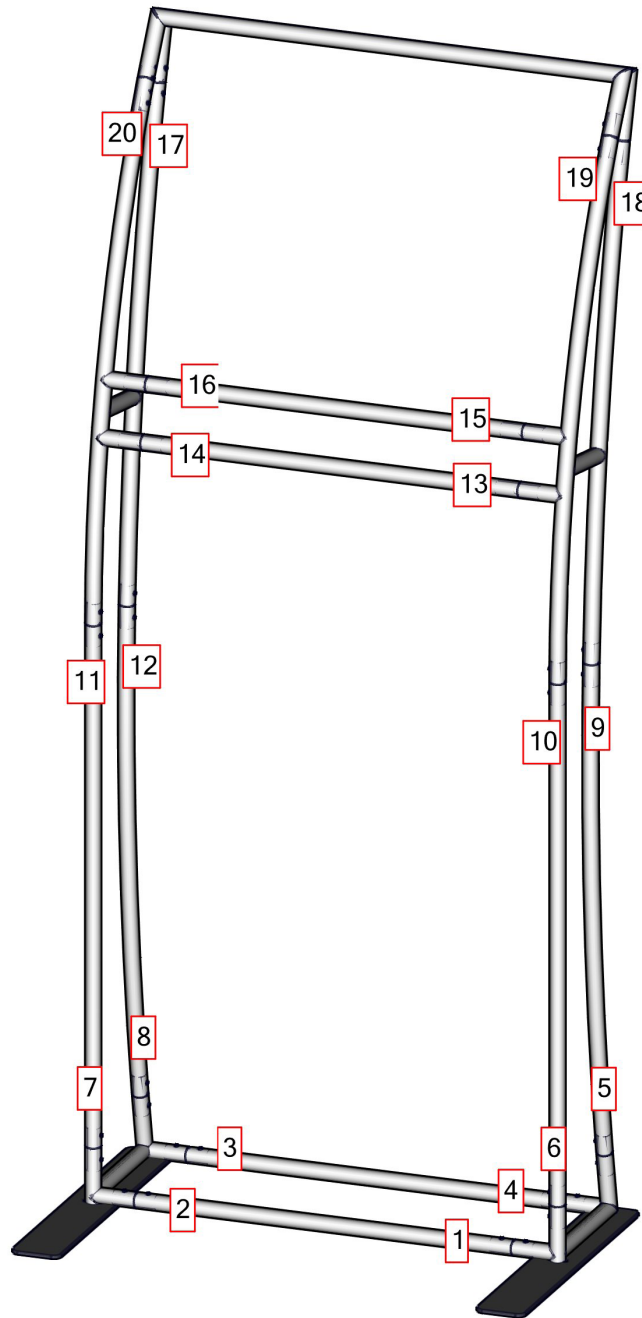

Exploded View

FMLT-KIOSK-04
Cabinet

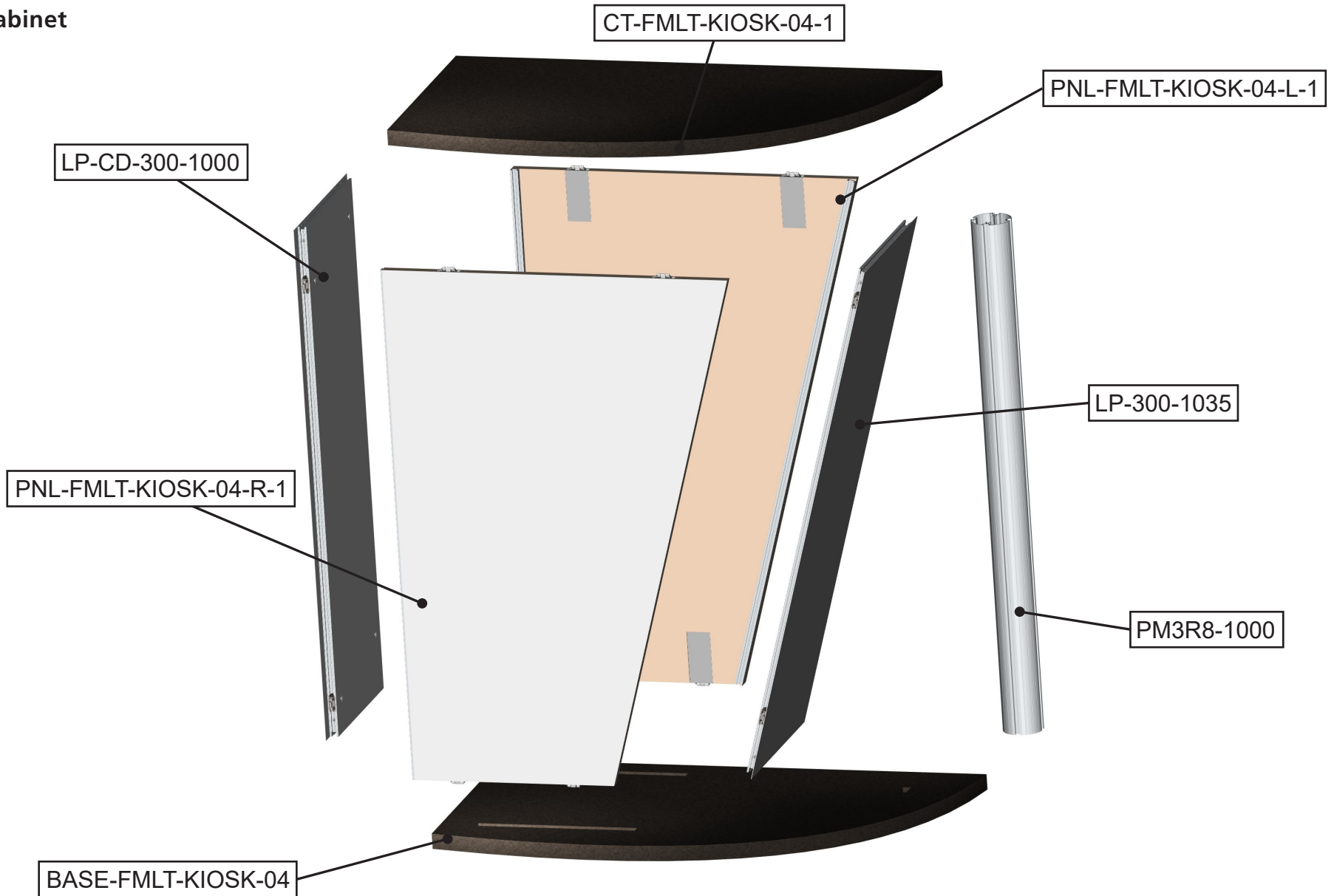

Frame A and Cabinet stand independently of one another, no connection hardware required.

Connection Methods

Connection Method 1: ES30 / ES50 / SNAP BUTTONS

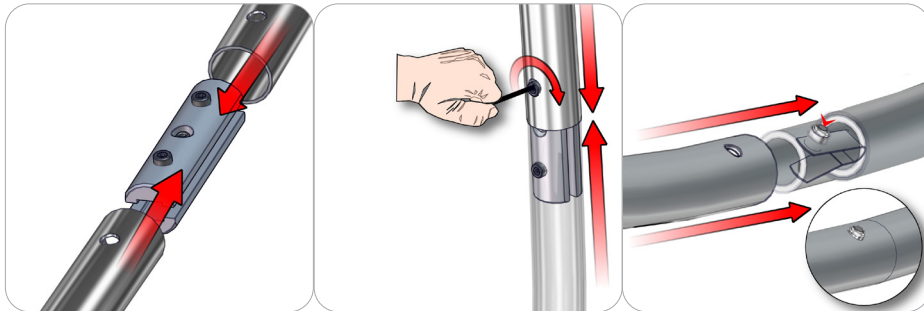

For spigot connections, compress the unlocked connector and slide into the tube lock access hole. Lock both screws carefully using your allen key tool. Be sure to lock securely, but do not over tighten. For snap button connections, locate the snap button on the connector or swage tube. Locate the hole on the corresponding tube. Press the snap button with your thumb and slide the tube and connector together so that the snap button snaps fully into the lock hole. To disassemble, press the snap button and pull apart.

Connection Method 4: CAM LOCK



First, with the cam lock disengaged, place the cam lock teeth into the extrusion channel. Second, use the allen key tool to lock it in place. Make half turns clock-wise to engage the cam lock. Do not over tighten the lock buttons.

Kit Assembly

Step by Step

Step 1.

Gather the components to build the frame. Use the Exploded View and the Labeling Diagram for part labels.

Reference Connection Method(s) 1 for more details.

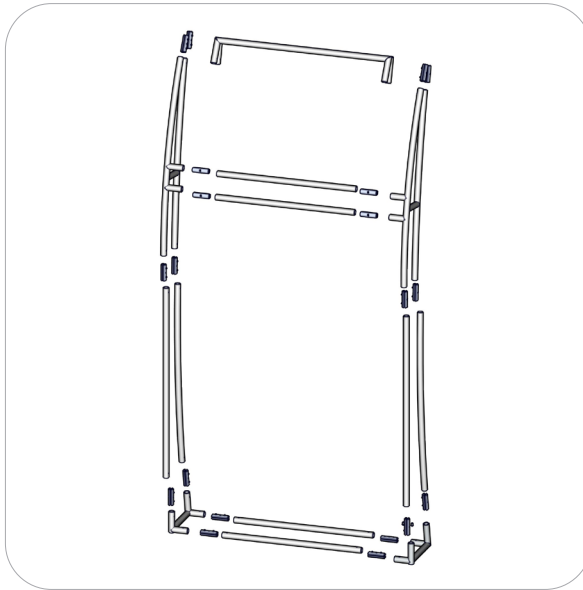

Step 2.

With the frame laid out flat on the floor, apply the pillowcase over the frame and zipper it closed at the bottom.

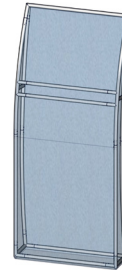

Step 3.

Gather the components and provided allen key tool to stabilize the frame. Use the Exploded View and the Labeling Diagram for part labels.

Reference Connection Method(s) 2 for more details.



Step 4.

Gather the components for attaching the monitor mount bracket onto the frame.

Reference the monitor mount supplement sheets for more details.

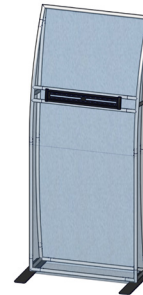

Kit Assembly

Step by Step

Step 5.

Gather the components to attach the sides of the cabinet and the extrusion to the base. Use the Exploded View for labels.

Reference Connection Method(s) 2 for more details.



Step 6.

Using the provided handtool, attach the remaining panels as shown in the diagram to the right. Use the Exploded View and the Labeling Diagram for part labels.

Reference Connection Method(s) 2 for more details.



Step 7.

Open the left panel cabinet door to access and attach the counter top from the inside. Use the Exploded View and the Labeling Diagram for part labels.

Reference Connection Method(s) 2 for more details.



Step 8.

Attach your monitor display onto the monitor bracket and simply move your counter in front of the frame.

Setup is complete.

